

Draft dated March 10, 2008

HADRONIC MATHEMATICS, MECHANICS AND CHEMISTRY

**Volume IV:
Experimental Verifications, Theoretical Advances and
Industrial Applications in Particle Physics,
Nuclear Physics and Astrophysics**

Ruggero Maria Santilli

CV: <http://www.i-b-r.org/Ruggero-Maria-Santilli.htm>

Institute for Basic Research

P. O. Box 1577, Palm Harbor, FL 34682, U.S.A.

ibr@gte.net, <http://www.i-b-r.org>

<http://www.neutronstructure.org>

<http://www.magnegas.com>

International Academic Press

Copyright ©2007 owned by Ruggero Maria Santilli
P. O. Box 1577, Palm Harbor, FL 34682, U.S.A.

All rights reserved.

This book can be reproduced in its entirety or in part, or stored in a retrieval system or transmitted in any form, provided that the source and its paternity are identified fully and clearly. Violators will be prosecuted in the U. S. Federal Court and the lawsuits will be uploaded in the web site
<http://www.scientificethics.org>

U. S. Library of Congress

Cataloguing in publication data:

Santilli, Ruggero Maria, 1935 -

Foundations of Hadronic Mathematics

Mechanics and Chemistry

Volume II:

*Experimental Verifications, Theoretical Advances,
and Industrial Applications in Particle Physics,
Nuclear Physics and Astrophysics*

with

Bibliography and

Index

Additional data supplied on request

ISBN Number xxxxxxxxxxxx

INTERNATIONAL ACADEMIC PRESS

This volume is dedicated to the memory of

Don Carlo Borghi

*because he found strength in his Christian faith to oppose organized academic,
financial and ethnic interests disrupting experiments on the laboratory synthesis
of the neutron because contrary to Einsteinian doctrines.*

Contents

Foreword	x
Preface	xiii
Legal Notice	xv
Acknowledgments	xvii
6. EXPERIMENTAL VERIFICATIONS AND APPLICATIONS IN PARTICLE PHYSICS, ASTROPHYSICS AND COSMOLOGY	807
6.1 EXPERIMENTAL VERIFICATIONS IN CLASSICAL AND PARTICLE PHYSICS	807
6.1.1 Introduction	807
6.1.2 Space, the Final Frontier of Knowledge	808
6.1.3 The Far Reaching Implications of Space as a Universal Medium	812
6.1.4 Rudiments of Santilli Isorelativity	815
6.1.5 Rudiments of Hadronic Mechanics	828
6.1.6 Catastrophic Mathematical and Physical Inconsistencies of Noncanonical and Nonunitary Theories	831
6.1.7 Experimental Verifications for Arbitrary Speeds of Light	834
6.1.8 Experimental Verifications in the Interior of Hadrons	841
6.1.9 Experimental Verifications with the Behavior of the Meanlives of Unstable Hadrons with Speed	846
6.1.10 Experimental Verifications via the Bose-Einstein Correlation	852
6.1.10.A The Unavoidable Nonlocal and Non-Hamiltonian character of the Correlation	852
6.1.10.B Conventional treatment of the Bose-Einstein correlation	854
6.1.10.C Incompatibility of the Bose-Einstein correlation with Relativistic Quantum Mechanics	856
6.1.10.D Representation of the Bose-Einstein correlation via relativistic hadronic mechanics	857
6.1.10.E Reconstruction of the Exact Poincaré Symmetry under Nonlocal and Non-Hamiltonian interactions of the Bose-Einstein Correlation	861
6.1.10.F Theoretical Predictions	864

	6.1.10.G Experimental verifications	866
	6.1.11 Experimental Verifications in Astrophysics	869
	6.1.12 Verification via the Absence of Dark Matter and Energy	873
	6.1.13 Experimental Verifications via Supernova Explosions	880
	6.1.14 Verifications via the Bose-Einstein Condensation	883
	6.1.15 Verification in Cosmology	885
6.2	HADRONIC STRUCTURE MODELS WITHOUT QUARKS AND NEUTRINOS	892
	6.2.1 Introduction	892
	6.2.2 Inapplicability of Quantum Mechanics for the Hadronic Structure	899
	6.2.3 Insufficiencies of Neutrino Conjectures	901
	6.2.4 Insufficiencies of Quark Conjectures	903
	6.2.5 Hadronic Two-Body Bound State	906
	6.2.6 The π^0 Meson as a Compressed Positronium	919
	6.2.7 Nonrelativistic Structure Model of the Neutron as a Hadronic Bound State of a Proton and an Electron	927
	6.2.7.A Foreword on the Need for New Clean Energies	927
	6.2.7.B Hadronic Realization of Rutherford's Conception	928
	6.2.7.C Representation of the Neutron Rest Energy, Meanlife and Charge Radius.	929
	6.2.7.D Representation of the Neutron Spin	931
	6.2.7.E Representatio of the Neutron Anomalous Magnetic Moment	934
	6.2.7.F Concluding Remarks	935
	6.2.8 Relativistic Structure Model of the Neutron as a Hadronic Bound State of a Proton and an Electron	938
	6.2.8.A Introduction	938
	6.2.8.B Poincaré-Santilli isosymmetry for the Neutron and its Isodual for the Antineutron	942
	6.2.8.C Santilli Isorelativity for the Neutron and its Isodual for the Antineutron	948
	6.2.8.D The Isoselfdual Dirac-Santilli Isoequation	949
	6.2.8.E Isospinorial Covering of the Poincaré-Santilli Isosymmetry and its Isodual	952
	6.2.8.F Isorenormalization of Spin and Angular Momentum	953
	6.2.8.G Isorenormalization of the Rest Energy	953

6.2.8.H	Isorenormalization of Electric and Magnetic Moments	955
6.2.8.I	Representation of the Neutron spin.	955
6.2.8.J	Representation of the Neutron Rest Energy.	956
6.2.8.K	Representation of the Neutron Magnetic Moment.	957
6.2.8.L	Representation of the Neutron Meanlife and Charge Radius	957
6.2.8.M	Dirac's Generalization of Dirac's Equation	959
6.2.8.N	Dirac-Santilli Genotopic and Hyperstructural Equations	963
6.2.8.O	The Meeting between Dirac and Santilli	964
6.2.9	The Etherino Hypothesis	966
6.2.10	The Etherino Hypothesis on the Neutron Synthesis	966
6.2.10.A	The Missing Energy in the Neutron Synthesis	966
6.2.10.B	Possible Origins of the Missing Energy in the Neutron Synthesis	966
6.2.10.C	The Etherino Hypothesis	969
6.2.10.D	Representation of the Etherino via Hadronic Mechanics	970
6.2.11	Neutron Decay: Possible New Longitudinal Communications?	970
6.2.11.A	Poincaré vs Poincaré-Santilli Symmetries	970
6.2.11.B	Alternatives in Neutron Decay	973
6.2.11.C	New Longitudinal Communications triggered by the Neutron?	974
6.2.12	Laboratory Synthesis of the Neutron from Protons and Electrons	976
6.2.12.A	The Dominant Factor in the Neutron Synthesis: Ethical Decay in Physics	976
6.2.12.B	Don Borghi's Experiment on the Neutron Synthesis	979
6.2.12.C	Santilli's Experiment "toward" the Neutron Synthesis.	981
6.2.12.D	Don Borghis Hypothesis of Neutroids	986
6.2.12.E	Again, Continuous Creation from the Synthesis of the Neutron?	992
6.2.12.F	Tentative Interpretation of Don Borghi and Santilli Experiments	995
6.2.12.G	Daddi's Studies on Don Borghi's Experiment	999

6.2.12.H	Has the Don Borghi Experiment Been Secretly Redone?	1008
6.2.12.I	How to Fake Don Borghi and/or Santilli Experiments	1009
6.2.13	Stimulated Decay of the Neutron	1011
6.2.13.A	The Dominant Factor in the Stimulated Decay of the Neutron: Ethical Decay in Physics	1011
6.2.13.B	The Main Hypothesis on the Neutron Stimulated Decay	1012
6.2.13.C	Proposed Tests for Stimulated Neutron Decays	1016
6.2.13.D	Classification of Hadronic Energies	1018
6.2.13.E	Examples of Hadronic Energies of Class I	1019
6.2.14	Tsagas experiment on the Stimulated Neutron Decay	1024
6.2.15	Santilli Experiment on the Stimulated Neutron Decay	1025
6.2.16	Application to the Stimulated Decay of Radioactive Nuclear Waste	1027
6.2.17	Hadronic Structure Model of Baryons with Physical Constituents	1029
6.2.18	Compatibility of the Hadronic Structure Models with SU(3)-Color Classifications	1030
6.2.19	Hadronic Structure Model of Mesons with Physical Constituents	1030
6.2.20	Hadronic Structure Model of Baryons with Physical Constituents	1030
6.2.21	Compatibility of the Hadronic Structure Models with SU(3)-Color Classifications	1030
6.3	EXPERIMENTAL VERIFICATIONS AND APPLICATIONS IN NUCLEAR PHYSICS	1030
6.3.1	Introduction	1030
	Appendices	1032
6.A	Ethical Problems in Particle Experiments	1032
6.B	Ethical Problems in String Theories	1040
6.C	Ethical Problems in Black Holes	1041
6.D	Requested Experiments	1042
	References	1053
7.	ISO-, GENO-, AND HYPER-GRAND-UNIFICATIONS AND ISO-, GENO-, HYPER-COSMOLOGIES	1059
7.1	ISO-, GENO-, AND HYPER-GRAND-UNIFICATION	1059

7.1.1	The Role of Antimatter in Grand Unifications	1059
7.1.2	Axiomatic Incompatibilities of General Relativity and Electroweak Interactions	1060
7.1.3	Resolution of the Incompatibilities via Isotopies and Isodualities	1062
7.1.4	Isotopic Gauge Theories	1069
7.1.5	Iso-, Geno- and Hyper-Grand-Unifications	1075
7.2	ISO-, GENO-, AND HYPER-SELF-DUAL COSMOLOGIES	1078
7.3	CONCLUDING REMARKS	1083
	References	1088
	Postscript	1090
	Index	1105

Foreword

These days, science is playing an ever increasing role in the lives of each and every one of us. The public is being lectured on climate change by very authoritative sounding people; the problems of the energy requirements of the world as a whole are being discussed quite openly and widely; more and more scientific topics are being discussed openly by people in positions of authority. What is not emphasised, in fact is rarely mentioned, however, is that at the centre of all these various discussions is physics. In the world of science, physics plays a crucial, all-pervading role. If science is viewed as a bicycle wheel, physics forms the hub at the centre; all the other branches of science act as the spokes of the wheel leading outwards from this central hub. In this context, mathematics is the language of physics and must always be subservient to the physics. Chemistry is merely one branch of physics; engineering may be viewed as the practical manifestation of physical principles; physics is seen by all to be playing a bigger and bigger role in medicine; in biology even, physics is becoming important particularly through the influence of thermodynamic principles, including that of entropy, in the examination of the theory of evolution. Hence, it is certainly not unreasonable to claim an all-pervading influence of physics in science. It must always be remembered, but frequently isn't, that physics is concerned with describing, and gaining an understanding of, the world around us. It follows that any models devised by man to achieve this are only as good as their ability to achieve this goal. Man's models will always be approximate and, therefore, always flawed. It is this which spurred Ruggero Santilli to attempt to extend the theory behind quantum mechanics and relativity when he realised that neither was, in fact, complete as a theory.

The first volume of this two volume set was devoted to the mathematical theory developed by Ruggero Santilli over a period of years in an attempt to make headway with the enormous task he had set for himself, for he had always realised that, to make any progress at all, some new mathematics would need to be developed. Mathematics as a tool of physics will always have a potential to restrict progress in physics since it is a purely manmade tool. Also, if one looks back through history to the likes of Newton and Einstein, it is apparent that each developed or introduced new mathematics in order to proceed with prodigious advances in physics. The mathematics introduced in the first volume might reasonably be considered a separate piece of work to be considered and appreciated in its own right. However, its purpose had always been to provide

a new tool to help us all in our quest to describe our universe and all that it contains. This means making the mathematics subservient to the physics; relegating the mathematics however beautiful it may be in its own right to a place on a spoke of that wheel of science referred to above. Once it takes on this role, any results obtained theoretically are only as good as their ability to accurately portray physical phenomena. In this second volume, the link up of theory with experimental results and observation is presented. It is for the general scientific community and any other readers of this work to adjudicate on its success or failure but this judgement, which could be so crucial to us all, must be made with open minds.

The areas in which this new work may be applied are varied. At the present time, possibly the most important application might seem to be the prediction of new clean energies. This could help solve the problems of energy supply and atmospheric pollution if the predictions prove correct. Already, however, a new clean energy, magnegas, has been produced and tested independently. This fact alone must lend credence to the theory presented and should surely provide an impetus to moves to examine the other predictions in great detail on a much wider scale. This is especially important since, on the basis of our present scientific knowledge, the only realistic method of fulfilling the worlds energy needs in the not-too-distant future is via nuclear power. As well as offering possible alternatives, the new theory also offers a possible means of dealing with nuclear waste safely. This, one would have thought, would have been something governments throughout the world would have wanted to investigate as a matter of urgency. It is to be hoped that the publication of this book will refocus attention on this vitally important topic and produce the necessary reaction from around the world.

However, the new theory is not restricted in its application to matters of energy resources. For example, it also offers alternative explanations for problems in astrophysics and cosmology. One fascinating aspect of these two areas of intense scientific endeavour is that, although many observations are made, both are subject to theoretical speculation which can never be completely verified or totally disproved because the time scales involved are far too long; for example, no-one lives anywhere near long enough to truly know the full facts concerning the birth, life and death of any star the theory in that case may be beautiful, it may appear to be a reasonable explanation of all we see, but one can never be certain it is absolutely correct. This is another area where open minds are essential. However, Halton Arps observations relating to quasars caused great consternation among conventionally thinking astronomers to the extent that he has become largely ostracised by the astronomical community. It is interesting that Ruggero Santillis work leads to a possible explanation for Arps findings which should not offend those conventional astronomers too much if they view

the ideas with open minds. Again, the same body of work offers an important contribution to the debate surrounding the existence of dark matter and dark energy. This life's work truly makes contributions to thought in diverse areas of human endeavour and should be examined far more widely than it is.

It is often said that behind every great man there is a great woman. This is true of Ruggero Santilli. It is for history, not me, to label anyone great or not but it is undoubtedly true that he has benefitted from the unswerving support and encouragement of his wife Carla. It is doubtful he would have achieved so much without this seemingly unquestioning devotion. As I wrote earlier, all Ruggero Santilli's scientific achievements may be seen to be the result of tremendous teamwork; a team comprising Ruggero himself and Carla Gandiglio in Santilli.

When anyone reaches the end of these two volumes then, and only then, will they be in a position to reflect on the work as a whole and think about coming to a conclusion. As stated previously, the theoretical framework is elegant but it is here to be judged on the basis of its use in physics, since that was the reason for its genesis. View the experimental and observational evidence, as well as the basic theoretical background, with open minds before coming to any final decision. Many, probably the majority, will then regard these two volumes as representing a truly monumental piece of work which deserves dissemination to a much wider circle of people—scientists, politicians, the business community, and, most of all, the general populace which ultimately pays for all scientific work, whether successful or not! The general public needs to be aware of all that is on the table for consideration, not simply those little tidbits which are released for ulterior motives.

Jeremy Dunning-Davies,
Physics Department,
University of Hull,
England.
October 8, 2007

Preface

In Volume I, we have identified the limitations of Einstein relativities and quantum mechanics; in Volume II, we have presented their resolution for antimatter; and in Volume III we have presented a sequence of covering theories for the study of matter and antimatter in conditions of progressively increasing complexity.

The main scope of this Volume IV is the presentation of experimental verifications, theoretical advances and industrial applications in particle physics, nuclear physics, astrophysics and cosmology, with particular reference to the search for new clean energies so much needed by mankind.

In preceding volumes we have initiated the denunciation of disruptions caused by organized academic, financial and ethnic interests on Einsteinian doctrines against their broadening. The understanding of this volume requires the awareness that these organized ascientific interests reach the climax of their misconduct in opposing, disrupting or jeopardizing experiments showing deviations from Einsteinian doctrines.

Such a claim has no credibility for scientists who did not conduct research beyond Einstein and, therefore, did not experience the disruption of their academic and family life by said organized interests, as it was the case for the author and so many other scientists around the world. Hence, it is necessary in this volume to initiate a documentation of what is internationally called nowadays "organized scientific crime," which documentation is presented in the footnotes of this and of the following volume.

In this way, the reader in good faith can see that the most fundamental is an experiment, the bigger the organized opposition against its conduction and that, when experimental measurements showing deviations from Einsteinian doctrines manage to escape the controlling grip by said organized interests, manipulated counter-experiments are often commissioned to reimpose the validity of Einsteinian doctrines via the abuse of academic credibility and public funds.

Since there is so much at stake for mankind, we ask the readers in good faith to defer judgment following the inspection of both, the scientific evidence and the documentation of scientific corruption. Whatever the reality, no reader with a minimum of dignity, let alone serious commitment to human knowledge, can deny that:

- 1) All experiments currently conducted in physics laboratories around the world are fully aligned with Einsteinian doctrines;

2) The conduction of fundamental experiments that might invalidate Einsteinian doctrines is systematically rejected at physics laboratories around the world in favor of dramatically less significant and immensely more expensive experiments strictly aligned with Einsteinian doctrines; and

3) Experiment establishing deviations from Einsteinian doctrines are discredited via the abuse of academic power rather than in the sole credible scientific way, the rerun of the measurements under an external ethical control.

To prevent becoming an accomplice, the reader in good faith should never forget that the resolution of the increasingly cataclysmic climactic changes in our planet can only be achieved via the surpassing of Einsteinian doctrines (see Volume I). Hence, in the event truly in good faith and truly committed to human dignity and scientific knowledge, the reader is expected to agree that the denunciations of scientific misconducts documented in this volume constitute a true crime against mankind.

Ruggero Maria Santilli

January 9, 2008

Legal Notice

The underwriter Ruggero Maria Santilli states the following:

1) To be the sole person responsible for the content of *Hadronic Mathematics, Mechanics and Chemistry*, Volumes I and II; to be the sole owner of the Copyrights on these two volumes; and to have recorded, beginning with 1992, the copyright ownership of a number of his main contributions in the field.

2) The undersigned hereby authorizes anybody to copy, and/or use, and/or study, and/or criticize and /or develop, and/or apply any desired part of these volumes without any advance authorization by the Copyrights owner under the sole condition of implementing known rules of scientific ethics, namely: 2A) The originating papers are clearly quoted in the initial parts; 2B) Scientific paternity are clearly identified and documented; and 2C) Any desired additional papers are additionally quoted at will, provided that they are directly relevant and quoted in chronological order. Violators of these known ethical rules will be notified with a request of immediate corrections essentially consisting publishing missed basic references. In the event of delays or undocumented excuses, authors who violate the above standard rules of scientific ethics will be prosecuted in the U. S. Federal Court jointly with their affiliations and funding sources.

3) There are insisting rumors that organized interests in science are waiting or the author's death to initiate premeditated and organized actions for paternity fraud via the known scheme, often used in the past, based on new papers in the field without the identification of the author's paternity, which papers are then quickly quoted as originating papers by pre-set accomplices and the fraud is then accepted by often naive or ignorant followers merely blinded by the academic credibility of the schemers. Members of these rumored rings should be aware that the industrial applications of hadronic mathematics, mechanics and chemistry have already provided sufficient wealth to set up a Paternity Protection Trust solely funded to file lawsuits against immoral academicians attempting paternity fraud, their affiliations and their funding agencies.

This legal notice has been made necessary because, as shown in Section 1.5, the author has been dubbed "the most plagiarized scientist of the 20-th century," as it is the case of the thousands of papers in deformations published without any quotation of their origination by the author in 1967. These, and other attempted paternity frauds, have forced the author to initiate legal action reported in web site [1].

In summary, honest scientists are encouraged to copy, and/or study, and/or criticize, and/or develop, and/or apply the formulations presented in these volumes in any way desired without any need of advance authorization by the copyrights owner, under the sole conditions of implementing standard ethical rules 2A, 2B, 2C. Dishonest academicians, paternity fraud dreamers, and other schemers are warned that legal actions to enforce scientific ethics are already under way [1], and will be continued after the author's death.

In faith

Ruggero Maria Santilli

U. S. Citizen acting under the protection of the First Amendment of the U. S. Constitution guaranteeing freedom of expression particularly when used to contain asocial misconducts.

Tarpon Springs, Florida, U. S. A.

October 11, 2007

[1] International Committee on Scientific Ethics and Accountability
<http://www.scientificethics.org>

Acknowledgments

The author expresses his deepest appreciation in memory of:

- The late Werner Heisenberg, for supporting in epistolary exchanges studies a nonlinear generalization of his celebrated equation (today known as Heisenberg-Santilli isotopic, genotopic and hyperstructural equations at the foundations of hadronic mechanics), with particular reference to their treatment via a new mathematics capable of reconstructing linearity on generalized spaces over generalized fields, since Heisenberg dedicated his last years to the evident nonlinear character of nature;

- The late Paul A. M. Dirac, for supporting in a short but memorable meeting reviewed in Section 6.2.8, nonunitary liftings of his celebrated equation (today known as Dirac-Santilli isotopic, genotopic and hyperstructural equations) for the representation of an electron within the hyperdense medium inside the proton, with particular reference to the development of a new mathematics eliminating the vexing divergencies in particle physics, since Dirac spent his last years in attempting the elimination of divergencies amidst strong opposition by organized interests on quantum chromodynamical theologies;

- The late British philosopher Karl Popper, for his strong support in the construction of hadronic mechanics, as shown in the Preface of his last book *Quantum Theory and the Schism in Physics*;

- The late Ilya Prigogine, for pioneering the need of nonunitary broadening of quantum mechanics and statistics and his personal support for the organization of the *Hadronic Journal* since its inception;

- The late Italian physicist Piero Caldirola, for his pioneering work in non-canonical broadening of conventional theories, for initiating new notions of time as well as for support for the construction of hadronic mechanics;

- The Greek mathematician Grigorios Tsagas, for fundamental contributions in the Lie-Santilli isothory underlying hadronic mechanics;

- The late Italian physicist Giuliano Preparata, for pioneering anisotropic departures from the geometric structure of special relativity, extended by hadronic mechanics into anisotropic and inhomogeneous media;

- The late American mathematician Robert Oehmke for pioneering work on the Lie-admissible structure of hadronic mechanics;

- The late Estonian mathematician Jaak Lõhmus whose studies on nonassociative algebras, with particular reference to the octonion algebra, have been particularly inspiring for the construction of hadronic mechanics;

- and other scholars who will be remembered by the author until the end of his life.

The author expresses his appreciation for invaluable comments to all participants of: the *International Workshop on Antimatter Gravity and Anti-Hydrogen Atom Spectroscopy* held in Sepino, Molise, Italy, in May 1996; the *Conference of the International Association for Relativistic Dynamics*, held in Washington, D.C., in June 2002; the *International Congress of Mathematicians*, held in Hong Kong, in August 2002; the *International Conference on Physical Interpretation of Relativity Theories*, held in London, September 2002, and 2004; and the *XVIII Workshop on Hadronic Mechanics* held in Karlstad, Sweden, in June 2005.

The author would like also to express his deepest appreciation to Professors: A. van der Merwe, Editor of *Foundations of Physics*; P. Vetro, Editor of *Rendiconti Circolo Matematico Palermo*; G. Langouche and H. de Waard, Editors of *Hyperfine Interactions*; V. A. Gribkov, Editor of *Journal of Moscow Physical Society*; B. Brosowski, Editor of *Mathematical Methods in Applied Sciences*; D. V. Ahluwalia, Editor of the *International Journal of Modern Physics*; T. N. Veziroglu, Editor of the *International Journal of Hydrogen Energy*; H. Feshback, Editor of the (MIT) *Annals of Physics*; the Editors of the Italian, American, British, French, Russian, Indian and other physical and mathematical societies; and other Editors for very accurate refereeing in the publication of papers that have a fundamental character for the studies presented in these monographs.

Particular thanks are also due for invaluable and inspiring, constructive and critical remarks, to Professors A. K. Aringazin, P. Bandyopadhyay, P. A. Bjorkum, L. Daddi, J. Dunning-Davies, T. L. Gill, E. J. T. Goldman, I. Guendelman, F. W. Hehl, M. Holzscheiter, L. Horwitz, S. Kalla, J. V. Kadeisvili, N. Kamiya, A. U. Klimyk, S. Johansen, D. F. Lopez, U. mastromatteo, J. P. Mills, jr., R. Miron, P. Rowlands, G. Sardanashvily, K. P. Shum, H. M. Srivastava, N. Tsagas, E. Trel, V. Valenzi, C. Udriste, C. Whitney, F. Winterberg, and others.

Special thanks are finally due to Professors D. V. Ahluwalia for an invaluable critical reading of an earlier version of the manuscript and for suggesting the addition of isodual space and time inversions. Additional thanks are due to Professors J. Dunning-Davies, V. Keratohelcoses and H. E. Wilhelm for an accurate reading of a later version of the manuscript.

Thanks are finally due to Prof. Richard Koch of the University of Oregon for assistance in composing this monograph with TexShop, and to Dr. I. S. Gandzha for assistance in the LaTeX composition, without which help these volumes would not have been printed. Thanks are finally due to various colleagues for a technical control, including Drs. G. Mileto, M. Sacerdoti and others, and to Mrs. Dorte Zuckerman for proofreading assistance. Needless to say, the author is solely responsible for the content of this monograph due also to several additions and improvements in the final version.

Chapter 6

EXPERIMENTAL VERIFICATIONS AND APPLICATIONS IN PARTICLE PHYSICS, ASTROPHYSICS AND COSMOLOGY

6.1 EXPERIMENTAL VERIFICATIONS IN CLASSICAL AND PARTICLE PHYSICS

Foreword

No appraisal of the numerous experimental verifications of hadronic mechanics in all quantitative sciences can be seriously conducted without the joint addressing of the collapse of scientific ethics in the contemporary physics community due to protracted impunity caused by the studious absence of any control at any levels.

Due to this deplorable condition, the preceding version of this volume presented the experimental evidence in the main text and documentation of ethical misconducts in the footnotes, so as to provide readers with the necessary elements to unmask biased dismissals of experimental evidence for personal gains.

All footnotes on the documentation of scientific misconducts have been removed from the present version of this volume, and have been transferred to the Santilli Foundation for their editing in the proper language and uploading in the web site <http://www.santilli-foundation.org>. No appraisal of the content of this and of the following volume can be serious without a knowledge of the documentation of ethical misconducts at all levels of the physics community presented in the indicated Foundation.

6.1.1 Introduction

As stated in Volume I, we assume the exact validity of *special relativity*, and *quantum mechanics* for all possible *exterior dynamical problem* as conceived at the beginning of the 20-th century (and thereafter ignored), namely, physical conditions permitting the point-like abstraction of particles, and generally given by particles at large mutual distances and electromagnetic waves propagating in

vacuum hereinafter referred to a universal substratum underlying all events in the universe visible to mankind.

Typical cases of exterior dynamical problems are the propagation of light in vacuum, the structure of the hydrogen atom, particles in particle accelerators, the structure of crystals, and various other systems for which conventional theories are assumed to be exactly valid.

In this chapter, we present a number of experimental evidence in various fields establishing the exact validity of the covering *isorelativity* and *hadronic mechanics* for the more general *interior dynamical problems* as also conceived at the beginning of the 20-th century (and thereafter regrettably ignored), and generally given by physical conditions under which the point-like abstraction of particles is excessively approximate, thus requiring a representation of their actual size.

Interior dynamical problems generally occur for mutual distances of particles of the order of the size of their charge distributions and/or wavepackets, dynamics within physioal media, and other problems such as: the propagation of light within transparent physical media; dynamics of particles within physical media opaque to light, thus lacking the central pillar of special relativity, the propagation of light; strong interactions at large, including the structure of hadrons, nuclei and stars; deep inelastic scatterings of hadrons; and other cases of extended, generally nonspherical and deformable particles at mutual distances of the order of $1 \text{ fm} = 10^{-13} \text{ cm}$ or less, in which case we have the partial or total mutual penetration of the wavepackets and/or the charge distributions of particles.

In Volume I, we have established the impossibility for special relativity and quantum mechanics to be exactly valid for interior conditions due to numerous evidence, such as: the absence of a Keplerian structure in the interior of hadrons, nuclei and stars, with consequential impossibility for the Poincaré symmetry being exact; the emergence of nonlinear, nonlocal and nonpotential interactions that are dramatically beyond any possible representation by a Hamiltonian, let alone incompatible with the underlying conventional topology and related mathematics at large; and other evidence.

In reading this chapter, a clear understanding is that the *approximate* validity of special relativity and quantum mechanics for interior dynamical conditions remains beyond scientific doubt. However, as we shall see, the exact representation achieved by the covering isorelativity and hadronic mechanics have far reaching implications, such as: the lack of necessary existence in our spacetime of quarks, neutrinos, dark matter and other conjectures formulated to salvage orthodox doctrines; the conception and industrial development of much needed new clean energies and fuels simply inconceivable with conventional doctrines; and other much needed theoretical, experimental and industrial advances.

Hence, the search for suitable structural generalizations (rather than marginal touches) of special relativity and quantum mechanics is presented in these vol-

umes as a *collegial duty of the mathematical, physical and chemical communities mandated by scientific ethics and accountability in view of the huge societal implications, e.g., for the solutio of the increasingly alarming environmental problems.* Due to the evident complexity of the problems herein addressed, any rejection based on lack of total and absolute maturity *without the joint proposal of better structural generalizations of Einsteinian doctrines and quantum mechanics,* will be considered sheer scientific corruption because, whether studious or de facto, opposes for personal gains advances so much needed by mankind whose final achievement will predictably require the laborious historical process of trial and error, presentation of advances in the only scientifically meaning way, via publications, and their improvement also in the only scientifically possible way, via publications.

6.1.2 Space, the Final Frontier of Knowledge

As it is well known, we would not be able to hear each other's voices without Earth's atmosphere, because sound is a wave that, as such, requires a medium for its existence and propagation. In particular, sound is a *longitudinal wave*, namely, a wave whose oscillations occur in the direction of propagation, thus requiring a compressible medium, as it is the case for our gaseous atmosphere.

Similarly, we would not be able to see each other's faces without the *ether* (also called *aether*, or *space*, or *universal substratum*, or *vacuum*) conceived as a universal medium because light is also a wave, thus equally requiring a medium for its existence and propagation. In particular, light is a *transversal wave*, namely, a wave whose oscillations occur in the direction perpendicular to that of propagation, thus requiring a medium with characteristics similar to very high rigidity due to the very big value of the speed of light.¹

The elimination of the universal substratum in the physics of the 20-th century is an excellent topic for investigation by ethically sound historians, because it is a clear illustration of how physical evidence is manipulated to fit preferred theories, and how widely manipulations are accepted because science advances by perceived credibility and/or of academic favors, and not solely because on intrinsic scientific truth.

About fifty years ago, the author decided to dedicate his life to "scientific research" intended as the unobstructed, quantitative pursue of new scientific knowledge. As such, the author never did and never will adapt evidence to preferred theories, but always did and always will adapt theories to physical reality.

¹Contrary to a number of popular views, the transversal character of light excludes the possibility that space is compressible or that it has characteristics similar to that of a liquid. To separate science from philosophical considerations, it should be stressed that no theory on space as a universal medium can be considered scientific unless it permits a quantitative representation of the *transversal* character of light, due to its evident fundamental character.

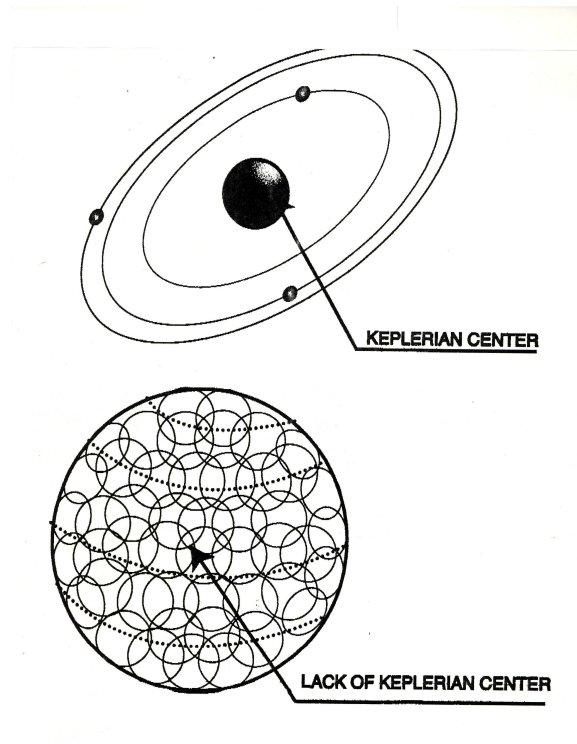

Figure 6.1. A schematic view of one of several impossibilities for special relativity and quantum mechanics as being exactly valid for interior dynamical problems. The figure depicts the general lack of a Keplerian structure as well as of a Keplerian center in the transition from a planetary system to the structure of one of its planets, such as Jupiter, with consequential impossibility for the central pillar of special relativity, the Poincaré symmetry, as being exact. When considering operator interior problems such as the structure of hadrons, nuclei and stars, besides the loss of the Keplerian structure, we have the additional impossibility of identifying clearly quantized orbits, thus losing the very notion of a quantum in favor of covering vistas. The theoretical studies conducted over three decades, presented in detail in EHM-I, EHM-II, Volume I and briefly summarized in this chapter, have achieved a covering of the mathematical and physical foundations of special relativity and quantum mechanics permitting an invariant formulation of interior dynamical systems without Keplerian structure and Keplerian center. This volume is dedicated to their experimental verification, theoretical advance, and industrial applications.

Einstein special relativity does not admit an absolute frame of reference, as well known. As equally well known, a universal substratum is perceived as requiring an absolute frame of reference. Consequently, the physics of the 20-th century decided that the universal substratum does not exist because not permitted by Einsteinian doctrines.

The "arguments" used to eliminate the universal substratum should be, per se, reason for investigation by ethically sound historians, because a vivid illustration

on how physics, a discipline intended as being quantitative and objective, is turned into political dogmas.

By leaving details to historians, a first argument for the elimination of the universal substratum was the reduction of light to photons that, as such, propagate like particles, thus not requiring any medium for their existence and propagation. The political character of this "argument," particularly when proffered by experts, is soon unmasked because radio waves with, say, one meter in wavelength, cannot possibly be reduced to photons in any credible way. Yet, the reduction of all electromagnetic waves to photons for the purpose of maintaining the validity of Einsteinian doctrines, was widely accepted during the 20-th century because only its serious scrutiny would cause instant "disqualifications" and claims of "fringe science" by organized interests on Einsteinian doctrines.

Another argument used for adapting nature to preferred theories was the so-called *aethereal (or ethereal) wind*, namely, the evidence that Earth encounters no "wind" (that is, no resistance) during its motion through space. Therefore, the universal substratum does not exist, according to this "argument."

The first paper written by the Santilli back in 1956 [1] (when a high school student), was intended to eliminate the aethereal wind and stress the need, not only for a universal medium for the existence and motion of matter, but also for a medium with features similar to high rigidity and extreme energy density (See Ref. [2] for historical accounts).

As it is well known, the electron is a "pure" oscillation with the well known frequency of 1.236×10^{20} Hz, namely, without any oscillating "little mass" or other "little material entity," as proved by Schrödinger in 1935 as being the case for the variable x in Dirac's equation for the electron. This evidence mandates the need for a universal medium because in the structure of the electron, we merely have the *oscillation of a dimensionless point of the universal substratum*.

Ref. [1] indicated that, when the electron moves, it "cannot" experience any "aethereal wind" because we merely move its characteristic oscillation from one point of the aether to others. Ref. [54] then suggested that the inertia (from which we compute the mass) is in actuality a tendency of the aether to oppose variations in the propagation of said oscillations.

Paper [1] then suggested that the same occurrence holds for all other elementary and, thus, composite particles. Consequently, the aether as a universal medium is necessary not only for the existence and propagation of electromagnetic waves, but also for the very existence and propagation of all elementary and composite particles and, therefore, of matter as perceived by our senses.

The main conclusion of paper [1] is that, *contrary to our sensory perception, matter is "entirely empty" and space is "entirely full,"* because matter and electromagnetic waves can be entirely reduced to pure oscillations of the aether. To be more specific in this important point, it is generally believed that matter

is "mostly empty," in the sense that, for any material substance, interatomic distances are large and then the distances between electrons and nuclei are proportionately equivalent to planetary distances. The terms "entirely empty" are referred to the fact that, following the reduction of matter to electrons, protons and neutrons, these particles too result to be empty, that is, lacking any material entity, because they are "pure oscillations" of space, that is oscillations of its point without any oscillating material entity.

When initiating his academic life in the late 1960s, the author soon discovered that any mention of the aether as a universal medium would imply instant disqualification and loss of academic jobs due to organized academic interests on Einsteinian doctrines in control of the world wide physics community. Consequently, the author had to abandon his studies of the aether and dedicate himself to other studies.

Nevertheless, *physical veritas* is not established by academic power, but by evidence. No matter how beloved and supported a given theory may be at a given time, no relativity can resist the test of time without a serious addressing of the existence of the universal substratum and its universal reference frame.

In this volume, *we assume that space is a universal medium characterized by the superposition of extremely high equal densities of positive and negative energies* that, according to the isodual theory of antimatter, can coexist because defined in physically different spaces: the conventional space over conventional numbers (with positive unit) for positive energies, and the isodual space on isodual numbers (with negative units) for negative energies (see Chapters 2 and 3 for details on the isodual theory).

It should be indicated that, when studying later on the hyperstructural branch of hadronic mechanics, the existence of matter and antimatter in separate, yet coexisting spaces is only the first example of our hyperstructures. Note that in the physics of the 20-th century, matter and antimatter were conceived as existing in the same space, but this led to a large scientific imbalance, that matter could be treated at all levels while antimatter could be treated only at the level of second quantization. This imbalance was solved by the isodual theory of antimatter with resulting first hyperstructural character of matter and antimatter, that will be later on expanded for cosmological and other aspects.

In regard to the historical problem of compatibility of any given relativity with space conceived as a universal medium, we assume the pragmatic position that *no material system known to date can possibly identify the absolute reference frame at rest with respect to the universal medium. Hence, all issues pertaining to compatibility with the absolute reference frame are deferred to epistemological studies not contemplated in this volume.*

6.1.3 The Far Reaching Implications of Space as a Universal Medium

Far from claiming final knowledge one way or the other, the position assumed in these volumes is that *the existence of space (or ether) as a universal substratum for all events occurring in the universe is supported by sufficient evidence as being plausible, hence warranting its systematic study, because of implications simply beyond our imagination at this time*, such as:

1) As studied in detail in Section 6.2, the rest energy of the neutron is 0.78 MeV bigger than the sum of the rest energies of the proton and of the electron. As a result, the synthesis of the neutron inside stars, $p^+ + e^- \rightarrow n + \nu$, requires a minimum of 0.78 MeV (in which case there is no energy left for the neutrino). Evidently, this "missing energy" can be provided by the environment inside a star. However, due to the extreme density in the core of a star, the proton and the electron are expected to be at rest during said synthesis. It is then possible that the "missing energy" of 0.78 MeV originates from space as a universal medium with high energy density. Alternatively, the old hypothesis of continuous creation of matter in the universe could see its realization in the synthesis of the neutron inside stars, with far reaching implications. At any rate, due to the extremely high number of neutron syntheses occurring in a star every second, each one *requiring* 0.78 MeV energy, the idea of a star with *decreasing* energy is unappealing, thus mandating alternative studies. In the event the neutron is indeed a mechanism set by nature to extract energy from the ether, the possibilities for mankind are simply beyond imagination. Hence, the understanding of these volumes requires the knowledge that *hadronic mechanics is the first and only known theory permitting quantitative and invariant studies of the possible interplay between matter and the universal substratum*.

2) As we shall see, quantum mechanics is inapplicable for the neutron synthesis $p^+ + e^- \rightarrow n + \nu$ because the Schrödinger equation fails to provide physical solutions for "positive binding energies.". The non-expert reader is encouraged to verify this occurrence by attempting to solve any quantum bound state in which the usual "negative" potential is turned into a "positive" value. In fact, all physically consistent, quantum bound states (such as nuclei, atoms and molecules) have a "negative" binding energy. Hadronic mechanics was proposed by the author in memoir [14] of 1978 precisely for the achievement of a quantitative representation of the synthesis of the neutron inside stars from protons and electrons. This objective was achieved in its entirety with the numerically exact and time invariant representation of *all* characteristics of the neutron as a hadronic bound state of a proton and an electron, without any need of hypothetical quarks. In turn, the restricted of quarks as they are technically defined (purely mathematical quantities outside our spacetime for the elaboration of unitary symmetries), and the replacement of hadrons with physical constituents that can be produced free, cre-

ate far reaching possibilities for basically new *hadronic energies*, namely, energies originating from mechanisms in the interior of individual hadrons, rather than their collection. At any rate, the current quark theories and related Quantum ChromoDynamics (QCD) imply that the proton and the electron simply "disappear" at the time of the neutron synthesis to please organized interests in the field and, then, the proton and the electron "reappear" at the time of the neutron decay. These theories have always been repugnant for Santilli, and they will always remain so, because pushing what is expected to be serious science immensely beyond any level of credibility, while opposing, disrupting and jeopardizing dissident view for personal gains.

3) When compared to interstellar distances, contemporary communications via electromagnetic waves can be compared to the communications with smoke signals during prehistoric times, evidently due to interstellar distances rendering the speed of light excessively small. Hence, serious studies on future interstellar communications require the search for *new* communications with a speed dramatically bigger than that of light, among which, the first possibility is the conception, quantitative treatment, and subsequent realization of *longitudinal waves propagating through the ether as a universal medium*. In fact, due to the very high rigidity of the universal substratum requested to represent the speed of transversal waves, longitudinal waves are predicted to propagate in space with speeds millions of times bigger than the speed of light. As well known, longitudinal waves are not predicted by Einstein special relativity (because not admitted by Maxwell's electrodynamics). However, the dismissal of the possible existence of longitudinal waves in space just because not predicted by Einsteinian doctrine is purely political and such a dismissal should itself be dismissed because non-scientific. Intriguingly, this possibility of fundamentally new form of longitudinal communications occurs if and only if neutrinos do not exist as physical particles in our spacetime, and their current "detection" is replaced precisely by longitudinal impulses. More specifically, the alternative hypothesis, called *etherino* by Santilli is that, at the time of its decay, rather than emitting a hypothetical neutrino, the neutron creates a longitudinal impulse through the ether (see Section 6.2 for details) that is currently interpreted as a particle in current experiments. The resolution of this possibility will evidently require centuries. At this point we merely indicate that the replacement of neutrinos as hypothetical physical particles with longitudinal impulses propagating through spaces without any propagation of ordinary mass or energy, eliminate the current theory requested by QCD that *neutrino, nowadays assumed to have mass, can propagate throughout entire stars and galaxies without any collision at all!* This theory has always been repugnant to Santilli and it will always remain so because, again, turning supposedly serious science dramatically beyond any level of plausibility for personal gains.

4) As indicated above, space is emerging as possessing an energy density beyond our imagination, to the extent that one cubic centimeter of space may contain more energy than that of the entire Sun. The isodual theory has established that negative energy exist in a spacetime different, yet coexisting, with that of positive energies. Hence, the isodual theory implies that space may be characterized by a a superposition of extreme equal values of positive and negative energies, with far reaching implications, such as the elimination of discontinuities at creation of the universe, the elimination of the very meaning of the search of the "age of the universe",² and other implications.

5) In the 20-th century, famous scientists claimed that it would be impossible for mankind to go to the moon and return safely. Scientific and technological advances proved them wrong. Nowadays, other scientists are on record with the claim that mankind will never travel to far away stars, and return safely to Earth, due to extreme distances. The claim is based, again, on the tacit assumption of the universal validity of Einsteinian doctrines and it is "justified" not only on ground of the time required for such a travel, but also for the need of a fuel tank as big as the entire solar system. When passing to serious science, Einstein doctrines must be assumed to have their own limitations, in which case a number of possibilities emerge as conceivable already at the current primitive stage of our scientific evolution. After all, the science fiction of a given time has been surpassed by subsequent scientific advances. With the clear understanding that serious scientific studies on interstellar travel may well require the entire third millennium, the possible existence of space as a universal medium of the above type resolves, at this time on purely *mathematical* grounds, all the above objections. In fact, the above conception of space as a universal medium of extremely high equal amount of positive and negative energies allows the *spacetime isogeometric locomotion* studied in Chapter 14 for which: a) there is no need for any "fuel tank" at all since the needed fuel could be extracted from space via mechanisms similar to that for the neutron synthesis or other yet unknown means; b) there is no limitation to speeds because the locomotion is not Newtonian, namely, without action and reaction, and occurs via a control of distances predicted by isogeometries to have unlimited speeds; and c) motion is necessarily in both space and time, since any deformation of the former requires that of the latter, and vice-versa.

It is hoped that, besides the desire of stimulating young minds of any age, the above comments illustrates a main viewpoint conveyed in these volumes: *rather than having reached final character as proffered by political interests on Einsteinian doctrines, studies on relativity laws are at their infancy, and so much remains yet to be discovered.*

²Because the "total age" of mater and (isodual) antimatter is zero.

6.1.4 Rudiments of Santilli Isorelativity

For minimal self-sufficiency of this volume, let us recall that special relativity and relativistic quantum mechanics are based on the "universal constancy of the speed of light" c_o that is achieved via the invariance of the line element in the *Minkowskian spacetime* $M(x, \eta, R)$ (Section I.3.5.3)

$$\begin{aligned} x^2 &= (x^\mu \times \eta_{\mu\nu} \times x^\nu) \times I = \\ &= (x^1 \times x^1 + x^2 \times x^2 + x^3 \times x^3 - x^4 \times x^4) \times I \in R, \\ x^4 &= c_o \times t, \quad I = \text{Diag.}(1, 1, 1, 1), \end{aligned} \quad (6.1.1)$$

under the celebrated *Lorentz symmetry* $O(3,1)$ characterized by the *Lorentz transformations* here expressed for simplicity in the $(3,4)$ coordinates

$$x^{1'} = x^1, \quad x^{2'} = x^2, \quad (6.1.2a)$$

$$x^{3'} = \gamma \times (x^3 - \beta \times x^4), \quad x^{4'} = \gamma \times (x^4 - \beta \times x^3), \quad (6.1.2b)$$

$$\gamma = (1 - \beta^2)^{-1/2}, \quad \beta = v^2/c_o^2, \quad (6.1.2c)$$

where: \times is the conventional associative product; $+$ is the conventional sum; $I = \text{Diag.}(1, 1, 1, 1)$ is the fundamental unit of the Lorentz symmetry $O(3,1)$; for consistency, I is assumed as the unit of the base field of real numbers $R = R(n, +, \times)$; and the multiplication of the line element by I is then necessary for x^2 to be an element of the assumed base field.

However, the "universal constancy of the speed of light" is a manipulation of scientific reality, particularly when ventured by experts, whenever said statement is proffered without the crucial addition "in vacuum." In fact, the "universal constancy of the speed of light in vacuum" (namely, in exterior conditions), has been experimentally established beyond scientific or otherwise useful doubt. When this statement is contracted into "universal constancy of the speed of light" it is referred to all possible conditions existing in the universe, including interior conditions. In the latter case, not only we have no experimental evidence at all, but have robust evidence on the lack of constancy of the speed of light. Hence, when experts venture the statement of the "universal constancy of the speed of light" without the crucial specification "in vacuum," they perpetrate a manipulation of science intended to extend the validity of special relativity to all possible conditions existing in the universe.

For all cases of interior dynamical problems within a physical medium, experimental evidence establishes that *the speed of light c is a local variable* depending on the density d , temperature τ , frequency ω , and other characteristics of the medium considered, $c = c(d, \tau, \omega, \dots)$, as expressed by the historical form studied in high school

$$c = c(d, \tau, \omega, \dots) = \frac{c_o}{n} = \frac{c_o}{n(d, \tau, \omega, \dots)}. \quad (6.1.3)$$

Organized interests on Einsteinian doctrines have attempted to dismiss the local character of the speed of light via the reduction of light to photons scattering among atoms, in which case photons propagate in vacuum, hence at the speed c_o . In Section I.1, we have shown the nonscientific character of this claim on various grounds, such as: the impossibility of reducing to photons electromagnetic waves with one meter wavelength; the inability of the reduction to photons for speeds bigger than c_o nowadays experimentally established beyond credible doubt (see Section 6.1.7); the collapse of the axioms of special relativity even for the simple case of propagation of light in water, due to either the violation of causality (because ordinary electrons can propagate in water at speeds bigger than the local speed $c = 2 \times c_o/3$) or the violation of the axiom of relativistic sums of speeds of light; and other evidence.

The only possible scientific statement is that *special relativity and, consequently, relativistic quantum mechanics, are inapplicable (rather than violated) for interior dynamical systems* because not conceived for them. To prevent exiting from the boundaries of science, the broader relativity and related mechanics can indeed be subjected to scientific debates, but not their need.

To the author's best knowledge, the first studies on the invariance of the locally varying character of the speed of light were conducted by Lorentz [3] in 1895 via Eq. (6.1.3). These studies were ignored throughout the 20-th century evidently because not aligned with organized interests on special relativity, although Lorentz studies [1] did not escape Pauli's attention who quoted them in a footnote of his book [93].

Unfortunately, Lorentz failed to achieve the invariance of $c = c_o/n(d, \tau, \omega, \dots)$ and was forced to study the simpler case $c = c_o = \text{constant}$ in which case he did achieve the historical symmetry transformations (6.1.2).

The author has dedicated his research life to Lorentz's legacy [3] via decades of laborious studies reported in Volume I (as well as in the preceding volumes EHM-I and II). In essence, it emerged already at the time of the author's graduate studies in physics of the late 1960s that *Lorentz failed to achieve the invariance of the locally varying speed of light because the mathematics he used, Lie's theory, was indeed effective for the case of $c = c_o = \text{constant}$, but basically insufficient for the broader case $c = c_o/n(d, \tau, \omega, \dots)$.*

Hence, the author dedicated his efforts, firstly, to a structural generalization (called *lifting*) of Lie's theory, today known as the *Lie-Santilli iso-, geno- and hyper theory* for closed single-valued, open single-valued, and open multi-valued conditions of matter and their *isoduals* for antimatter (see Volume I for a review and EHM-I and II for detailed studies).

In particular, the author discovered that invariance was achieved if and only if any structural generalization of Lie's theory was formulated via a compatible lifting of the *totality* of the underlying mathematics, including numbers, prod-

ucts, fields, spaces, topologies, functional analysis, differential calculus, etc. The resulting new formulations are today known as *Santilli iso-, geno-, and hyper-mathematics* for matter and their *isoduals* for antimatter.

As now familiar in the field, these broader mathematics are based on the lifting of the basic unit of Lorentz symmetry, $I = \text{Diag.}(1, 1, 1, 1)$, into the most general possible units $\hat{I}, \hat{I}^>, \hat{I}^{\{>\}}$, called *Santilli iso-, geno- and hyper-units*, respectively, with compatible lifting of the product and of the entire conventional mathematics.

By ignoring to avoid excessive complexities the open, irreversible, single-valued case (used for the invariance of light during its absorption) and the open, irreversible, multi-valued case (used for biological processes), we here briefly outline for self-sufficiency the main lines of the isotopic lifting of the Lorentz symmetry.

The transition from the Minkowski metric for the propagation of light in vacuum, $\eta = \text{Diag.}(1, 1, 1, -c_o^2)$, to the generalized Minkowski-Santilli isometric for the propagation of light within transparent physical media, $\hat{\eta} = \text{Diag.}(1, 1, 1, -c^2)$, $c = c_o/n$ is a necessarily *noncanonical transformation* at the classical level or a *nonunitary transformation* at the operator level,

$$\eta = (1, 1, 1, -c_o^2) \rightarrow \hat{\eta} = \text{Diag.}(1, 1, 1, -c^2/n^2) = Z \times \eta \times Z^\dagger, \quad (6.1.4a)$$

$$Z = \text{Diag}(1, 1, 1, i/n), \quad Z \times Z^\dagger \neq I. \quad (6.1.4b)$$

The use of rotations and Lorentz transforms then yields a lifting of all remaining components of the isometric. The Lie-Santilli isothory is constructed by applying, for reasons clarified below, the inverse of the metric transform to the totality of the mathematics underlying Lie's theory, resulting in expressions of the type

$$\begin{aligned} U \times U^\dagger &= (Z \times Z^\dagger)^{-1} = \text{Diag.}(1/b_1^2, 1/b_2^2, 1/b_3^2, 1/b_4^2), = \\ &= \text{Diag.}(n_1^2, n_2^2, n_3^2, n_4^2) \end{aligned} \quad (6.1.5a)$$

$$\begin{aligned} I \rightarrow \hat{I} &= U \times I \times U^\dagger = \text{Diag.}(1/b_1^2, 1/b_2^2, 1/b_3^2, 1/b_4^2) = \text{Diag.}(n_1^2, n_2^2, n_3^2, n_4^2), \\ n_\alpha &= n_\alpha(\mu, \tau, \omega, \dots), n_4 = n, \end{aligned} \quad (6.1.5b)$$

$$n \in R \rightarrow \hat{n} = U \times n \times U^\dagger = n \times (U \times U^\dagger) = n \times \hat{I} \in \hat{R}, \quad (6.1.5c)$$

$$n \times m \rightarrow \hat{n} \hat{\times} \hat{m} = U \times (n \times m) \times U^\dagger = \hat{n} \times \hat{T} \times \hat{m}, \quad \hat{T} = 1/U \times U^\dagger, \quad (6.1.5d)$$

$$[X_i, X_j] = X_i \times X_j - X_j \times X_i \rightarrow [\hat{X}_i, \hat{X}_j] = \hat{X}_i \hat{\times} \hat{X}_j - \hat{X}_j \hat{\times} \hat{X}_i = U \times [X_i, X_j] \times U^\dagger, \quad (6.1.5e)$$

$$e^X \rightarrow \hat{e}^{\hat{X}} = U \times (e^X) \times U^\dagger = (e^{X \times \hat{T}}) \times \hat{I} = \hat{I} \times (e^{\hat{T} \times X}), \quad \text{etc.} \quad (6.1.5f)$$

The invariance under additional nonunitary transforms is assured, provided that it is studied within the context of *isomathematics* and not that of conventional mathematics. This requires the identical reformulation of a given nonunitary transform into the *isounitary transform*,

$$W \times W^\dagger \neq I, \quad W = \hat{W} \times \hat{T}^{1/2}, \quad W \times W^\dagger \equiv \hat{W} \hat{\times} \hat{W}^\dagger = \hat{W}^\dagger \times \hat{W} = \hat{I}, \quad (6.1.6)$$

under which we have the invariance laws

$$\hat{I} \rightarrow \hat{W} \hat{\times} \hat{I} \hat{\times} \hat{W}^\dagger \equiv \hat{I}, \quad (6.1.7a)$$

$$\hat{X}_i \hat{\times} \hat{X}_j \rightarrow \hat{W} \hat{\times} (\hat{X}_i \hat{\times} \hat{X}_j) \hat{\times} \hat{W}^\dagger = \hat{X}'_i \times \hat{T} \times \hat{X}'_j = \hat{X}'_i \hat{\times} \hat{X}'_j, \quad \text{etc.} \quad (6.1.7b)$$

from which all other invariances follow. Note the *invariance of the numerical value of the isounit \hat{I} and of the isoproduct represented by the numerical invariance of \hat{T}* .

The application of the above formalism to the invariance of locally varying speeds of light was achieved for the first time by R. M. Santilli in paper [4a] of 1983 at the classical level and in paper [4b] of the same year for the operator counterpart, to be studied in detail in subsequent papers [5] and additional ones. These studies achieved the invariance of the following universal *isoline isoelement* on the *Minkowski-Santilli isospace* $\hat{M}(\hat{x}, \hat{\eta}, \hat{R})$

$$\begin{aligned} \hat{x}^{\hat{2}} &= \hat{x}^\mu \hat{\times} \hat{\eta}_{\mu\nu} \hat{\times} \hat{x}^\nu = [x^\mu \times \hat{\eta}_{\mu\nu}(x, d, \tau, \omega, \dots) \times x^\nu] \times \hat{I} = \\ &= [x^\mu \times g_{\mu\nu}(x, d, \tau, \omega, \dots) \times x^\nu] \times \hat{I} = [x^\mu \times \hat{T}_\mu^\rho(x, d, \tau, \omega, \dots) \times \eta_{\rho\nu} \times x^\nu] \times \hat{I} = \\ &= (x^1 \times x^1/n_1^2 + x^2 \times x^2/n_2^2 + x^3 \times x^3/n_3^2 - x^4 \times x^4/n_4^2) \times \hat{I} = \\ &= (x^1 \times x^1 \times b_1^2 + x^2 \times x^2 \times b_2^2 + x^3 \times x^3 \times b_3^2 - x^4 \times x^4 \times b_4^2) \times \hat{I} \in \hat{R}, \quad (6.1.8) \end{aligned}$$

where the n 's or the b 's are called the *characteristic quantities* of the medium considered and they are normalized to the corresponding values in vacuum, i.e. in vacuum we have for the index of refraction $n_4 = 1/b_4 = 1$ for which $c = c_o$, and the space components are normalized to the value of the perfect sphere (the unit of the Euclidean geometry), $n_1 = n_2 = n_3 = 1/b_1 = 1/b_2 = 1/b_3 = 1$. Note that for mathematical rigor, we should have used in Eqs. (6.1.8) the *isoquotient* $\hat{/} = / \times \hat{I}$ and all characteristic quantities should have been *isonumbers*, e.g., $\hat{n}_\alpha = n_\alpha \times \hat{I}$, resulting in the simplification used in the preceding isoelement $\hat{/}\hat{n}_\alpha = /n_\alpha$.

It should be noted that *the characteristic quantities provide a direct geometrization (that is, a geometrization via the isometric) of the deviation from the Minkowskian geometry for the vacuum caused by physical media*. Hence, the characteristic quantities $b_k = 1/n_k$, $k = 1, 2, 3$, characterize the geometric deviations from the Euclidean space for the motion of extended particle or electromagnetic waves within physical media, while the quantity $b_4 = 1/n_4$ characterizes the deviation from the Minkowskian time.

Note the *direct universality* of the isoline (6.1.8) in the sense that it includes as particular cases all possible line elements with signature $(+, +, +, -)$, thus including the Minkowskian, Riemannian, Finslerian, and any other possible line

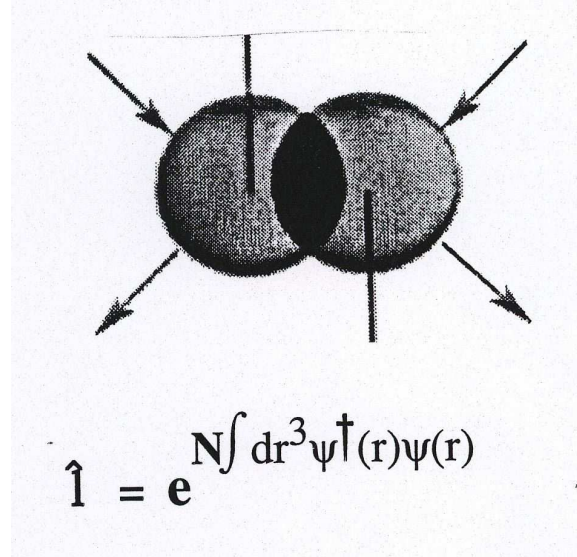

Figure 6.2. A schematic view of the *new interactions* studied in these volumes: the contact, zero-range, nonlinear, nonlocal and nonpotential interactions typical of all interior dynamical problems originating in deep mutual penetration of the wavepackets and/or charge distributions of particles as occurring in the hadronic structure, inelastic scattering, electron valence bonds, and numerous other events. Special relativity and quantum mechanics can only represent *dimensionless point-like particles*, as expected as being admitted by experts to qualify as such. Additionally, their Hamiltonians can only represent action-at-a-distance interactions derivable from a potential. Consequently, it was popularly believed throughout the 20-th century that the interactions herein considered do not exist resulting in a plethora of assumptions, insufficiencies or inconsistencies studied in details in Chapter I.1. The studies reported in these volumes required decades of research because of the difficulties, not only in representing interactions outside the capabilities of the Hamiltonian, but also achieving their *invariant representation*, i.e., a representation that would not change over time and other symmetry transformations. Following numerous trials and errors, the only consistent solution identified by the author is the representation of all non-Hamiltonian interactions and effects with a generalization of the basic unit, today known as *Santilli isounit* because the unit is the most fundamental invariant of all theories.

elements. Such a universality is said to be direct because it occurs in the space-time of the experimenter without any need for coordinate transforms. Note that, also for simplicity, we have used the *diagonal* form of the isoline isoelement. For the general nondiagonal form the interested reader may study EHM-II.

Systematic studies were conducted by Santilli on the invariance of universal line element (6.1.8), via the isotopies of: Lorentz symmetry [4a,4b]; rotational symmetry [5a,5b]; SU(2)-spin symmetry [5c,5d]; Poincaré symmetry [5e,5f]; and spinorial covering of the Poincaré symmetry [5g] (see monographs [6] for a com-

prehensive study as of 1991, and EHM, Vols. I and II, as well as Volume I of this series for details).

All preceding efforts were re-examined and further developed in paper [96] for the relativistic structure model of the neutron as a hadronic bound state of a proton and an electron studied in detail in Section 6.2.8. The most effective way to learn these advances is within the context of a specific application. Hence, we defer their treatment to Section 6.2.8 and limit ourselves here to quote the following *Lorentz-Santilliisotransformations* in the (3,4) plane (see EHM-II for the general case) that are at the foundation of these entire two volumes

$$x^{1'} = x^1, \quad x^{2'} = x^2, \quad (6.1.9a)$$

$$x^{3'} = \hat{\gamma} \times \left(x^3 - \frac{n_3}{n_4} \times \hat{\beta} \times x^4\right) = \hat{\gamma} \times \left(x^3 - \frac{b_4}{b_3} \times \hat{\beta} \times x^4\right), \quad (6.1.9b)$$

$$x^{4'} = \hat{\gamma} \times \left(x^4 - \frac{n_4}{n_3} \times \hat{\beta} \times x^3\right) = \hat{\gamma} \times \left(x^4 - \frac{b_3}{b_4} \times \hat{\beta} \times x^3\right), \quad (6.1.9c)$$

$$\hat{\gamma} = (1 - \hat{\beta}^2)^{-1/2}, \quad \hat{\beta} = v \times b_3/c_o \times b_4 = v \times n_4/c_o \times n_3, \quad (6.1.9d)$$

$$\hat{I} = \text{Diag.}(1/b_1^2, 1/b_2^2, 1/b_3^2, 1/b_4^2) = \text{Diag.}(n_1^2, n_2^2, n_3^2, n_4^2), \quad (6.1.9r)$$

formulated on ordinary space, rather than isospace, for simplicity.

Note that, by conception and construction, the Lorentz-Santilli isosymmetry is locally isomorphic to the conventional Lorentz symmetry, $\hat{O}(3.1) \approx O(3.1)$. Hence, the author introduced the word "isotopies" to denote, in the Greek meaning of the word, the preservation of the original axioms.

An important property, also discovered by R. M. Santilli [5], is that, contrary to popular beliefs, *the Lorentz symmetry is seven and not six dimensional*. This is due to the new *isotopic invariance* here expressed for a constant number $z \in R$

$$x^2 = (x^\mu \times \eta_{\mu\nu} \times x^\nu) \times I \equiv [x^\mu \times (z^2 \times \eta_{\mu\nu}) \times x^\nu] \times (z^{-2} \times I) = (x^\mu \times \hat{\eta}_{\mu\nu} \times x^\nu) \times \hat{I}. \quad (6.1.10)$$

As we shall see, and as expected for any new invariance in our spacetime, the novel invariance (6.1.10) carries fundamental implications at all levels of study, from particle physics to cosmology, including far reaching advances such as the first known axiomatically consistent grand unification of electroweak and gravitational interactions studied in Chapter 14.

The fact that the new isoinvariance (6.1.10) remained un-noticed throughout the 20-th century until identified in Ref. [5] should not be surprising because its identification required the prior discovery of *new numbers*, Santilli's isonumbers with arbitrary positive-definite unit \hat{I} .

From now on we shall use the following terminology: the use of conventional terms, such as speed, mass, energy, etc., will denote conventional quantities defined on the conventional Minkowski space over the conventional field of real

numbers. Terms such as *isospeed*, *isomass*, *isoenergy*, etc. will denote quantities defined on the Minkowski-Santilli isospace over the isofield of real numbers.

Santilli isorelativity (see Volume I as well as monographs [6] (as well as EHM-II and HM-I) and original references quoted therein) is based on the Poincaré-Santilli isosymmetry and the following isoaxioms (see Section I.3.5 for details):

ISOAXIOM I. The projection in our spacetime of the maximal causal invariant speed is given by:

$$V_{max} = c_o \times \frac{b_4}{b_3} = c_o \times \frac{n_3}{n_4} = \frac{c}{b_3} = c \times n_3 = c_o \times \frac{g_{44}^{1/2}}{g_{33}^{1/2}}. \quad (6.1.11)$$

ISOAXIOM II. The projection in our spacetime of the isorelativistic addition of speeds within physical media is given by:

$$v_{tot} = \frac{v_1 + v_2}{1 + \frac{v_1 \times b_3^2 \times v_2}{c_o \times b_4^2 \times c_o}} = \frac{v_1 + v_2}{1 + \frac{v_1 \times n_4^2 \times v_2}{c_o \times n_3^2 \times c_o}} = \frac{v_1 + v_2}{1 + \frac{v_1 \times g_{33} \times v_2}{c_o \times g_{44} \times c_o}}. \quad (6.1.12)$$

ISOAXIOM III. The projection in our spacetime of the isorelativistic laws of dilation of time t_o , contraction of length ℓ_o and variation of mass m_o with speed are given respectively by:

$$t = \hat{\gamma} \times t_o, \quad (6.1.13a)$$

$$\ell = \hat{\gamma}^{-1} \times \ell_o, \quad (6.1.13b)$$

$$m = \hat{\gamma} \times m_o. \quad (6.1.13c)$$

ISOAXIOM IV. The projection in our spacetime of the Doppler-Santilli isolaw is given by the law (here formulated for simplicity for 90° angle of aberration):

$$\omega = \omega_o \times \frac{1 - \hat{\beta} \times \hat{c} \hat{o} \hat{s} \hat{\theta}}{\sqrt{1 - \hat{a} \hat{b} \hat{\beta} \hat{a}^2}}, \quad (6.1.14)$$

ISOAXIOM V. The projection in our spacetime of the isorelativistic law of equivalence of mass and energy is given by:³

$$E = m \times V_{max}^2 = m \times c_o^2 \times \frac{b_4^2}{b_3^2} = m \times c_o^2 \times \frac{n_3^2}{n_4^2}. \quad (6.1.15)$$

³As indicated in Section 3.5, the initial formulation of Isoaxiom V was

$$E = m \times c^2 = m \times c_o^2 \times b_4^2 = \frac{m \times c_o^2}{n_4^2}.$$

However, experimental verifications of isorelativity proved this formulation to be wrong, and had to be replaced with isolaw (6.1.15). The occurrence reinforced the view that, contrary to popular beliefs in the 20-th century, *the speed of light is not, in general, the maxima. causal speed because physical media are generally opaque to light, in which case the use of the speed of light has no mathematical or physical meaning.* It happens that in vacuum $b_3 = b_4 = 1$ and in water $b_3 = b_4$, in which case $V_{max} = c_o$, but this is a mere particular case without universal validity.

In the above isoaxioms we have

$$\hat{\beta} = v \times b_3/c_o \times b_4 = v \times n_4/c_o \times n_3 = v/V_{max}, \hat{c} \hat{o} s \hat{\theta} = \cos(\theta \times b_s) \quad (6.1.16)$$

Since v is always smaller than or equal to the maximal causal speed V_{max} , $\hat{\beta}$ is always smaller than or equal to one and $\hat{\gamma} = (1 - \hat{\beta}^2)^{-1/2}$ cannot take imaginary values as it is the case for special relativity. For isotrigonometric functions, we refer the reader for brevity to EHM Vol. I. For detailed studies of the iso-Doppler law, one may consult EHM Vol./ II, Section 8.5.F.

Note that *the isoaxioms are not isotopies of the corresponding axioms of special relativity, because they characterize major structural departures, such as; the the maximal local speed is not, in general, the speed of light; the energy equivalence is not given by the familiar expression $E = m \times c^2$; etc.* These structural deviations emerge only within physical media and have major implications we shall study later on, such as the elimination of any need for dark matter..

As we shall see, these deviations are requested by experimental evidence. For instance, in the event the maximal causal speed would be the local speed of light, isorelativity would be violated by water where ordinary electrons can propagate faster than the local speed of light. On the contrary, water is homogeneous and isotropic. Consequently, for water we have $b_3 = b_4$ and the maximal causal speed *in water* is given by the speed of light *in vacuum*. In this case isorelativity verifies causality laws because ordinary electrons travels in water at speeds smaller then the local maximal causal speed. The other axioms are equally verified, such as the isorelativistic sum of speeds (see Section 6.1.7 for details).

The above structural deviations from special relativity can be understood by noting that the main meaning of the new isoaxioms is isogeometrical. Recall that the isotopies reconstruct on isospaces over isofield "all" original axioms identically. For instance, the isoimage of an hyperboloid is the perfect isosphere, the isoimage of the deformation of the light cone caused by variable speeds of light is the perfect light isocone, etc. These exact reconstructions are, evidently, at the foundations of the reconstruction of exact spacetime and internal symmetries when popularly believed as being broken due to the use of excessively elementary mathematics.

The mechanism of achieving this reconstruction is given by the lifting of any given physical quantity, say, $v^2 \rightarrow v^2 \times b_3^2$ while the corresponding unit is lifted of the *inverse* amount, $I = 1 \rightarrow \hat{I} = 1/b_3^2$. The exact reconstruction then follows from isoinvariance (6.1.10).

By the same argument, *the isotopic image of all physical media is given by the perfect isovacuum, that is, the vacuum referred to the Minkowski-Santilli isospace lover isofields.* In fact, the maximal causal speed on isospaces over isofields is the speed of light *in vacuum*, otherwise the Lorentz-Santilli isosymmetry could not be isomorphic to the conventional Lorentz symmetry.

ISOMINKOWSKIAN CLASSIFICATION OF PHYSICAL MEDIA

GROUP I $\hat{\beta} \equiv \beta, \hat{\gamma} = \gamma;$	{	<p>TYPE 1: $n_s = n_4, n_4 = 1;$</p> <p>TYPE 2: $n_s = n_4, n_4 > 1;$</p> <p>TYPE 3: $n_s = n_4, n_4 < 1;$</p>
GROUP II: $\hat{\beta} > \beta, \hat{\gamma} \equiv \gamma;$	{	<p>TYPE 4: $n_s < n_4, n_4 = 1;$</p> <p>TYPE 5: $n_s < n_4, n_4 > 1;$</p> <p>TYPE 6: $n_s < n_4, n_4 < 1;$</p>
GROUP III: $\hat{\beta} < \beta, \hat{\gamma} > \gamma;$	{	<p>TYPE 7: $n_s > n_4, n_4 = 1;$</p> <p>TYPE 8: $n_s > n_4, n_4 > 1;$</p> <p>TYPE 9: $n_s > n_4, n_4 < 1;$</p>

Figure 6.3. A view of the classification of physical media permitted by the Minkowski-Santilli isogeometry first proposed in Ref. [6] of 1991 (see also Figure 8.5.1 of EHM-II and Ref. [63]).

Under such isogeometrization of physical media, the projection in our space-time of the maximal causal isospeed is not the local speed of light $c = c_o \times b_4$ but instead it is given by the maximal causal speed $V_{max} = c_o \times b_4/b_3$, since isotopies preserve the axiomatic character, the speed of light being an ordinary locally variable quantity under isotopy.

The Minkowski-Santilli isogeometry permits an important classification of physical media (see Figure 6.3) under the following basic characterizations:

1) Spherical symmetry is represented which $b_k = b_s = 1/n_s = 1/n_s, k = 1, 2, 3$, normalized to the value $b_s = n_s = 1$ for the vacuum. Alternatively, n_s can be given in certain cases by the average of the $n_k, k = 1, 2, 3$.

2) The first direct geometric representation known to the author ("direct" because done directly with the metric) of the *density* of the medium considered is done with $b_4 = 1/n_4$ also normalized to the value $b_4 = n_4 = 1$ for the vacuum;

3) The direct geometric representation of the general *inhomogeneity* of the medium is done via a dependence of the characteristic quantities on the local radial distance r and other variables, $b_s = b_s(r, \dots) = 1/n_s(r, \dots)$. Such a local variations can be averaged to constants for simplicity.

4) The direct geometric representation of the general *anisotropy* is done via a difference between the space and time characteristic quantities, $b_s \neq b_4, n_s \neq n_4$.

5) The direct geometric representation of the *locally varying speed of light*, the maximal causal speed and the other features of isorelativity are done via Isoaxioms I to V.

The above characterizations provide the following *classical iso-Minkowskian classification of physical media* first presented in Ref. [6] of 1991, Section IV-10 (see also Ref. [63] and EHM II):

GROUP I: characterized by $n_s = n_4$, $n_4 = 1, > 1, < 1$.

These media possess the same homogeneity and isotropy of space (vacuum).

GROUP II: characterized by $n_s < n_4$, $n_4 = 1, > 1, < 1$.

These media are inhomogeneous and isotropic with low density.

GROUP III: characterized by $n_s > n_4$, $n_4 = 1, > 1, < 1$.

These media are inhomogeneous and anisotropic with high density.

GROUP I, TYPE 1: $n_s = n_4$, $n_4 = 1$, $\hat{\beta} = \beta$, $\hat{\gamma} = \gamma$, $c = c_o$, $V_{max} = c_o$, $V_{max} = c$, $V_{max} = c$.

This case represents empty space (vacuum);

GROUP I, TYPE 2: $n_s = n_4$, $n_4 > 1$, $\hat{\beta} = \beta$, $\hat{\gamma} = \gamma$, $c < c_o$, $V_{max} = c_o$, $V_{max} > c$.

These homogeneous and isotropic media originate from the isotopic invariance of the line element, Eq. (6.1.10), for $z^2 < 1$; they are transparent to light (because $V_{max} > c$); and they represent ordinary homogeneous and isotropic media such as water, or transparent liquids in general.

GROUP I, TYPE 3: $n_s = n_4$, $n_4 < 1$, $\hat{\beta} = \beta$, $\hat{\gamma} = \gamma$, $c > c_o$, $V_{max} = c_o$, $V_{max} < c$,

These homogeneous and isotropic media also originate from isotopic invariance (6.1.10) for $z^2 > 1$, and they constitute the *new media* predicted by isorelativity. A possible candidate is given by *superconductors*, as studied in Chapter 8 with electrons moving at the maximal causal speed $V_{max} = c_o$. These media can be either opaque to light (because $V_{max} < c$), or be transparent, in which case $c_{max} = V_{max}$ because the speed of light is not the maximal causal speed, but an ordinary local speed, thus being bounded by V_{max} . In case the media are opaque to light, $b_4 = 1/n_4$ preserves its meaning as a geometrization of the density with significant meaning, such as the fact that media of Type 3 are more dense than those of Type 2 (because $c_{I,3} > c_{I,2}$).

GROUP II, TYPE 4: $n_s < n_4$, $n_4 = 1$, $\hat{\beta} < \beta$, $\hat{\gamma} > \gamma$, $c = c_o$, $V_{max} < c_o$, $V_{max} < c$.

These media are the first to be non trivial, in the sense that they cannot be derived from the isotopic invariance (6.1.10). Hence, they are inhomogeneous and anisotropic, and they are generally transparent to light, in which case $c_{max} = V_{max}$, although the case of media opaque to light (with $V_{max} < c$ should not be excluded. Expected candidates for these media are planetary atmospheres

or astrophysical chromospheres because they are of generally low density, inhomogeneous (due to the radial variation of the density) and anisotropic (due to rotations establishing a preferred direction in space). These features require a necessary departure from the Minkowskian spacetime with deep astrophysical implications, e.g., in current unfounded beliefs on cosmological redshifts. Another expected case is given by the media inside light unstable particles, such as pions, as studied in Section 6.1.7. Other expected media of this type are given by ordinary conductors.⁴

GROUP II, TYPE 5: $n_s < n_4$, $n_4 > 1$, $\hat{\beta} < \beta$, $\hat{\gamma} > \gamma$, $c < c_o$, $V_{max} < c_o$, $V_{max} \leq c$.

These are inhomogeneous and anisotropic media of generally low to moderate density (because the maximal possible speed of light is smaller than that in vacuum). As such, these media are significant for astrophysical chromospheres and other interior bodies. In fact, we shall show in Section 6.1.11 that the huge inhomogeneous and anisotropic chromospheres of quasars are media precisely of this type. Intriguingly, the same holds for the medium inside light hadrons, as shown in Section 6.1.8.

GROUP II, TYPE 6: $n_s < n_4$, $n_4 < 1$, $\hat{\beta} < \beta$, $\hat{\gamma} > \gamma$, $c > c_o$, $V_{max} < c_o$, $V_{max} < c$.

These media too are inhomogeneous and anisotropic with expected low to moderate density. Examples are given by nuclei that are indeed, inhomogeneous and anisotropic, yet treated with the homogeneous and isotropic Minkowskian spacetime and related Poincaré symmetry, despite the fact that nuclei have no nuclei (Figure 6.1) in which case the assumption of the exact Poincaré symmetry and special relativity is mere theological, as studied in Chapter 7. The differences between media of Group II, Types 4, 5, 6 are expected to represent significant geometric differences ignored during the 20-th century because, again, nature was adapted to the homogeneous and isotropic spacetime of special relativity.

GROUP III, TYPE 7: $n_s > n_4$, $n_4 = 1$, $\hat{\beta} < \beta$, $\hat{\gamma} > \gamma$, $c = c_o$, $V_{max} > c_o$, $V_{max} > c$.

This is the first of three inhomogeneous and anisotropic media of high density that are of primary relevance for hadronic mechanics because representing the hyperdense media inside hadrons, stars, quasars and other internal astrophysical

⁴By ignoring all other arguments and experimental evidence studied in these volumes, the sole privileged space directions possessed by atmospheres or chromospheres, particles such as hadrons, and conductors at large is sufficient to prohibit the exact validity of Einsteinian doctrines due to their strict isotropic character, since anisotropy has deep geometric and dynamical implications. The appropriate broadening of Einsteinian doctrines that is applicable for basic advances in the representation of anisotropic systems, is indeed open to scientific debates, by the denial of its need is scientific corruption for personal gain in maintaining pre-established doctrines.

problems. All media of this group have $V_{max} > c_o$ and $V_{max} > c$. The first of these three media has the geometric significance that the speed of light is the same as that in vacuum, $c = c_o$.

GROUP III, TYPE 8: $n_s > n_4$, $n_4 > 1$, $\hat{\beta} < \beta$, $\hat{\gamma} > \gamma$, $c < c_o$, $V_{max} > c_o$, $V_{max} > c$.

This is a second type of inhomogeneous and anisotropic media of high density that is conceivable for extreme astrophysical conditions, such as those in the interior of black holes, in which the maximal causal speed is expected to have no limit, but the speed of light is expected to be much smaller than that in vacuum, assuming that light can even propagate in media of such extreme densities.

GROUP III, TYPE 9: $n_s > n_4$, $n_4 < 1$, $\hat{\beta} < \beta$, $\hat{\gamma} > \gamma$, $c > c_o$, $V_{max} > c_o$, $V_{max} > c$, $V_{max} > c$.

These media are experimentally verified in the interior of heavy hadrons (Section 6.1.7, 6.1.8, 6.1.9), in the interior of the fireball of the Bose-Einstein correlation (Section 6.1.10) and other hyperdense inhomogeneous and anisotropic media. As we shall see, these last media do indeed permit the prediction, quantitative development and industrial realization of basically "new" clean energies, such as energies originating from mechanism in the interior of the neutron, rather than in a nuclear structure. Due to their societal need, readers are alerted that *technical* criticisms are solicited, welcome and appreciated as part of a serious scientific process, but opposition based on tangential issues without technical relevance will be denounced as a threat to society.

Santilli isodual isorelativity for the characterization of antimatter can be easily constructed via the isodual map of Chapter I.3, and its explicit study is left to the interested reader for brevity. For recent studies on Santilli isorelativity one may consult A. K. Aringazin [7], J. F. Kadeisvili [8], K. Masuda [9], and monographs [19-24].

The reader should remember from Volume I that isorelativity unifies the special and the general into one single relativity. The unification is done beginning at the level of unification of the Minkowskian and Riemannian geometries [10] and carries over at all subsequent levels. In fact, isoelement (6.1.8) is inclusive of all possible Riemannian line elements as indicated earlier, and the Lorentz-Santilli isosymmetry $\hat{O}(3, 1)$ is the universal symmetry of all possible Riemannian gravitation, first presented in Ref. [5].

However, a necessary condition for the achievement of a universal *symmetry* for all gravitational models is the abandonment of curvature since gravitation is represented in the Minkowski-Santilli isospace that is isoflat. This occurrence can also be seen from the fact that *isogravitation* [11] is characterized by

1) Factorizing any Riemannian $g(x)$ metric into a 4×4 matrix $\hat{T}(x)$ and the Minkowskian metric,

$$g_{\mu\nu} = \hat{T}_\mu^\rho(x) \times \eta_{\rho\nu}, \quad (6.1.17)$$

2) Assuming $\hat{T}(x)$ as the inverse of the new isounit,

$$\hat{I}(x) = 1/\hat{T}(x), \quad (6.1.18)$$

3) Formulating the line element with Riemannian isometric $g(x) = \hat{T}(x) \times \eta$ as an *isonumber*, that is, with respect to the isounit $\hat{I}(x) = \hat{T}(x)$,

$$\hat{x}^{\hat{2}} = [x^t \times (\hat{T} \times \eta) \times x] \times \hat{I}, \quad (6.1.19)$$

in which case the curvature represented by $\hat{T}(x)$ is essentially "cancelled out" by its inverse $\hat{I}(x)$.

The noninitiated reader should be aware that the conventional formulation of gravity, that on a curved manifold, is afflicted by numerous theorems of catastrophic mathematical and physical inconsistencies studied in details in Chapter I.1., Ref. [13], and briefly outlined in Section I.1.4. Isogravitation was formulated as the only way known to the author to bypass these inconsistency theorems, that by eliminating curvature in favor of broader geometric views [10].

A main result is the achievement in Ref. [12] of the apparently first known, axiomatically consistent grand unification of electroweak and gravitational interactions, where "axiomatically consistency" is referred to the inclusion of both matter and antimatter (the latter being rather universally ignored in grand unifications), the use of a consistent operator formulation of gravity [11], e.g., verifying the PCT theorem, and admitting compatible symmetries.

A central objective of this volume is to present a variety of experimental verifications of isorelativity for interior dynamical conditions in different fields.

6.1.5 Rudiments of Hadronic Mechanics

For minimal self-sufficiency of this volume, let us also recall that the *isotopic branch of nonrelativistic or relativistic hadronic mechanics* (first proposed in memoirs [14] of 1978) can be constructed via techniques similar to those of the preceding subsection. Any given quantum model can be lifted into the covering hadronic version via the use of a nonsingular, positive-definite, nonunitary transform on a *Hilbert space* \mathcal{H} over the field of complex numbers \mathcal{C} .

We first have the lifting of *Planck's constant* into a isounit that is positive definite (thus invertible) but otherwise possesses an unrestricted functional dependence on time t , local coordinates r , linear momentum p , wavefunctions ψ , and any other needed variable,

$$\hbar \rightarrow \hat{I}(t, r, p, E, \psi, \dots) = 1/\hat{T}(t, r, p, \psi, \dots) = U \times U^\dagger > 0, \quad (6.1.20)$$

where the dependence on energy E is trivially derived from the unrestricted dependence on the linear momentum and coordinates (see EHM-II).

The above lifting represents the impossibility of conventional quantum orbits in the hyperdense medium inside hadrons, nuclei and stars (if nothing else, due to the absence of a Keplerian structure and the consequential inapplicability of conventional Poincaré symmetry).

Lifting (6.1.20) is restricted to verify the general condition

$$\text{Lim } \hat{I}_{r \gg 1 \text{ fm}} \equiv \hbar \tag{6.1.21}$$

assuring that hadronic mechanics recovers quantum mechanics uniquely and identically at sufficiently large mutual distances of particles., thus including the recovering of conventional quantized orbits (that exist only for distances much bigger than 1 fm).

Compatibility conditions (6.1.21) will soon appear crucial for the understanding of the compatibility of our structure model of the neutron as a hadronic bound states of a proton and an electron and the conventional structure of the hydrogen atom.

We then have the lifting of \mathcal{H} into the *Hilbert-Santilli isospace* $\hat{\mathcal{H}}$ expressible via the following lifting of states. inner products and expectation values of a (Hermitean) operator A

$$|\psi \rangle \in \mathcal{H} \rightarrow |\hat{\psi} \rangle = U \times |\psi \rangle \in \hat{\mathcal{H}}, \tag{6.1.22a}$$

$$\begin{aligned} \langle \psi | \times |\psi \rangle \times I \in R &\rightarrow U \times (\langle \psi | \times |\psi \rangle \times I) \times U^\dagger = \\ &= \langle \psi | \times U^\dagger \times (U \times U^\dagger)^{-1} \times U \times |\psi \rangle \times U \times I \times U^\dagger = \\ &= \langle \hat{\psi} | \hat{\times} | \hat{\psi} \rangle \times \hat{I} \in \hat{C}, \end{aligned} \tag{6.1.22b}$$

$$\begin{aligned} \langle A \rangle = \langle \psi | \times A \times |\psi \rangle \times I &\rightarrow U \times (\langle \psi | \times A \times |\psi \rangle \times I) \times U^\dagger = \\ &= \langle \hat{\psi} | \hat{\times} \hat{A} \hat{\times} | \hat{\psi} \rangle \times \hat{I} = \langle \hat{A} \rangle. \end{aligned} \tag{6.1.22c}$$

We then have the identity

$$\langle \hat{I} \rangle \equiv I = \hbar, \tag{6.1.23}$$

illustrating the fact that deviations from conventional quantization processes are *internal* and not necessarily detectable from exterior conditions.

Similarly, we have the lifting of Heisenberg's equations into the *Heisenberg-Santilli isoequations* first proposed in Ref. [14b] of 1978 (see memoir [15] of 1996 for the first formulation via the *isodifferential calculus*)

$$i \times \frac{dA}{dt} = [A, H] \rightarrow U \times (i \times \frac{dA}{dt}) \times U^\dagger =$$

$$\begin{aligned}
&= \hat{i} \hat{\times} \frac{d\hat{A}}{d\hat{t}} = i \times \hat{I}_t \times \frac{d\hat{A}}{d\hat{t}} = \\
&= U \times [A, H] \times U^\dagger = [\hat{A}, \hat{H}] = \hat{A} \times \hat{T}_r \times \hat{H} - \hat{H} \times \hat{T}_r \times \hat{A}, \quad (6.1.24)
\end{aligned}$$

where one should note isounits of time and space denoted with the subindices t, r , respectively (generally ignored whenever there is no ambiguity).

Similarly, we have the lifting of canonical commutation rules into *isocanonical isocommutation rules* also introduced for the first time in memoir [14]

$$[r^i, p^j] = i \times \delta_j^i \rightarrow [\hat{r}^i, \hat{p}_j] = \hat{i} \hat{\delta}_j^i = i \times \hat{I} \times \delta_j^i, \quad (6.1.25)$$

Similarly, we have the lifting of the Schrödinger equations into the *Schrödinger-Santilli isoequations* first formulated in an invariant form in memoir [15]

$$\begin{aligned}
&i \times \hbar \times \frac{\partial}{\partial t} |\psi \rangle = H \times |\psi \rangle \rightarrow \\
&\rightarrow \hat{i} \hat{\times} \frac{\hat{\partial}}{\hat{\partial t}} |\hat{\psi}(\hat{t}, \hat{r}) \rangle = i \times \hat{I}_t \times \frac{\partial}{\partial t} = \\
&= \hat{H} \hat{\times} |\hat{\psi} \rangle = \hat{H}(\hat{r}, \hat{p}) \times \hat{T}_r(\hat{t}, \hat{r}, \hat{p}, \hat{E}, \hat{\psi}, \dots) \times |\hat{\psi} \rangle. \quad (6.1.26)
\end{aligned}$$

and the lifting of the linear momentum into *isolinear isomomentum* (reached for the first time in memoir [15] following decades of search due to the preceding absence of the isodifferential calculus

$$\begin{aligned}
&p_k \times |\psi \rangle = -i \times \hbar \times \partial_k |\psi \rangle \rightarrow U \times (p_k \times |\psi \rangle) = \\
&= U \times p_k \times (U \times I^\dagger)^{-1} \times U \times |\psi \rangle = \hat{p}_k \hat{\times} |\hat{\psi} \rangle = -U \times (i \times \hbar \times \partial_k |\psi \rangle) = \\
&= -\hat{i} \hat{\times} \hat{\partial}_k |\hat{\psi} \rangle = -i \times \hat{I}_k^i \times \partial_i |\hat{\psi} \rangle, \quad (6.1.27)
\end{aligned}$$

We should also recall the new invariance of the conventional inner product under isotopic transforms here expressed for a non-null constant $z \in R$

$$\langle \psi | \times |\psi \rangle \times I \equiv \langle \psi | \times z^2 \times | \psi \rangle \times (z^{-2} \times I) \equiv \langle \psi | \hat{\times} | \psi \rangle \times \hat{I}, \quad (6.1.28)$$

with extension to an arbitrary positive-definite nonunitary transform and isounit $U \times U^\dagger = \hat{I} > 0$ via the techniques of Volume I.

Note the *abstract identity of hadronic and quantum mechanics* as illustrated by the property that all relative equations and physical laws are merely differentiated by a "hat" denoting the existence of a *broader realization* of the same axioms.

The above occurrences forcefully establishes the validity of nonrelativistic and relativistic hadronic mechanics in the conditions of their applicability, evidently because of the preservation of the conventional axioms of quantum mechanics.

In turn, this forcefully establishes the validity of the Minkowski-Santilli isospaces for interior particle conditions as verified below.

Alternatively, the preservation of the abstract axioms in the transition from quantum to hadronic mechanics renders nonscientific the aprioristic selection of any of them, since the only scientific selection of the truly applicable mechanics for given conditions, that via experiments.

Note that the preceding isoequations also provide an explicit realization of *operator isogravity*, first submitted at the Marcel Grossmann meeting of 1998 [12] under the mere realization of the isounit and isotopic elements as the gravitational forms (6.1.18), (6.1.9). The consistency of operator isogravity, including the verification of the PCT theorem, is assured by the preservation of the abstract axioms of conventional relativistic quantum mechanics.

Independent reviews of hadronic mechanics are provided by monographs [19-24]. A large number of independent papers written during the last three decades can be found in the general bibliography at the end of this volume.

6.1.6 Catastrophic Mathematical and Physical Inconsistencies of Noncanonical and Nonunitary Theories

As it is well known, classical canonical theories, or operator unitary theories, are Hamiltonian in the sense that they represent the entire system considered via the sole knowledge of a Hamiltonian. Consequently, the representation of new effects beyond the representational capabilities of a Hamiltonian, such as nonpotential interactions, has requested the use of noncanonical or nonunitary theories, e.g., theories whose time evolution verifies condition

$$U(t) \times U(t)^\dagger \neq I, \quad (6.1.29)$$

formulated on conventional mathematics.

A knowledge truly crucial for the understanding of this volume (studied in details in Section I.1.5 Theorem I.1.5.2) is that the latter theories are afflicted by the following catastrophic inconsistencies:

THEOREM 6.1 [25-32]: All noncanonical and nonunitary theories formulated via the mathematics of canonical or unitary theories (conventional numbers, spaces, functional analysis, etc.) are afflicted by catastrophic mathematical and physical inconsistencies.

On mathematical grounds, by their very definition, noncanonical and nonunitary theories do not preserve the unit,

$$I \rightarrow I' = U \times I \times U^\dagger \neq I. \quad (6.1.30)$$

Consequently, noncanonical and nonunitary theories do not preserve over time the unit I of their base fields, with consequential catastrophic collapse over time of the entire mathematical structure, including spaces, algebras, geometries, symmetries, etc. since all of them remain formulated over a base field no longer applicable at later time. An identical situation occurs under all other automorphism

On physical grounds, units of Lie symmetries represent units of measurements. For instance, the unit of the Euclidean geometry $I = \text{Diag.}(1, 1, 1)$ represents in an abstract dimensionless form units actually used in tests, such as $I = \text{Diag.}(1 \text{ cm}, 1 \text{ cm}, 1 \text{ cm})$. Consequently, a theory with a noncanonical or nonunitary time evolution necessarily alters the numerical values of the basic units used in measurements, such as, for instance, in the case

$$\begin{aligned} I = \text{Diag.}(1 \text{ cm}, 1 \text{ cm}, 1 \text{ cm}) &\rightarrow U \times I \times U^\dagger = I = \\ &= \text{Diag.}(7.3 \text{ cm}, 345 \text{ cm}, 0.003 \text{ cm}), \end{aligned} \quad (6.1.31)$$

thus preventing any meaningful application in dynamics.

Noncanonical and nonunitary theories have additional catastrophic physical inconsistencies, such as they do not preserve over time the Hermiticity and, hence, the observability of physical quantities, namely, an operator H that is Hermitean at the initial time is not necessarily Hermitean at a subsequent time (this property is known as the *Lopez Lemma* [26,27], Eq. (I.1.5.52), i.e.

$$\begin{aligned} &[\langle \psi | \times U^\dagger \times (U \times U^\dagger)^{-1} \times U \times H \times U^\dagger] \times U |\psi \rangle = \\ &= \langle \psi | \times U^\dagger \times [(U \times H \times U^\dagger) \times (U \times U^\dagger)^{-1} \times U |\psi \rangle] = \\ &= (\langle \hat{\psi} \times T \times H^\dagger) \times |\hat{\psi}\rangle = \langle \hat{\psi} | \times (\hat{H} \times T \times |\hat{\psi}\rangle), \end{aligned} \quad (6.1.32a)$$

$$|\hat{\psi}\rangle = U \times |\psi\rangle, \quad T = (U \times U^\dagger)^{-1} = T^\dagger, \quad (6.1.32b)$$

$$H^\dagger = T^{-1} \times \hat{H} \times T \neq H. \quad (1.5.32c)$$

where the loss of observability follows from the general lack of commutativity of H and T . Similarly, noncanonical and nonunitary theories generally violate causality (we teach in first year graduate school of physics that the causality verified by quantum mechanics is due to its unitary structure), and other serious catastrophes.

In view of these occurrences, all papers with a noncanonical or nonunitary structure formulated with conventional mathematics, are catastrophically inconsistent and should not be considered for any serious scientific study.

Isorelativity and hadronic mechanics avoid these inconsistencies thanks to the prior discovery of new mathematics specifically constructed for the task, Santilli iso-, geno- and hyper-mathematics for matter and their isoduals for antimatter

for closed single-valued, open single-valued and open multi-valued conditions, respectively. Theorem 6.1 is bypassed because the new mathematics reconstruct canonicity or unitarity on iso-, geno- and hyper-spaces over iso-, geno-, and hyper-fields, respectively (for brevity see HM-I).

The above mathematical and [physical inconsistencies are typically suffered by the so-called q -deformations with *deformed Lie product* $(A, B) = A \times B - q \times B \times A$, where q is a non-null number. In fact, in this case we have the time evolution in the following infinitesimal and finite form

$$i \times \frac{dA}{dt} = A \times H - q \times H \times A, \quad (6.1.33a)$$

$$A(t) = U \times A(0) \times W^\dagger = (e^{i \times t \times q \times H}) \times A(0) \times (e^{-i \times t \times H}). \quad (6.1.33b)$$

directly activating Theorem 6.1.

These deformations were initiated by R. M. Santilli via paper [33] of 1967 in their broader form $(A, B) = p \times A \times B - q \times B \times A$, where p and q are non-null scalars; they were resumed in 1986 by L. C. Biedenharn [34] and A. J. Macfarlane [35] in the reduced form of the q -deformations; and they subsequently resulted in a river of papers in the field.⁵ Ironically, by the time Biedenharn and Macfarlane elected to study the q -deformations, Santilli had long abandoned the field because of the catastrophic mathematical and physical inconsistencies herein considered.

Another illustration of catastrophically inconsistent theories is given by Ref. [36] of 1999 dealing with a structure dubbed by the authors "deformed Minkowski space" that is entirely identical to the Minkowski-Santilli isospace previously introduced by Santilli [3] in 1983 (including the use of exactly the same symbols!). But this "deformed space" is formulated on conventional fields and elaborated with conventional mathematics, thus being catastrophically inconsistent on mathematical and physical grounds.

In general, *all* theories departing from the conventional structure of Lie's theory (that characterized by unitary transformations on a Hilbert space over the field of complex numbers) verify Theorem 6.1, as it is the case of the *supersymmetries* [37] (see Section I.1.5 for details).

$$(A, B) = \alpha \times (A \times B - B \times A) + \beta \times (A \times B + B \times A) = \alpha \times [A, B] + \beta \times \{A, B\}, \quad (6.1.34)$$

⁵L. C. Biedenharn and A. J. Macfarlane were fully aware of the initiation of the q -deformations by Santilli [33] some twenty years earlier, as proven by the fact that in the early 1980 Biedenharn and Santilli applied for a joint DOE grant, but there was no quotation of the origination [33] in papers [34,35] because of reported ascientific pressures from the Cantabridgean academic community. As a result of this multi-faced ascientific episode, Santilli has been called *the most plagiarized physicist of the 20-th century*.

where α, β are suitable factors depending on the model at hand.⁶

The reader with a young mind of any age as well as independence from orthodox interests can now understand the reason for gravitation defined on a Riemannian space to be catastrophically inconsistent [13] at both the classical and operator levels. In fact, curvature necessarily implies that the time evolution of the theory is necessarily noncanonical at the classical level and nonunitary at the operator level, with direct activation of Theorem 6.1 (de Ref. [13] for a total of *nine theorems of catastrophic inconsistencies of general relativity*). At any rate, general relativity admits no distinction whatever between neutral matter and antimatter. Consequently, any attempt at achieving a consistent operator theory of gravity is doomed to failure.

To avoid a mathematical treatment that may appear excessive to readers due to the applied character of this volume, in this volume we shall study experimental verifications and industrial applications formulated via the *projection* of the formulations in our conventional spacetime over conventional fields, with the clear understanding that their sole correct formulation is on iso-, geno- and hyper-spacetime over iso-, geno- and hyperfields.

6.1.7 Experimental Verifications for Arbitrary Speeds of Light

Isorelativity resolves the inconsistencies of special relativity for classical particles and electromagnetic waves propagating within physical media, including media transparent to light, such as water. In particular, isorelativity provides an *invariant* representation of locally varying speeds of light, while preserving the abstract axioms of special relativity. Since the latter is manifestly inapplicable within physical media, the physical evidence supporting the validity of isorelativity in classical mechanics over special relativity is beyond credible doubt.

Let us consider first the case of water (studied in detail in EHM-II). This medium is homogeneous and isotropic with $c < c_o$ (c in water is about 2/3 of c_o). hence, *water is an iso-Minkowskian medium of Group I, Type 2* (Figure 6.3), thus requiring that Isoaxioms I, Eqs. (6.1.11), holds for $b_3 = b_4$, as a result of which

$$V_{max} = c_o \times \frac{b_4}{b_3} = c_o \quad (6.1.35)$$

⁶Supersymmetric theories are a trivial particular case of Santilli Lie-admissible theory with product

$$\begin{aligned} (A, B) &= A \times P \times B - B \times Q \times A = \\ &= (A \times T \times B - B \times T \times A) + (A \times V \times B + B \times QV \times A) = \\ &= [A;B] + \{A;B\}, \quad P - Q = T, \quad P - Q = V. \end{aligned}$$

Invariance is then achieved via elaborations based on genomathematics (see [18] for brevity).

namely, *the maximal causal speed in water is the speed of light in vacuum*. This resolves the violation of causality suffered by special relativity because electrons in water can travel faster than the local speed of light, but they keep traveling at speeds smaller than the maximal causal speed.

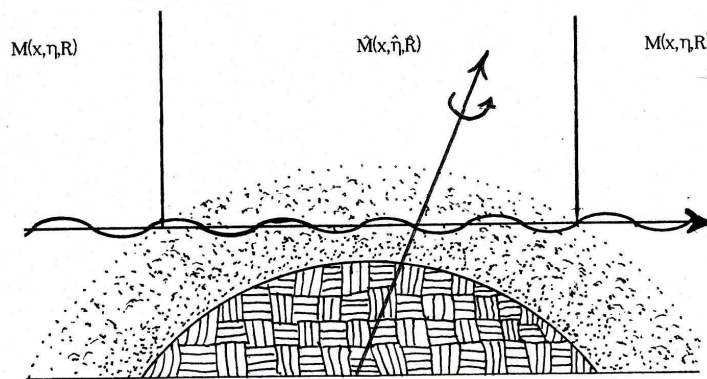

Figure 6.4. An illustration of the spacetime geometries used for the description of electromagnetic waves passing through Earth's atmosphere: the conventional Minkowski geometry is used for propagation in vacuum (exterior problem), and the Minkowski-Santilli isogeometry is used for propagation in Earth's atmosphere (interior problems). The isogeometry has been constructed for a representation of the deviations from the geometry of empty space caused by a physical medium. These deviations do not exist for special relativity because the theory abstracts all particles as idealized points for which physical media do not exist. However, the deviations emerge quite forcefully when particles are represented with their actual extended size, thus rendering inevitable contact, zero-range, nonlocal, nonlinear and nonpotential forces, e.g., of resistive type as experienced by a missile in atmosphere or, equivalently, by an electron moving within the interior of a hadron, or a proton moving in the interior of a star. In Volume I we presented No-Reduction Theorems preventing a consistent reduction of a macroscopic system with contact nonpotential interactions to a hypothetical ensemble of point-like abstractions of particles all in conservative conditions. This established that the contact nonpotential interactions existing in our physical environment originate at the ultimate level of particles, thus establishing the foundations for hadronic mechanics. In this volume we shall present numerous experimental verifications of deviations from the Minkowskian spacetime caused by physical media and then show that said deviations permit the conception and industrial development of new clean energies and fuels that are simply unthinkable for point-like abstractions of particles and their wavepackets.

Isoaxiom II, Eqs. (6.1.12), on the isorelativistic sums of speeds is also verified. For instance, the maximal causal speed verifies the isolaw

$$V_{tot} = \frac{V_{max} + V_{max}}{1 + \frac{V_{max}}{V_{max}}} \equiv V_{max}, \quad (6.1.36)$$

and this resolves the second inconsistency of special relativity in water, the fact that the sum of two maximal causal speeds in water (assumed by special relativity to be necessarily c_o to avoid violation of causality) does not yield the maximal causal speed,

$$V_{tot} = \frac{\frac{2}{3} \times c_o + \frac{2}{3} \times c_o}{1 + \frac{4 \times c_o^2 / 9}{c_o^2}} = \frac{12}{13} \times c_o \neq c_o. \quad (6.1.37)$$

Note that the above resolutions require *the abandonment of the speed of light as the maximal causal speed for motion within physical media, and its replacement with the maximal causal speed* (6.1.11). In fact, physical media are generally opaque to light. It happens that in vacuum these two speeds coincide. However, even in vacuum the correct maximal causal speed remains Eq. (6.1.11) and *not* that of light, as generally believed.

At any rate, to extend the applicability of special relativity beyond the conditions of its original conception, it is popularly believed that the speed of light in vacuum is the maximal causal speed also within physical media in which light cannot propagate. Such a belief has no scientific value or credibility.

The case of classical physical media opaque to light follows the same lines. Special relativity has no meaning when light cannot propagate. Isorelativity applies because physical media represented with conventional spaces over conventional fields are geometrized into a form equivalent to the vacuum when formulated on isospaces over isofields. In fact, the maximal causal speed on isospaces over isofields is c_o and not c (see Volume I for technical aspects). Alternatively, we can say that the vacuum formulated on isospaces over isofields, when projected in our space over conventional fields, characterizes physical media.

The most forceful classical verification of isorelativity is provided by the experimental evidence that electromagnetic waves can propagate within certain guides and other conditions at speeds bigger than the speed of light in vacuum [38,39] conducted at the University of Cologne, Germany, today known as the *Cologne experiment*. These experiments were confirmed via independent tests conducted in Italy (Florence), U.S.A. (Berkeley), Austria (Wien) and France (Orsay and Rennes) (see review [40] of all experimental data on $c > c_o$ up to 2000). Hence, *the existence of electromagnetic waves propagating at speeds bigger than that of light in vacuum is, nowadays, an experimental reality beyond scientific or credible doubt.*

At any rate, an entire Beethoven symphony has been transmitted at speeds $c > c_o$. Any claim of validity of special relativity for these experimental results

would be sheer corruption, for which reasons experimental evidence of speeds $c > c_o$ is often ignored in high energy physics, thus causing problems of scientific ethics and accountability of potentially historical proportions.⁷

The validity of isorelativity and relativistic hadronic mechanics for all possible speeds $c > c_o$ is established quite forcefully by the following facts:

- i) Isorelativity applies for any possible local speed of light c , irrespective of whether smaller or bigger than c_o , the case $c = c_o$ being a trivial particular case;
- ii) Isorelativity is the sole theory providing the invariance of arbitrary local speeds of light;
- iii) Isorelativity is "directly universal," that is, including all conceivably possible (nonsingular) theories for arbitrary speeds of light (universality), directly in the spacetime of the observer without any need to use transformations of local coordinates (direct universality). This is due to the fact that, on one side, the transition from the speed of light in vacuum to locally varying speeds requires noncanonical transformations (Subsection 6.1.2) while, on the other side, isorelativity includes the most general possible noncanonical transforms.
- iv) Isorelativity is the only known theory bypassing the theorems of catastrophic inconsistencies of noncanonical theories (Subsection 6.1.4) thanks to its underlying novel isomathematics;
- v) Isorelativity is the sole new relativity that has permitted scientific and industrial advances on new clean energies and fuels simply inconceivable with special relativity.

The invariant geometrization of speeds $c > c_o$ permitted by isorelativity and relativistic hadronic mechanics is elementary. With reference to experiments [38,39], in the following we outline the treatment via *the isotopic branch of hadronic mechanics*, or *isomechanics*, [8], treated via the *Minkowski-Santilli isogeometry*, although solely referred to the steady segment of the tests, that in between the guides.

The geometrization of the entire process, that starting from propagation in vacuum and then passing through guides, requires the *genotopic branch of hadronic mechanics*, or *genomechanics*, treated via the *Minkowski-Santilli genogeometry* [18] studied in detail in Volume I (see also EHM-II). The latter treatment is excessively advanced for the applied character of this volume and will be presented elsewhere.

To set up notations, let us recall the rudiments of the propagation of monochromatic electromagnetic waves in vacuum. The geometry is characterized by the

⁷The established experimental evidence on electromagnetic waves propagating in certain guides at speeds $c > c_o$ is sufficient, per se, to render equivocal the use of public funds in high energy physics experiments at Fermilab, CERN, and other laboratories all based on the assumption of the exact validity of Einsteinian doctrines within media dramatically denser than *waveguides*, such as the media inside hadrons.

conventional Minkowskian spacetime $M(x, \eta, R)$ with metric, coordinates, wavevector, and related invariants,

$$(\eta_{\mu\nu}) = (\eta^{\mu\nu}) = \text{Diag.}(1, 1, 1, -1), \eta_{\mu\alpha} \times \eta^{\alpha\nu} = \delta_{\mu}^{\nu}, \quad (6.1.38a)$$

$$x = (x^{\mu}) = (r^k, x_4) = (r^i, c_o \times t), K = (K_{\mu}) = (k_i, \frac{\omega}{c_o}), i = 1, 2, 3, \quad (6.1.38b)$$

$$x^2 = (x^{\mu} \times \eta_{\mu\nu} \times x^{\nu}) \times I = (r^i \times r^i - c_o^2 \times t^2) \times I, \quad (6.1.38c)$$

$$K^2 = (K_{\mu} \times \eta^{\mu\nu} \times K_{\nu}) \times I = (k_i \times k_i - \frac{\omega^2}{c_o^2} \times I), \quad (6.1.38d)$$

where, in accordance with our formalism (Section 6.1.2), we multiply the invariants by the unit of the base field R to assure their scalar character on rigorous mathematical grounds, but such a multiplication will be ignored thereafter for notational simplicity.

An elementary electromagnetic wave propagating in empty space can be represented on a conventional Hilbert space \mathcal{H} over C via the familiar wavefunction

$$\psi = e^{i \times K_{\mu} \times x^{\mu}} = e^{i \times k_i \times r^i - \omega \times t}. \quad (6.1.39)$$

We then have the linear momentum eigenvalue equation

$$p_{\mu} \times \psi = -i \times \partial_{\mu} \psi = K_{\mu} \times \psi, \quad (6.1.40)$$

and the well known wave equations

$$\eta^{m\nu\sigma} \times p_{\mu} \times p_{\nu} \times \psi = \eta^{\mu\nu} \times K_{\mu} \times K_{\nu} = (k_i \times k_i - \frac{\omega^2}{c_o^2} \times \psi = 0. \quad (6.1.41)$$

The speed of electromagnetic waves in vacuum can then be represented via the known expressions

$$\frac{dr}{dt} \approx \frac{d\omega}{dk} = c_o, \quad (6.1.42)$$

confirming that c_o is indeed the maximum causal speed *in vacuum*, as well known.

Recall that *isotopies are axiom-preserving*. Hence, the representation of electromagnetic waves of tests [38,39] traveling faster than c_o can be done with *exactly the same expressions* (6.1.38)-(6.1.42), only subjected to a broader realization (or interpretation). Nevertheless, for clarify, we write down the representation explicitly.

The basic space is the Minkowski-Santilli isospace $\hat{M}(\hat{x}, \hat{\eta}, \hat{R})$ [3] with isometric, isocoordinates, isowavevector, and related isoinvariants (see EHM-II, Volume I and the short review in Section 6.1.2)

$$(\hat{\eta}_{\mu\nu}) = (\hat{T}_{\mu}^{\alpha} \times \eta_{\alpha\nu}) = \text{Diag.}(b_1^2, b_2^2, b_3^2, b_4^2),$$

$$(\hat{\eta}^{\mu\nu}) = (\hat{I}_\alpha^\mu \times \eta^{\alpha\nu} = \text{Diag.}(b_1^{-2}, b_2^{-2}, b_3^{-2}, b_4^{-2}), \hat{\eta}_{\mu\rho} \times \hat{\eta}^{\rho\nu} = \delta_\mu^\nu), \quad (6.1.43a)$$

$$\hat{x} = (\hat{x}^\mu) = (\hat{r}^i, \hat{x}_4) = (\hat{r}^i, c_o \times \hat{t}), \hat{K} = (\hat{K}_\mu) = (\hat{k}_i, \frac{\hat{\omega}}{c_o}), \quad (6.1.43b)$$

$$\hat{x}^{\hat{2}} = (\hat{x}^\mu \times \hat{\eta}_{\mu\nu} \times \hat{x}^\nu) \times \hat{I} = (\hat{r}^i \times \hat{r}^i \times b_i^2 - c_o^2 \times \hat{t}^2 \times b_4^2) \times I, \quad (6.1.43c)$$

$$\hat{K}^{\hat{2}} = (\hat{K}_\mu \times \hat{\eta}^{\mu\nu} \times \hat{K}_\nu) \times \hat{I} = (\hat{k}_i \times \hat{k}_i \times b_i^{-2} - \frac{\hat{\omega}^2}{c_o^2} \times b_4^{-2}) \times \hat{I}, \quad (6.1.43d)$$

where the reader should keep in mind that \hat{x} and \hat{K} are now defined on $\hat{M}(\hat{x}, \hat{\eta}, \hat{R})$, and that the speed of light on isospace over isofields is c_o and not $c = c_o \times b_4$ (Volume I and EHM-II).

A monochromatic electromagnetic wave propagating through the guides of the Cologne experiment can be represented on a Hilbert-Santilli isospace \mathcal{H} over the isofield \hat{C} via the elementary isowavefunction (the isoexponentiation (6.1.5f) and EHM-II)

$$\hat{\psi} = e^{i \times \hat{K}_\mu \times \hat{x}^\mu \times b_\mu^2} = e^{i \times \hat{k}_i \times r^i \times b_i^2 - \omega \times t}, \quad (6.1.44)$$

where we have ignored the multiplication by \hat{I} for simplicity.

We then have the *isolinear isomomentum* equation of hadronic mechanics [15]

$$\hat{p}_\mu \hat{\times} \hat{\psi} = \hat{p}_\mu \times \hat{T} \times \hat{\psi} = -i \times \hat{\partial}_\mu \hat{\psi} = \hat{K}_\mu \times \hat{\psi}, \quad (6.1.45)$$

with isowave isoequations

$$\hat{\eta}^{m\nu\omega} \times p_\mu \times p_\nu \times \psi = \eta^{\mu\nu} \times K_\mu \times K_\nu = (k_i \times k_i \times b_i^{-2} - \frac{\omega^2}{c_o^2 \times b_4^{-2}}) \times \psi = 0. \quad (6.1.46)$$

At this point we assume that the space component of the guides of tests [38.39] is isotropic, thus representable with one single space characteristic quantity, and that the symmetry axis of the tests is along the z -axis, thus allowing us to ignore the x and y components,

$$b_1 = b_2 = b_3 = b_s, r^1 = r^2 = k_1 = k_2 = 0. \quad (6.1.47)$$

We also assume that, for the steady conditions here considered, the characteristic quantities are constants or can be averaged into constants.

In correspondence of Eq. (6.1.42) we then have the expression (expressed in terms of conventional differential calculus)

$$\frac{d\hat{r}}{d\hat{t}} \approx \frac{d\hat{\omega}}{d\hat{k}} = c_o \times \frac{b_s}{b_4} = c \times b_s = V_{max}, \quad (6.1.48)$$

namely, *the maximal causal speed of the Cologne experiment is that of isorelativity*, Eq. (6.1.11), thus providing a significant confirmation of the axiomatic structure

of isorelativity. The re-derivation of law 6.1.48) via the isodifferential calculus [15] is an instructive exercise for the reader expert on quantum mechanics, yet with insufficient knowledge of the covering hadronic mechanics.

The simplest possible fit of Eqs. (6.1.48) is given by assuming $b_s = 1$, as a result of which the numerical value of b_4 is trivially given by the numerical data of Refs. [38,39] for c , such as

$$b_4 = \frac{c}{c_o} = 1.5. \quad (6.1.49)$$

However, we note that *a mutation of the geometry of space requires a corresponding mutation of time and vice versa*. Hence, we exclude that we have $b_s = 0$ in the Cologne experiment. Rather than being a drawback, the occurrence renders tests [38,39] quite intriguing. In fact, *depending on the assumed geometry, the Minkowski-Santilli isospace predicts that the Cologne experiment can be conducted for speeds both bigger as well as smaller than that of light in vacuum*, according to the following classification of possibilities:

$$V_{max} > c_o, I : c_o \leq c \leq V_{max}, II : c \leq c_o, \quad (6.1.50a)$$

$$V_{max} = c_o, III : c \leq c_o, \quad (6.1.50b)$$

$$V_{max} < c_o, IV : c \leq V_{max}. \quad (6.1.50c)$$

It appears that the set up of the Cologne experiment has realized only Case I of the above possibilities. The remaining cases are important, e.g., to see whether ordinary particles can travel in between the guides at speeds bigger than $c > c_o$, but smaller than V_{max} . If verified, this occurrence would constitute a superluminal reproduction of the occurrence in water in which electron travel faster than the local speed of light but slower than the maximal causal speed.

We finally mention that the *mutation*⁸ of the geometry caused by the Cologne experiment is conceptually quite simple. Tests [38,39] essentially deal with the interactions at the very foundations of isorelativity and hadronic mechanics, the contact, zero-range interactions that are extended over a volume (thus being nonlocal of integral type) and not representable with a potential (thus being non-Hamiltonian hence requiring nonunitary theories), the latter condition being absolutely crucial to allow speeds $c > c_o$.⁹

⁸"mutations" are referred to invariant alterations of the spacetime geometry referred to isospaces over isofields as first introduced by Santilli [33] in 1967, while "deformations" are referred to non-invariant, thus catastrophically inconsistent alterations of the geometry referred to conventional spaces and fields.

⁹It is easy to prove that for a fully Hamiltonian theory, speeds $c > c_o$ cannot exist. In fact, orthodox physicists still deny speeds $c > c_o$ on grounds that they are not admitted by their beloved theories, a view that is both, correct, yet corrupt because based on the assumption that the old doctrines of the 20-th century, above all Einsteinian theories, are the final doctrines for all of the future history of mankind.

In turn, said non-Hamiltonian interactions cause a mutation in our terminology, namely, they change the very structure of the wavepackets, for instance, by decreasing its amplitude, with consequential decrease of the frequency $\hat{\omega} < \omega$, and increase of the speed $c > c_0$. Once the geometry of the mutation is understood, it should be possible for interested experimentalists to attempt the other cases predicted by isorelativity and hadronic mechanics, Eqs. (6.1.50).

In conclusion, the Cologne experiments [39,40] and their numerous re-runs [40] constitute a direct experimental verification of the ultimate mathematical and physical foundations of isorelativity and relativistic hadronic mechanics with rather deep implications that will better transpire in the following analysis.

10

The serious scholar seriously interested to science should keep in mind that Albert Einstein clearly identified the limits of applicability of special relativity, "point-like particles and electromagnetic waves propagating in vacuum." The extension of the applicability of special relativity beyond the conditions limpidly identified by Einstein has been done by *Einstein's followers* for their personal gains, and not by Einstein.

6.1.8 Experimental Verifications in the Interior of Hadrons

We now study the dynamics within the hyperdense media in the interior of hadrons, nuclei and stars, hereinafter referred as *hadronic media*.

Once the evidence of the inapplicability of special relativity and its underlying Minkowskian geometry is admitted for physical media of low density such as Earth's atmosphere (Figure 6.4), the belief of their exact validity within hadronic media is nonscientific. The selection of the applicable theory is indeed open to scientific debates, by the denial of the need to surpass Einsteinian theories within hadronic media is a scientific manipulation for personal gains. This is due to numerous reasons studied in Volume I, such as:

¹⁰The reader should be made aware of adulterations of the above treatment existing in the literature, such as that by F. Cardone and R. Mignani, Phys. Lett. A **306**, 265 (2003). In fact, this paper: assumes $b_4 = 1$ in which case there cannot be a superluminal speed because one can prove that $c = c_0 \times b_4 = c_0$ via the Lorentz-Santilli isosymmetry and the entire paper makes no sense; conventional differential equations are altered in contradiction with the rigid requirements of the Minkowski-Santilli isogeometry, as proved by the fact that they do not constitute an (axiom-preserving) isotopy; and the paper is catastrophically inconsistent because it deals with a noncanonical - nonunitary formulated via conventional mathematics (Section 6.4). As indicated in an earlier footnote, said authors call the framework "deformed Minkowski space" or "deformed special relativity" and avoid any quotation of the vast preceding literature documentedly known to them (see R. Mignani, Physics Essays **5**, 531 (1992) where the space is called "Santilli isospace"). For these and other reasons, the author filed on February 2007 at the United States Federal Court lawsuit number 8:07-CV-00308-T-23MSS available in the web site of the U. S. Federal Court or in the mirror site <http://www.scientificethics.org/Lawsuit-Cardone-Mignani.htm>

1) The impossibility for photons to propagate for any finite length within hyperdense hadronic media as they propagate in vacuum, with consequential collapse of the entire special relativity, including the impossibility to assume c_o as the maximal causal speed within the media considered;

2) The experimentally established absence within hadrons of a Keplerian structure with a Keplerian center, with consequential well established impossibility for the pillar of special relativity, the Poincaré symmetry, to be exact (Figure 6.1);

3) The inapplicability within hadrons of the mathematics used by special relativity, due to its strict local-differential character, with consequential sole applicability to the nonlocal-integral character of the hadronic structure; and other reasons (see Volume I for details).

The use of conjectures not directly verifiable, such as those based on the hypothetical quarks and neutrinos (see next section), is also a manipulation of science for personal gains when used in their widespread intent: preserve the exact validity of orthodox theories while opposing professional studies on alternative views.

The reader is suggested to meditate a moment on the very large amount of public money that is spent nowadays in particle physics laboratories around the world (estimated in the range of billions of dollars per year) on the assumption that special relativity and the Minkowskian geometry are exact in the interior of the hyperdense hadrons. In this way the reader has a chance of deciding whether to be part of an expected condemnation by posterity, or pursue new physical knowledge.

The epistemological, phenomenological and experimental studies on the impossibility for special relativity and the Minkowskian spacetime to be exact in the interior of hadrons can be summarized as follows. R. M. Santilli [41] submitted the hypothesis in 1982 that *the maximal causal speed in the interior of hadrons is generally bigger than that in vacuum as an intrinsic feature of strong interactions at large.*

The main argument of Ref. [41] is that the maximal possible speed under *action-at-a-distance* interactions is indeed c_o , as well-known and experimentally established, e.g., in particle accelerators. However, under *contact zero-range* interactions, the maximal causal speed can be arbitrary because the energy balance of the latter is dramatically different than that of the former, as classically verified, e.g., in the acceleration of a balloon by Earth's atmosphere.

Strong interactions occur at mutual distances of the order of $1fm = 10^{-13}cm$, that is also the size of all strongly interacting particles. Hence, the activation of strong interactions requires the mutual penetration and overlapping of the wavepackets and/or charge distributions of particles at short mutual distances, with ensuing contact, zero-range, nonpotential interactions. The prediction of Ref. [41] for speeds c bigger than that of light in vacuum, c_o , then applies for strong interactions at large.

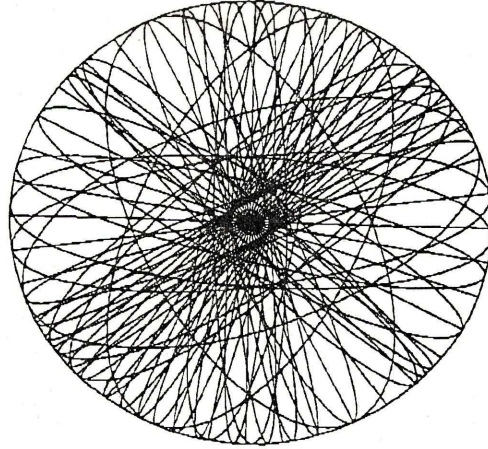

Figure 6.5. A schematic view of the *hadronic medium*, namely, the hyperdense medium inside hadrons, nuclei and stars. When combining the mathematical, theoretical and experimental evidence collected in these volumes, the belief that special relativity and quantum mechanics are "exactly" valid in the interior of hadrons is qualified as a theology without any scientific credibility. In these review lines, it is sufficient to note the impossibility for the Poincaré symmetry to be exact for the interior of hadrons due to the absence of a Keplerian structure and related Keplerian center (Figure 6.1), the impossibility for a photon to propagate in the hyperdense hadronic media in the same way as it propagates in vacuum (Figure 6.4), and numerous other evidence. Of course, when all particles and their wavepackets are abstracted as being points, the hyperdense media in the interior of hadrons disappear, although reappearing via a plethora of directly unverifiable abstractions, conjectures, beliefs and controversies, such as the belief the hadronic constituents are given by the hypothetical undetectable *point-like* quarks without any possible gravity, inertia or confinement (Chapter I.1).

Subsequently, V. de Sabbata and M. Gasperini [42] conducted the first phenomenological verification of the above hypothesis for the interior of hadrons via the use of conventional gauge theories, by obtaining maximal causal speeds up to $c = 75 \times c_0$.

More recently, various astrophysical measurements [43-46] have established the validity of the hypothesis submitted in Ref. [41] (without its quotation), by detecting masses expelled in astrophysical explosions (thus under contact interactions) at speeds $c \gg c_0$.

An additional verification of the validity of the Minkowski-Santilli isospace for the geometrization of media inside hadrons was provided in 1992 by H. B. Nielsen and I. Picek [47] [of the Niels Bohr Institute in Copenhagen, Denmark, who conducted extensive phenomenological calculations via conventional gauge

theories in the Higgs sector, and derived the following isometrics for the interior of pions and kaons,

$$\begin{aligned} \hat{\eta} &= \text{Diag}[(1 - \alpha/3), (1 - \alpha/3), (1 - \alpha/3), -c_o \times (1 - \alpha)] \equiv \\ &\equiv \text{Diag}(b_1^2, b_2^2, b_3^2, b_3^2, -c_o \times b_4^2) = \text{Diag}(1/n_1^2, 1/n_2^2, n_3^2, -c_o^2/n_4^2), \end{aligned} \quad (6.1.51)$$

with numerical values for *pions*

$$b_1^2 = b_2^2 = b_3^2 = 1 + 1.2 \times 10^{-3}, \quad b_4^2 = 1 - 3.79 \times 10^{-3}, \quad (6.1.52)$$

and for *kaons*

$$b_1^2 = b_2^2 = b_3^2 = 1 - 2 \times 10^{-4}, \quad b_4^2 = 1 + 6.1 \times 10^{-4}. \quad (6.1.53)$$

As one can see, the phenomenological studies by Nielsen and Picek [47] provide a direct verification of isorelativity and relativistic hadronic mechanics, including the hypothesis [41] of speeds $c > c_o$.¹¹

In fact, for pions we have $b_4 < 1$ and, consequently, speeds $c < c_o$, whereas for kaons we have $b_4 > 1$ and, therefore, $c > c_o$. Since the *charge radius* of all hadron is approximately the same, 1fm , *the density of hadrons increases with mass*. Consequently, speeds $c > c_o$ are expected to persist for all heavier hadrons, as confirmed by subsequent data reviewed in the next sections.

The inapplicability of the conventional notions of spacetime for metrics (6.1.52)-(6.1.53), with consequential inapplicability of special relativity, are evident. The direct universality of the Minkowski-Santilli isospace and related isorelativity should equally be noted.

Intriguingly, the Minkowski-Santilli isospace requires that in the interior of hadrons we have an alteration of both space and time. Recall that the characteristic quantities characterize the isounit of the theory, Eq. (6.1.5b). Hence, from data (6.1.52), we have for pions

$$\begin{aligned} \hat{I}_{pions} &= \text{Diag}(1/1.0012, 1/1.0012, 1/1.0012, 1/0.9963) = \\ &= \text{Diag}(0.9988, 0.9988, 0.9988, 1.0037), \end{aligned} \quad (6.1.54)$$

namely, the space isounit is smaller than 1 and the time isounit is bigger than 1. Consequently, *pions are iso-minkowskian media of Group II, Type5* (Figure 6.3).

¹¹The author attempted a number of times to contact H. B. Nielsen and I. Picek at the Niels Bohr Institute in Copenhagen, to discuss the implications of their paper [47] with no replay, expectedly because such implications are in manifest conflict with organized interests on Einsteinian doctrines. The author subsequently received information that H. B. Nielsen and I. Picek had been under pressure by orthodox interests to renounce or dismiss the results of paper [47]. The Niels Bohr Institute is suggested to implement corrective measures and conduct indeed systematic studies on the inapplicability of orthodox doctrines within hadronic media so as to avoid problems of scientific ethics and accountability particularly for use of public funds.

For kaons we have the isounit

$$\begin{aligned} \hat{I}_{kaons} &= \text{Diag.}(1/0.9998, 1/0.9998, 1/0.0008, 1/1.0004) = \\ &= \text{Diag.}(1.0002, 1.0002, 1.0002, 0.9996), \end{aligned} \tag{6.1.55}$$

namely, the space isounit is bigger than 1 and the time isounit is now smaller than 1. Consequently, *pions are iso-Minkowskian media of Group III, Type 9* (Figure 6.3).

The fundamental invariant is given by

$$x^2 = [\text{length}]^2 \times [\text{unit}]^2. \tag{6.1.56}$$

Consequently, data (6.1.52), (6.1.53) indicate that *in the interior of pion we have an isodilation of length of the order of*

$$\hat{\ell}^2 \approx .1.0012 \times \ell^2 \tag{6.1.57}$$

and an isocontraction of time of the order of

$$\hat{t}^2 \approx 0.9963 \times t^2 \tag{6.1.58}$$

while in the interior of pions we have an isocontraction of length of the order of

$$\hat{\ell} \approx 0.9998 \times \ell \tag{6.1.59}$$

and an isodilation of time of the order of

$$\hat{t} \approx 1.0004 \times t \tag{6.1.60}$$

This is a fundamental novel implication of Santilli isorelativity with vast implications at the epistemological, theoretical and experimental levels, where the novelty is given by the prediction that space and time are altered by matter as a physical medium without a direct gravitational consideration.¹²

Note that the above isodilations and isocontractions imply corresponding versions for the remaining isoactions. For instance, Isoaction V, Eq. (6.1.15) we have

$$\begin{aligned} E_{pions} &= m \times V_{max} = m \times c_o \frac{b_4^2}{b_3^2} = m \times \frac{1.0037}{0.9998} = \\ &= 1.0004 \times m \times c_o^2, \end{aligned} \tag{6.1.61a}$$

¹²The reader should remember that the characteristic quantities do have a connection with gravitation since departures from the Minkowski metric can be interpreted as being of Riemannian character n (Section 6.1.2). However, even under such an interpretation, the prediction of alteration of space and time by isorelativity remains new, in the sense of being beyond general relativity.

$$m_{pions} = 0.9961 \times \frac{E_{pions}}{c_o^2}, \quad (6.1.61b)$$

and for kaons we have

$$\begin{aligned} E_{kaons} &= m \times V_{max} = m \times c_o \frac{b_4^2}{b_3^2} = m \times \frac{0.9998}{1.0002} = \\ &= 0.9996 m \times c_o^2, \end{aligned} \quad (6.12.62a)$$

$$m_{kaons} = 1.0012 \times \frac{E_{pions}}{c_o^2} \quad (6.1.62b)$$

namely, *isorelativity predicts that the inertial mass of pions is smaller than that predicted by special relativity, while the inertial mass of kaons is bigger.* This prediction too has far reaching implications, such as the possibility of eliminating the need for the conjecture of *dark matter*, as we shall see later on in this section. The reader is encouraged to work out the remaining isoaxioms for data (6.1.61), (6.1.62).

Note that *features (6.1.61) are a consequence of the medium being of Group II, Type 5, and features (6.1.62) are a consequence of the medium being of Group III, Type 9.* This illustrates the profound dynamical implications of physical media when deviating from the homogeneity and isotropy of the Minkowskian spacetime.

It should be indicated that *particles traveling in interior conditions faster than the local speed of light are not tachyons, or isotachyons, but ordinary tardyons or isotardyons.* In fact, electrons traveling in water faster than the local speed of light are ordinary particles and cannot possibly be tachyons just because the speed of light is decreased. Similarly, particles traveling in the interior of kaons faster than the speed of light in vacuum, but slower than the internal maximal causal speed, are isotardyons and not tachyons or isotachyons..

In order to have true tachyons, a particle must be an isotachyon, namely, it should travel at speeds bigger than the maximal causal speed V_{max} . To the author's best knowledge, at this writing there is large experimental evidence of massive particles traveling at speeds bigger than the local speed of light, but there is no experimental evidence of true tachyons, namely, particles traveling faster than the local maximal causal speed.

6.1.9 Experimental Verifications with the Behavior of the Meanlives of Unstable Hadrons with Speed

The hyperdense character of the medium inside hadrons has been known since the discovery of protons and neutrons, and the measurement of their mass and size. In turn, dynamics within hyperdense media lead to the historical open

legacy that strong interactions have a nonlocal component due to deep wave-overlappings, namely, a condition that renders special relativity inapplicable beginning from its topology, let alone the inability to represent zero-range contact interactions extended over a volume.

Strong interactions have a range of 10fm that is essentially the size of all hadrons. It then follows that, unlike electromagnetic interactions, *a necessary condition to activate strong interactions is that hadrons enter into conditions of deep mutual overlappings* [14]. The nonlocal-integral condition of strong interactions is then beyond scientific doubt and so is the inapplicability of special relativity.

Also, to be physical, the hadronic constituents must have wavepackets of the order of the entire hadrons. This implies that, unlike the atomic constituents, *the hadronic constituents are in condition of total mutual penetration of their wavepackets, each one completely inside all others*, thus resulting, again, in a nonlocal-integral structure beyond any credible representation capability by special relativity.

The above view *is not* in contrast with the experimental evidence that hadrons in a particle accelerator do indeed follow the laws of special relativity, because, in the high vacuum of a particle accelerator, hadrons are well approximated as being point-like particles under action-at-a-distance electromagnetic interactions, as necessary for the applicability of special relativity.

Hence, we have a dichotomy given by the exact applicability of special relativity for the center of mass behavior of hadrons in vacuum, and deviations from special relativity expected in the interior of hadrons, which dichotomy requires an experimental resolution.

Hence, the issue here addressed deals with *experimental means to detect from the outside deviations from special relativity expected in the interior of hadrons*. The answer to this question is known and it is given by *expected deviations from the prediction of special relativity on the behavior of the meanlives of unstable hadrons with speed* (or energy), i.e., deviations from the well known Einsteinian decay law

$$t = t_o \times \left(1 - \frac{v_k \times v_k}{c_o \times c_o}\right)^{-1/2}. \quad (6.1.63)$$

To the authors' best knowledge, the first studies on deviations from special relativity caused by nonlocal internal effects in the structure of hadrons were conducted in 1964 by D. L. Blokhintsev and his group [48] of the JINR in Dubna, Russia. The studies were continued by L. B. Redei [49] in Italy, D. Y. Kim [50] in Canada, and others.

A rather unsettling feature of these studies was that they proposed different generalizations of the Einsteinian law (6.1.63), thus creating the problem of which law to test.

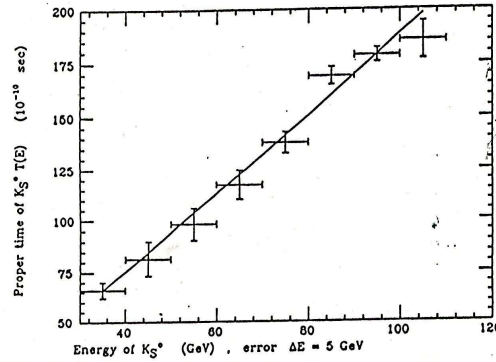

Figure 6.6. A first evidence of deviation from Einstein decay law in the meanlives of unstable hadrons is given by the linear fit of the experimental data on the K_S^0 lifetime via law (6.1.63) conducted by Cardone et al [55]. The fit resulted in the value of the lifetime at rest $\tau = (0.9375 \pm 0.0021) \times 10^{-10}$ s compared to the experimental value also at rest $\tau_o = (0.8922 \pm 0.0020) \times 10^{-10}$ s with a confidence level 0.39 giving a probability of 61 % that the constant value at rest τ_o is greater than the actual value, namely, nonlocal internal effects are expected to decrease the value of the meanlife with speed. As we shall see, this behavior is connected to the increase of the proper time of the hadron considered compared to the proper time of an external observer. Not computed in Ref. [55] are corresponding deviations of the size of hadrons that is equally expected to deviate from Einsteinian contraction law. The reader should keep in mind that these mutations of space and time are the experimental foundation of the *isogeometric locomotion* of Chapter 13, namely, locomotion based on the control of distances via isogeometric mutations of space and time, without any Newtonian action and reaction.

In 1983 R. M. Santilli [3] proposed the iso-Minkowskian spaces $\hat{M}(\hat{x}, \hat{\eta}, \hat{R})$ with *isotime dilation* as in Isoaxiom III, Eqs. (6.1.13a),

$$t = t_o \times \left(1 - \frac{v_k \times b_k^2 \times v_k}{c_o \times b_4^2 \times c_o}\right)^{-1/2} = t_o \times \left(1 - \frac{(v_k \times v_k/n_k^2)}{(c_o \times c_o/n_4^2)}\right)^{-1/2} \quad (6.1.64)$$

A. K. Aringazin [51] from Kazakhstan proved that the Santilli's decay isolaw is *directly universal* for all possible (signature preserving) modifications of the Minkowskian law (6.1.63) (as expected from the direct universality of isorelativity), since all generalized decay laws can be obtained as particular cases of isolaw (6.1.64) via different expansions in terms of different coefficients subjected to different truncations. Aringazin's important result is that, rather than testing a variety of seemingly different laws, the experiments can be solely conducted for isolaw (6.1.64).

The first direct experimental measurement of the behavior of the meanlife of the unstable K_o s with energy was conducted in 1983 by S. H. Aronson et al. [52]

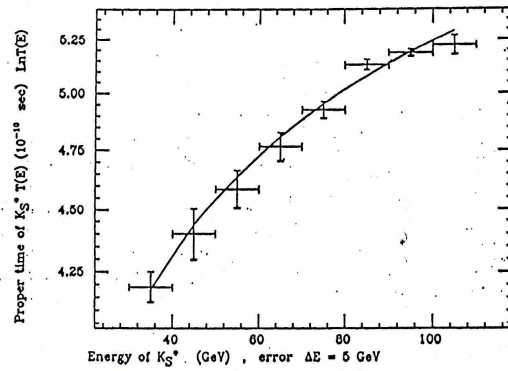

Figure 6.7. The exact fit of Santilli’s iso-Minkowskian law (6.1.64) [3] provided by Cardone et al. [55] on the data of Fermilab experiment [52] from 30 to 100 GeV providing a second experimental confirmation of deviations from the Einsteinian decay law.

at Fermilab suggesting *clear deviations from the Einsteinian decay law (6.1.63) in the different energy range from 30 GeV to 100 GeV.*

Following the appearance of results [52], additional direct experimental measurements were conducted in 1987 by N. Grossman et al. [53] also at Fermilab, which tests showed *apparent verification of the Einsteinian law (6.1.45), although in the different energy range from 100 to 400 GeV.*

Additionally, a test of the decay law at short decay times was made by G. Alexander et al. at LEP [54], in which the events $Z^0 \rightarrow \tau^+ + \tau^-$ show a *clear deviation from the conventional law of the order of 1.1 %.*

In paper [55] of 1992, F. Cardone (then of the First University in Rome, Italy) et al. proved that the Minkowski-Santilli isospace permits an exact fit of experimental data [52] (see Figure 6.6).

In the subsequent paper [56], F. Cardone et al. proved that the same Minkowski-Santilli isorepresentation unifies the seemingly discordant results of tests [52] and [53] (Figure 6.7).

In this way, Cardone et al. achieved the following numerical values of the characteristic quantities for the K^0 s

$$b_1^2 = b_2^2 = b_3^2 = 0.989080 \pm 0.0004, b_4^2 = 1.002 \pm 0.0007. \tag{6.1.65a}$$

$$\Delta b_k^2 = 0.007, \quad \Delta b_4^2 = 0.001. \tag{6.1.65b}$$

It is evident that the above fits constitute another experimental verification on the validity within kaons of Santilli isorelativity [3], the underlying Minkowski-Santilli isogeometry [10], and relativistic hadronic mechanics [16].

A most important feature of experimental data (6.1.65) is that they provide an *independent confirmation of the iso-Minkowskian character of the medium within*

kaons reached in the preceding section with different procedures as being of Group III, Type 9 (Figure 6.3). Due to the general dominance of geometry over dynamics, the above independent confirmation of the iso-Minkowskian character of the medium inside kaons is the most important result of this section.

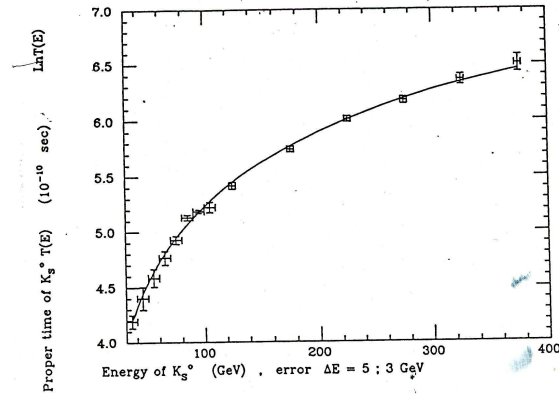

Figure 6.8. The exact fit of Santilli's iso-Minkowskian law (6.1.64) [3] provided by Cardone et al. [56] on the data of Fermilab experiment [52,53] from 30 to 400 GeV providing a third experimental confirmation of deviations from the Einsteinian decay law.

Somme of the consequences of Refs. [55,56] are the following:

1) The fits of Figure 6.6 confirm in an independent way that the maximal causal speeds in the interior of kaons is bigger than that in vacuum. In fact, values (6.1.65a) are very close to values (6.1.54) even though derived in different ways (the former via direct measurements and the latter via phenomenological calculations).

2) Results (6.1.65) confirm that the quantity $b_4 = 1/n_4$ provides a geometrization of the density of the hadron considered (again, normalized to the value $b_4 = 1/n_4 = 1$ for the vacuum), while the dependence of the characteristic quantities on the speed (or energy) is essentially in the space components $b_k = 1/n_k$,] $k = 1, 2, 3$ (also normalized to the values $b_k 1/n_k = 1, k = 1, 2, 3$ for the vacuum).

3) Results (6.1.65) void the measurements by Grossman et al. [53] of any conclusive value, evidently because we have experimental deviations from the Minkowskian geometry even under the assumption that tests [53] are valid.

4) Results (6.1.65) establish that the rest energy of the constituents of hadrons is not given by the familiar expression $E = m \times c_o^2$, but rather by the isorenormalized Eq. (6.1.15), i.e.

$$E = m \times V_{max}^2 = m \times c_o^2 \times \frac{b_4^2}{b_3^2} = m \times c_o^2 \times \frac{n_3^2}{n_4^2}. \quad (6.1.66)$$

Since the rest energies of the particles are well known, the above isoaxiom implies that *the masses (or inertia) of the kaons are smaller than what generally assumed until now..*

5) Results (6.1.65) establish that the frequency $\hat{\nu}$ of photons (or gluons ?) emitted in the interior of hadrons is not characterized by the traditional law $\nu = E/h$, but instead by the isorenormalized law

$$\hat{\nu} = \nu \times \frac{b_4^2}{b_3^2} = \nu \times \frac{n_3^2}{n_4^2}, \quad (6.1.67)$$

with *isoredshift* (tendency toward the red) within the physical media inside pions and *isoblueshift* (tendency toward the blue) for kaons and all other hadrons.

6) Said results establish that light emitted in the interior of hadrons is also isoredshifted or isoblueshifted, that is, it reaches the outside at a frequency smaller or bigger than that originally emitted in the interior because of mechanisms of the isospecial relativity studied later on in astrophysical verifications (essentially due to release or absorption of energy from the medium).

7) Said results establish that in the interior of kaons and all other heavier hadrons, space is contracted in the geometric sense that the Euyclidean distance becomes smaller and time flows faster than the correspponmding quantities in the exterior. In fact, the basic units of space and time are characterized by experimental fits (6.1.65) and are given by

$$\hat{I} = (\hat{I}_{space}, \hat{I}_{time}), \quad (6.1.68a)$$

$$\hat{I}_{space} = Diag.(1.001.1.001.1.001), \quad \hat{I}_{time} = 0.9980. \quad (6.1.68b)$$

Since spacetime invariants have the structure (Sections I.3.5)

$$Invariant = (Length)^2 \times (Unit)^2 \quad (6.1.69)$$

it is evident that the increase (decrease) of a unit causes the decrease (increase) of the related length.

As an incidental note, the above features have stimulated the formulation of the so-called geometrical propulsion studied in CChapter 13, in which objects can move following a local directional change of the geometry without the application of any force visible to the outside, thus permitting, on mathematical grounds, arbitrary speeds for an outside observer.

Remarkably, features 1) to 7) are verified by all subsequent experiments, as we shall see.

A few comments are now in order. We should first indicate that the measurements by Grossman et al. [53] have been the subject of rather severe criticisms. First of all, the experimenters have made the theoretical assumption in the data elaboration of a frame in which there is no CP violation, in which case it is known

that there cannot be Minkowskian anomalies, as shown by D. Y. Kim [50] and others. Moreover, the statistics of tests [53] are insufficient for any conclusion whether in favor or against orthodox doctrines. Additional flaws of tests [53] have been identified by Yu. Arestov et al. [57]. These limitations are discussed in detail in Appendix 6.D.

I would like also to stress that the deviations from the Minkowskian geometry do not constitute a violation of the fundamental Lorentz symmetry. This is due to the fact that the isotopies reconstruct the Lorentz symmetry as being exact in iso-Minkowskian space, as studied in Volume I. This feature is important to disprove claims, such as that by H. B. Nielsen and I. Picek that their parameter characterizes a "violation of the Lorentz symmetry" [47]. Such a statement is a mere consequence of the use for the interior of hadrons mathematics solely applicable for the exterior problem in vacuum because, when the appropriate mathematics is adopted, the Lorentz symmetry remains fully valid for deformation of the spacetime of type (6.1.51).

Note, however, that the Lorentz symmetry is preserved exactly at the abstract, realization free level for the nonlocal internal effects here considered. However, this is not the fate of special relativity since experimental evidence requires structural departures, such as the impossibility of assuming the speed of light in vacuum or inside hadrons as the maximal causal speed in the interior of the hyperdense hadrons and other deviations represented by the Isoaxioms I-V.

The reader should be aware that the exact fits of Figures 2 and 3 were simply unavoidable, due to the direct universality of Santilli's iso-Minkowskian geometry for the representation of all infinitely possible, signature preserving deviations from the Minkowskian form. ¹³

6.1.10 Experimental Verifications via the Bose-Einstein Correlation

6.1.10.A The Unavoidable Nonlocal and Non-Hamiltonian character of the Correlation

The fundamental assumption of hadronic mechanics is that strong interactions have a nonlocal component of contact, thus nonpotential type due to deep wave-overlappings at mutual distances of 1 Fermi, which component has to be represented with anything except the Hamiltonian (to prevent granting potential energy to interactions that have none, a rather common trend in the physics of the 20-th century).

¹³We should indicate the existence in the literature of several other "deformations" of the Minkowski spacetime stimulated by the isotopies [3], such as those of Refs. [58] and papers quoted therein. These deformations are formulated over conventional fields, rather than on isofields, and, as such, they verify the Theorems of catastrophic Inconsistencies of Section 6.6.

The most fundamental experimental verifications of hadronic mechanics are, therefore, those testing directly the expected nonlocality of the strong interactions. Among them, the most important tests are those on the Bose-Einstein correlation (see, e.g., Refs. [59-62]) in which:

(i) Protons and antiprotons are made to collide at very big or very small energies;

(ii) In so doing, protons and antiprotons annihilate each other in a region called the *fireball*; and

(iii) The annihilation produces various unstable hadrons whose final states are given by correlated mesons (i.e., very loosely speaking, mesons which are "in phase" with each other despite large mutual distances compared to the size of the fireball).

It is well-known in the literature that the Bose-Einstein correlation cannot be admitted by purely local theories, that is, theories dealing with a finite set of isolated point-like particles. Hence, by conception and technical realization, *the Bose-Einstein correlation is a nonlocal event*.

At this point, numerous "nonlocal theories" have been constructed for the pre-set intent of adapting physical reality to Einsteinian theories. These theories are essentially based on the attempt of reducing a nonlocal event (distributed over the finite volume of the fireball) to a finite number of isolated points, said reduction being mandatory for the applicability of the mathematics underlying Einsteinian theories, let alone their physical laws.

Since the reduction of a finite volume to a set of isolated points is a figment of academic imagination dramatically disjoint from physical reality, these "nonlocal theories" are hereon ignored.

Equally known by experts (as the author can testify), and as shown in detail below, is the fact that *the Bose-Einstein correlation is incompatible with the axiom of expectation values of quantum mechanics, thus mandating the use of a covering theory, irrespective of whether nonlocal interactions can be manipulated to verify quantum laws*.

The first exact and invariant formulation of the Bose-Einstein correlation via relativistic hadronic mechanics was done by R. M. Santilli in memoir [63] of 1962. The first of the experimental data was done by F. Cardone and R. Mignani (then at the University La Sapienza, in Rome, Italy) and provided to Santilli as a private communication. Subsequently, F. Cardone and R. Mignani provided their version of the isorelativistic treatment in paper [64] of 1996. A number of additional papers were subsequently published (such as Ref. [65]) although without structural advances.¹⁴

¹⁴It should be noted that Ref. [64] was properly written with the quotation of all originating papers and the identification of the full paternity of the various theories by Santilli. It was unfortunate that the authors subsequently elected to write a series of papers (such as those accepted by Cornell University

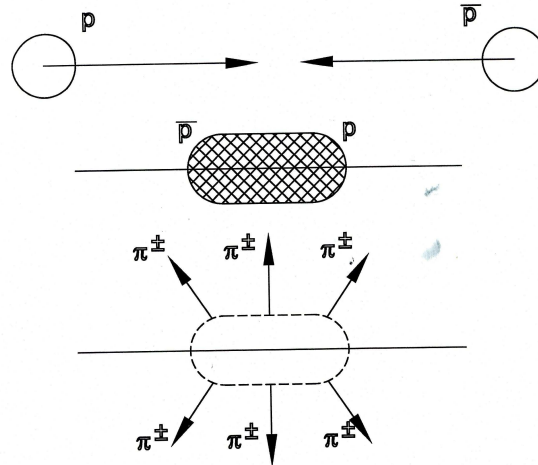

Figure 6.9. A conceptual view of the Bose-Einstein correlation in which: protons and antiprotons collide at extremely high energies; coalesce one into the other resulting into the so-called fireball (that is one of the densest media measured by mankind in laboratory until now); annihilate each other; and then result in the production of unstable particles whose final result is a large number of mesons that remain correlated at distances very large compared to the size of the fireball. Without doubt, the Bose-Einstein correlation has seen the biggest scientific obscurantism in the 20-th century physics because treated under the claim that Einstein special relativity and relativistic quantum mechanics are exactly valid, while it has been known for decades that the arbitrary parameters needed for the fit of the experimental data (called "chaoticity parameters") are prohibited by the basic axioms of relativistic quantum mechanics, such as that for the vacuum expectation values (see the text). By comparison, relativistic hadronic mechanics allows an exact representation of the experimental data of the Bose-Einstein correlation while restoring the exact validity of the Lorentz and Poincaré symmetries under non-local and non-Hamiltonian internal effects. This episode raises the questions to be answered by the individual reader: Why do, a decreasing minority of seemingly qualified scientists continue to prefer the manipulations of the former treatment against the exact and invariant treatment of the covering theory?

In this section we shall follow the original derivation of memoir [63] due to departures from the rigorous use of relativistic hadronic mechanics of paper [64] identified below. The reader should be aware that, to avoid an excessive length, a study of the original memoir [63] is necessary for a technical knowledge of the field.

arxiv) without any quotation whatever of Santillis originating papers. The lack of any corrective measures by both the authors and Cornell University then mandated the filing of legal action at the U./ S. federal Court one can inspect in the mirror web site <http://www.scientificethics.org>

6.1.10.B Conventional treatment of the Bose-Einstein correlation

We now outline the conventional treatment of the Bose-Einstein correlation via relativistic quantum mechanics by following review [59].

Consider a quantum system in 2-dimensions represented on a Hilbert space \mathcal{H} with initial and final states $|a_k \rangle$, $|b_k \rangle$, $k = 1, 2$. The *vacuum expectation values* of an observable A are given

$$\langle A \rangle = \langle a_k | \times A \times | b_k \rangle = \sum_{k=1,2} a_k \times A_{kk} \times b_k, \tag{6.1.70}$$

which is *necessarily diagonal*, trivially, because a necessary condition for a quantity to be observable is that of being Hermitean.

The *two-points correlation function* of the Bose-Einstein correlation is defined by

$$C_2 = \frac{P(p_1, p_2)}{P(p_1) \times P(p_2)} \tag{6.1.71}$$

where $P(p_1, p_2)$ is the *two particles probability density* subjected to Bose-Einstein symmetrization, and $P(p_k)$, $k = 1, 2$, is the corresponding quantity for the k particle with 4-momentum p_k .

The two-particles density is routinely computed via the vacuum expectation value

$$\begin{aligned} P(p_1, p_2) &= \\ &= \int \psi_{12}^\dagger(x_1, x_2; r_1, r_2) \times \psi_{12}(x_1, x_2; r_1, r_2) \times F(r_1) \times F(r_2) \times d^4 r_1 \times d^4 r_2, \end{aligned} \tag{6.1.72}$$

where ψ_{12} is the *probability amplitude* to produce two bosons at r_1 and r_2 that are detected at x_1 and x_2 ,

$$\begin{aligned} \psi_{12} &= \frac{1}{\sqrt{2}} \times \\ &\times (e^{i \times p_1 \times (x_1 - r_1)} \times e^{i \times p_2 \times (x_2 - r_2)} + e^{i \times p_1 \times (x_1 - p_2)} \times e^{i \times p_2 \times (x_2 - r_1)}). \end{aligned} \tag{6.1.73}$$

Various steps (we suggest the reader to inspect in Ref. [59]) then lead to the the Gaussian form of the densities

$$F_k = \frac{1}{4 \times \pi^2 \times R^4} \times \exp\left(-\frac{r^2}{2 \times R^2}\right), \quad k = 1, 2, \tag{6.1.74}$$

where R is the Gaussian width and r is generally assumed to be the radius of the fireball.

Via the use of standard procedures, one reach in this way the final expression for the two-point correlation function

$$C_2 = 1 + e^{-Q_{12}^2 \times R^2}, \tag{6.1.75}$$

where $Q_{12} = p_1 - p_2$ is the *momentum transfer*.

6.1.10.C Incompatibility of the Bose-Einstein correlation with Relativistic Quantum Mechanics

It is well known that the above treatment of the Bose-Einstein correlation deviates substantially from experimental data. This led to the introduction of a first, completely unknown parameter λ , called "chaoticity parameter" and the *ad hoc* modification of law (6.1.75)

$$C_2 = 1 + \lambda \times e^{-Q_{12}^2 \times R^2}. \quad (6.1.76)$$

Note that it is impossible to derive the above parameter from any axiom of relativistic quantum mechanics. Hence, *on serious scientific grounds, the chaoticity parameter λ is the first direct evidence of the incompatibility of the Bose-Einstein correlation with quantum axioms.*

It soon turned out that adulterated expression (6.1.76) too deviates dramatically from experimental data. The problem was quickly "solved" in the conventional fashion of the 20-th century physics, via the introduction of an increasing number of completely unknown and arbitrary parameters until the desired fit of the experimental data was achieved and then declare quantum mechanics to be exactly valid in the field.

This "solution" led to the necessary introduction of *four completely arbitrary chaoticity parameters* and adulterated expressions of the type

$$C_2 = 1 + \lambda_1 \times e^{-Q_{12}^2 \times R^2} + \lambda_2 \times e^{-Q_{12}^2 \times R^2} + \lambda_3 \times e^{-Q_{12}^2 \times R^2} + \lambda_4 \times e^{-Q_{12}^2 \times R^2}, \quad (6.1.77)$$

that did eventually reach some compatibility with experimental data [59].

However, *the only scientific (that is, rigorous) way of achieving the additional terms in Eq. (6.1.77) is that via a nondiagonal formulation of the expectation values. The latter are prohibited by relativistic quantum mechanics for observable quantities as in Eq. (6.1.70).*

This establishes beyond scientific or otherwise credible doubt that *the chaoticity parameters are a direct measure of the deviation of the Bose-Einstein correlation from experimental evidence.*

Independently from that, relativistic quantum mechanics has the following insufficiencies for a serious study of the Bose-Einstein correlation:

(1) The theory can only represent the proton and the antiprotons as dimensionless points. The very existence of the fireball, let alone of the ensuring correlation, is then in question.

(ii) The above point-like abstraction of particles has a number of technical consequences, such as the factorization of the densities in Eq. (6.1.72) that, *per se*, is sufficient to prohibit correlation, as shown below;

(iii) Relativistic quantum mechanics must assume the fireball to be necessarily spherical, so as to prevent the loss of one of its central pillars, the rotational

symmetry, which feature alone is sufficient to warrant a covering theory irrespective of all other aspects, due to the dominance of spacetime symmetries over calculations.

6.1.10.D Representation of the Bose-Einstein correlation via relativistic hadronic mechanics

By falloring the first original derivation [63], we first recall that, unlike expression (6.1.70), the axiom of *isoexpectation value* for relativistic hadronic mechanics is given by

$$\langle \hat{A} \rangle \langle \hat{a}_k | \times \hat{T} \times \hat{A} \times \hat{T} \times | \hat{b}_k \rangle = \Sigma_{ijk=1,2} \hat{a}_i \times \hat{T}_i^j \times \hat{A}_{jj} \times \hat{T}_j^k \times \hat{b}_k, \quad (6.1.78)$$

where \hat{T} is the isotopic element, and the "hat" denotes quantities defined on isospaces over isofields.

The main new feature is that the operator \hat{A} must be Hermitean, thus diagonal, to be observable,¹⁵ but the isotopic element does not need to be diagonal.

Santilli main contributions in memoir [63] are the proof that:

(i) *The Bose-Einstein correlation is incompatible with the axioms of relativistic quantum mechanics because of the impossibility to admit off-diagonal terms in the two-point correlation function from unadulterated first principles, and otehr reasons;* and

ii *The Bose-Einstein correlation is directly compatible with the axioms of the covering relativistic hadronic mechanics because of the admission of nonlocal non-Hamiltonian interactions and the appearance of off-diagonal terms from first principles.*

The rest is given by a mere application of relativistic hadronic mechanics. We assume at the foundation of the treatment Santilli isorelativity with Minkowski-Santilli isospace $\hat{M}(\hat{x}, \hat{\eta}, \hat{R})$, isoinvariant, isometric, isotopic element and isounit given respectively by [3]

$$\hat{x}^{\hat{2}} = (\hat{x}^{\mu} \hat{\times} \hat{\eta}_{\mu\nu} \hat{\times} \hat{x}^{\nu}) \times \hat{I} = [x^{\mu} \times (\hat{T}_{\mu}^{\nu} \times \eta_{\nu\rho}) \times x^{\rho}] \times \hat{I} \in \hat{R}, \quad (6.1.79a)$$

$$\hat{\eta} = \text{Diag.}(b_1^2, b_2^2, b_3^2, -b_4^2) \times \Gamma = \text{Diag.}(1/n_1^2, 1/n_2^2, 1/n_3^2, -1/n_4^2) \times \Gamma, \quad (6.1.79b)$$

$$\hat{T} = \text{Diag.}(b_1^2, b_2^2, b_3^2, b_4^2) \times \Gamma = \text{Diag.}(1/n_1^2, 1/n_2^2, 1/n_3^2, 1/n_4^2) \times \Gamma, \quad (6.1.79c)$$

$$\hat{I} = \text{Diag.}(1/b_1^2, 1/b_2^2, 1/b_3^2, 1/b_4^2) \times \Gamma^{-1} = \text{Diag.}(n_1^2, n_2^2, n_3^2, n_4^2) \times \Gamma^{-1}, \quad (6.1.79d)$$

$$b_{\mu} = b_{\mu}(t, x, p, E, \dots) > 0, n_{\mu} = n_{\mu}(t, x, p, E, \dots) > 0, \quad (6.1.79e)$$

$$\hat{T} = \hat{T}(t, x, p, E, \dots), \quad \hat{I} = \hat{I}(t, x, p, E, \dots) = 1/\hat{T}, \quad (6.1.79f)$$

¹⁵Recall from Chapter I.3 that *iso-Hermiticity coincides with conventional Hermiticity*. Hence, all quantities that are observable for quantum mechanics remain observable for hadronic mechanics.

where: isoinvariant (6.1.79a) must be an element of the isofield \hat{R} and, consequently, must have the structure of $\hat{x}^2 = n \times \hat{I}$, where n is a real number; the spacetime isocoordinates must also be elements of the isofield, thus have the form $\hat{x} = x \times \hat{I}$, $x = (x^\mu)$, $\mu = 1, 2, 3, 4$; isoproducts of the isocoordinates with a generic quantity Q can be reduced for simplicity to ordinary products, $\hat{x} \hat{\times} Q = (x \times \hat{I}) \hat{T} \times Q = x \times Q$ as done in isoinvariant (6.1.79a); we continue to use both notations for the characteristic quantities, $b_\mu = 1/n_\mu$ following their original formulation in [3,63] because handy in various applications; the quantity Γ is a 2×2 -matrix to be identified shortly; and one should keep in mind the explicit dependence of the characteristic quantities in time t , coordinates x , momenta p , energy E and any need additional quantity.¹⁶

It should be stressed that *the characteristic quantities must represent physically measurable quantities, namely, $1/b_k^2 = n_k^2$, $k = 1, 2, 3$, must characterize the semiaxes of the Bose-Einstein fireball according to a proper normalization (see below), and $1/b_4^2 = n_4^2$ must characterize the density of the fireball in a way compatible with other experiments.*

To state this crucial point explicitly, the chaoticity parameters λ_μ , $\mu = 1, 2, 3, 4$ are completely arbitrary and without any possible physical meaning. By contrast, the characteristic quantities $1/b_\mu^2 = n_\mu^2$ must represent concrete physical features that with experimentally verifiable numerical values as a condition for the isorepresentation to be consistent.

As a concrete illustration, in the event the fit of the experimental data yields values of the type $b_1^2 = b_2^2 = b_3^2$, the emerging isorepresentation would be inconsistent because the Bose-Einstein fireball cannot possibly be a sphere due to the extreme energies of the collision. As a result, said fireball must be a very elongated spheroidal ellipsoid, for instance, of the type $b_3^2 \gg b_1^2 = b_2^2$.

As an additional and independent condition for consistency, the numerical value of the density $b_4^2 = 1/n_4^2$ must be compatible with numerical values from different experiments on comparable densities, such as those for protons and neutrons.¹⁷

By continuing to follow the original derivation [63], we now represent the correlation on an iso-Hilbert space $\hat{\mathcal{H}}$ with initial and final isostates $|\hat{a}_k\rangle$, $|\hat{b}_k\rangle$, $k = 1, 2$, and the non-diagonal isotopic element (6.1.79c) in the explicit form

$$\hat{T} = \text{Diag.}(b_1^2, b_2^2, b_3^2, b_4^2) \times \Gamma = \text{Diag.}(1/n_1^2, 1/n_2^2, 1/n_3^2, 1/n_4^2) \times \Gamma, \quad (6.1.80a)$$

¹⁶It is known since the original proposal of 1978 [14] that the isotopies restrict the topological character of the isounit but otherwise leave its functional dependence completely unrestricted. This feature is at the foundation of the representation by hadronic mechanics of features such as density, extended shape, their deformation in time, etc., that are unthinkable with quantum mechanics.

¹⁷As we shall see in the next section, the value of the density of the Bose-Einstein fireball allows a numerically exact representation of all characteristics of the neutron as a hadronic bound state of an (iso)proton and an (iso)electron, including the numerical value of the anomalous magnetic moment, size, meanlife and other features that cannot even be treated with quantum mechanics.

$$\Gamma = \begin{pmatrix} A & B \times |1 - \exp(\int dx^4 \times \psi_{b2}^\dagger \times \psi_{a1})| \\ C \times |1 - \exp(\int dx^4 \times \psi_{a2}^\dagger \times \psi_{b1})| & D \end{pmatrix} \tag{6.1.80b}$$

and the quantities A, B, C, D , are restricted by the condition¹⁸

$$Det \Gamma = 1. \tag{6.1.81}$$

As one can see, when used in the isoexpectation value (6.1.79), isotopic element (6.1.80):

- (a) Allows indeed off-diagonal terms in the isoexpectation values;
- (b) Represents the overlapping of the wavepackets of particles via the integrals in the exponents of Γ ;
- (c) Eliminates all correlations when said overlapping is null, i.e., for the limit under condition (6.1.81)

$$Lim_{\int dx^4 \times \psi_{ij}^\dagger \times \psi_{jk} = 0} \Gamma = \begin{pmatrix} 1 & 0 \\ 0 & 1 \end{pmatrix}. \tag{6.1.82}$$

Next, the isorepresentation is given by a trivial isotopy of the conventional treatment [59], with the use now of the nontrivial isoexpectation values (6.1.78). We then have the *two-points isocorrelation function*

$$\hat{C}_2 = \frac{\hat{P}(p_1, p_2)}{\hat{P}(p_1) \times \hat{P}(p_2)} \tag{6.1.83}$$

where: $\hat{P}(p_1, p_2)$ is the *two-particle isoprobability density* subjected to proper symmetrization; $\hat{P}(p_k)$, $k = 1, 2$, is the corresponding quantity for the k particle with 4-momentum p_k ; and we ignore hereon the "hat" on variables for simplicity of notation.¹⁹

The two-particles isoprobability density is now given by the isoeigenvalue expression

$$\hat{P}(p_1, p_2) = \int \hat{\psi}_{12}^\dagger(x_1, x_2; r_1, r_2) \times \hat{T} \times \hat{\psi}_{12}(x_1, x_2; r_1, r_2) \times \hat{F}(r_1, r_2) \times d^4r_1 \times d^4r_2, \tag{6.1.84}$$

¹⁸Values of determinant (6.1.81) different than 1 would merely imply a different renormalization of the characteristic quantities.

¹⁹On rigorous grounds, it should be noted that isocorrelation function (6.1.83) is an isoscalar as it is the case for the isoline element (6.1.79a). This property is automatically guaranteed by the issue of an isoquotient. For these mathematical aspects, we recommend the noninitiated reader to study Chapter I.2.

where: $\hat{\psi}_{12}$ is the *isoamplitude* for the production, as in the conventional treatment, two bosons at r_1 and r_2 that are detected at x_1 and x_2 ; and the *isowavefunction* $\hat{\psi}_{ij}$ is given by a trivial isotopy of the conventional expression.

Note the crucial difference between Eq. (6.1.84) and (6.1.72) given by the isotopic lifting of all quantities and their operations and the appearance in the former of the isotopic element allowing the mixing of nondiagonal terms.

Another major difference between conventional and isotopic treatments is that *the probability densities for particles 1 and 2 are factorized in the conventional treatment (6.1.72), while they cannot be factorized in the isotopic treatment.* This is due to the fact that protons, antiprotons, and all produced mesons are point-like for relativistic quantum mechanics (as a necessary condition for a credible use of the underlying mathematics), while they are extended for the covering treatment. Hence, the separation of the densities would be equivalent to annulling all correlations.

The isotopy of the conventional treatment referred to isoexpectation values (6.1.78), including the symmetrization of the isotopic element and isowavefunctions for all possible directions, plus the assumed normalizations then leads to isodensity (9.11) of Ref. [63], i.e.,

$$\hat{F}(r_1, r_2) = \Sigma_{\mu} \hat{\eta}_{\mu\mu} \times \frac{b_{\mu} u^2}{4 \times \pi^2} \times e^{-\frac{1}{2} \times r^2 \times b_{\mu}^2} \quad (6.1.85)$$

where r can be interpreted as the radius of the sphere in which the correlated mesons are detected.

The continuation of calculations via a simple isotopy of the conventional treatment leads to the following expression of the two-points isocorrelation function derived for the first time in Eq. (9.12), p. 112, Ref. [63],

$$\begin{aligned} \hat{C}_2 &= 1 + \Sigma_{\mu} b_{\mu}^2 \times e^{-\frac{Q_{12}^2}{b_{\mu}^2}} = \\ &= 1 + b_1^2 \times e^{-\frac{Q_{12}^2}{b_1^2}} + b_2^2 \times e^{-\frac{Q_{12}^2}{b_2^2}} + b_3^2 \times e^{-\frac{Q_{12}^2}{b_3^2}} - b_4^2 \times e^{-\frac{Q_{12}^2}{b_4^2}}, \end{aligned} \quad (6.1.86)$$

where, again, $Q_{12} = p_1 - p_2$.

The case of the three-points and higher isocorrelation functions is treated in Ref. [63], and it is here ignored for simplicity.

The attentive reader will have noted that, to prevent a catastrophic mixing of conventional and isotopic treatments, the *isosquare* of Eq. (6.1.86) is explicitly given by

$$\hat{Q}_{12}^2 = \hat{Q}_{12}^{\mu} \hat{\times} \hat{\eta}_{\mu\mu} \hat{\times} \hat{Q}_{12}^{\mu} = Q_{12}^{\mu} \times \hat{\eta}_{\mu\mu} \times Q_{12}^{\mu}, \quad (6.1.87)$$

multiplied by the isounit that is hereon ignored for simplicity.

At this point, the exponent of expression (6.1.86), must be reduced to quantities actually measured in the tests, the momentum transfer q_t and the characteristics values of the fireball. This reduction was also done in Ref. [63] and resulted in the following expression

$$\frac{Q_{12}^2}{b_\mu^2} = \frac{q_t^2}{b'^2_\mu} \quad (6.1.88)$$

where b'^2_μ represents renormalized expressions of the characteristic quantities. However, their numerical value is unknown prior to fits of the experimental data. Hence, we assume $b'^2_\mu \equiv b_\mu^2$.

The final expression of the two-points isocorrelation function, derived for the first time in Eq. (9.25), page 119, Ref. [63] is given by one of the following equivalent expressions first achieved in Ref. [63], Eqs. (10.7), (10.8), (10.9), pages 121,122

$$\begin{aligned} \hat{C}_2 &= 1 + \frac{1}{3} \times \Sigma_\mu b_\mu^2 \times e^{-\frac{q_t^2 \times K^2}{b_\mu^2}} = \\ &= 1 + \frac{1}{3} \times b_1^2 \times e^{-\frac{q_t^2 \times K^2}{b_1^2}} + \frac{1}{3} \times b_2^2 \times e^{-\frac{q_t^2 \times K^2}{b_2^2}} + \frac{1}{3} \times b_3^2 \times e^{-\frac{q_t^2 \times K^2}{b_3^2}} - \frac{1}{3} \times b_4^2 \times e^{-\frac{q_t^2 \times K^2}{b_4^2}}, \end{aligned} \quad (6.1.89a)$$

$$K^2 = b_1^2 + b_2^2 + b_3^2. \quad (6.1.89b)$$

By absorbing the k^2 term into the characteristic quantities, we have the equivalent form

$$\hat{C}_2 = 1 + \frac{K^2}{3} \times \Sigma_\mu b_\mu^2 \times e^{-\frac{q_t^2}{b'^2_\mu}}, \quad (6.1.90a)$$

$$b'_\mu = b_\mu / K^2. \quad (6.1.90b)$$

Another isorepresentation is given by (page 129, ref. [63])

$$\hat{C}_2 = 1 + \times \Sigma_\mu b_\mu^2 \times e^{-\frac{q_t^2 \times K^2}{b_\mu^2}}, \quad (6.1.91a)$$

$$K^2 = b_1^2 + b_2^2 + b_3^2 = 3. \quad (6.1.91b)$$

In the above isorepresentations, all operations are now conventional. Hence, the above expressions are the *projections* in our spacetime of the isocorrelation functions on isospace.

6.1.10.E Reconstruction of the Exact Poincaré Symmetry under Nonlocal and Non-Hamiltonian interactions of the Bose-Einstein Correlation

As indicated earlier, a crucial insufficiency of the conventional treatment of the Bose-Einstein correlation, is the inability to provide an invariant representation of

the fireball, due to its prolate character under which the conventional rotational symmetry no longer applies.

As studied in detail in Volume I, a central objective of hadronic mechanics is to restore the exact character of basic spacetime and other symmetries when popularly believed to be "broken" due to the use of excessively elementary or insufficient mathematics. It is important to show the reconstruction of the exact rotational and other spacetime symmetries for the isorelativistic treatment of the Bose-Einstein correlation as done in memoir [63]. In fact, the most important predictions of the isorepresentation characterize structural deviations from special relativity whose understanding, let alone rigorous derivation, can only be done at the level of isosymmetries.

With respect to Fig. 6.9, recall that the Bose-Einstein correlation creates a fireball characterized by a spheroid prolated in the direction of the proton-antiproton flight. Following its creation, the fireball expands rapidly, resulting in the correlated mesons. Consequently, the original characteristic quantities, here denoted $b_k^2 = 1/n_k^2$, have an explicit dependence on time.

By assuming that the prolateness is along the third axis, we have

$$K^2(t) = b_1^2(t) + b_2^2(t) + b_3^2(t) \neq \text{const}, \quad b_3^2(t) \gg b_1^2(t) = b_2^2(t), \quad (6.1.92)$$

However, the fireball must preserve its shape during its expansion when considered as isolated from the rest of the universe. This implies that all characteristic quantities have the same factorizable time dependence, and we shall write

$$K^2(t) = k^2 \times f(t), \quad b_k^2(t) = f(t) \times b_k^2, \quad k, b_k = \text{const}. \quad (6.1.93)$$

This implies the following important property

$$\frac{b_k^2(t)}{b_1^2(t) + b_2^2(t) + b_3^2(t)} = b_k^2 = \text{const}. \quad (6.1.94)$$

that has been used for isorepresentation (6.1.89).

In conclusion, the fireball can be studied at the time of its formation with constant characteristic quantities $b_k^2 = 1/n_k^2$ and the following isoinvariant formulated on the Euclide-Santilli isospace with isounit

$$\hat{R}^2 = (x_1^2 \times b_1^2 + x_2^2 \times b_2^2 + x_3^2 \times b_3^2) \times \hat{I} = \left(\frac{x_1^2}{n_1^2} + \frac{x_2^2}{n_2^2} + \frac{x_3^2}{n_3^2} \right) \times \hat{I}, \quad (6.1.95a)$$

$$\hat{I} = \text{Diag.}(1/b_1^2, 1/b_2^2, 1/b_3^2) = \text{Diag.}(n_1^2, n_2^2, n_3^2). \quad (6.1.95b)$$

As studied in Chapter 1.3, *isoinvariant (6.1.94) characterizes the perfect sphere on isospace over the isofield, caled the isosphere, and characterizes an ellipsoid only in its projection in our space.* This is due to the mechanism of the isotopies

that, in this case, must be applied to the conventional sphere in conventional space, assumed for simplicity to have radius $r = 1$. In this case the semiaxes $r_k^2 = 1$ are indeed lifted into those of the ellipsoid, $r_k^2 \rightarrow b_k^2$, but the corresponding units are lifted by the *inverse* amount, thus preserving the perfect sphericity on isospace over isofields,

$$r_k^2 \rightarrow b_k^2, \quad 1_k^2 \rightarrow 1/b_k^2, \quad (6.1.96)$$

Once the perfect spherical character of the fireball on isospace is understood, the reconstruction of the exact rotational symmetry for ellipsoids is trivial. In fact, we have the *Lie-Santilli isoalgebra* $\hat{O}(3)$ (Ref. [63], page 115)

$$J_k = \epsilon_{ijk} r_i \times p_j, \quad (6.1.97a)$$

$$[J_i, J_j] = J_i \times \hat{T} \times J_j - J_j \times \hat{T} \times J_i = b_k^2 \times J_k, \quad (6.1.97b)$$

$$J^{\hat{2}} = J \times \hat{T} \times J, \quad (6.1.97c)$$

where we have ignored for simplicity factorization of the isounit.

It is trivial to prove that the above isorotational algebra is isomorphic to the conventional algebra (due to the positive-definite character of the characteristic quantities b_k^2), $\hat{O}(3) \approx O(3)$, and this proves the reconstruction by hadronic mechanics of the exact rotational symmetry when popularly believed to be broken, a feature proved since the original proposal [14] of 1978.²⁰

The reconstruction of the *exact Lorentz symmetry* $\hat{O}(3.1)$ for the Bose-Einstein correlation follows the same lines. Since the speed of light is assumed to be locally varying, we have *mutated light cones* of the type, e.g., in the (3.4)-plae

$$n\hat{2} = (x_3^2 \times b_3^2 - x_4^2 \times b_4^2) \times \hat{I} = \frac{x_3^2}{n_3^2} - \frac{x_4^2}{n_4^2} \times \hat{I}, \quad (6.1.98a)$$

$$\hat{I} = \text{Diag.}(1/b_3^2, 1/b_4^2) = \text{Diag.}(n_3^2, n_4^2). \quad (6.1.98b)$$

It is again easy to see that *the mutated light cone in our spacetime is the perfect light cone in isospace, called light isocone*, because, again, the mutation of each axis is complemented by the inverse mutation of the corresponding unit. The preservation of the original numerical values is then assumed by the structure of the isoinvariant, Eq. (6.1.69).

Once the light cone is exactly reconstructed on isospace for locally variable speeds of light, the reconstruction of the exact Lorentz symmetry became a trivial calculations (see Vol. I for brevity) and it is here left as an important exercise for the interested reader.

²⁰See EHM Vol. II for realizations of the isorotational symmetry with conventional structure constants.

The same situation occurs for translations, resulting in the reconstruction of the exact Poincaré symmetry $\hat{P}(3.1)$ for all possible nonlocal and non-Hamiltonian realizations of the Bose-Einstein correlation, as first proved in Refs. [3.4].

Recall that isorelativity and special relativity coincide at the abstract, realization-free level, as confirmed by the speed of light *in vacuum* to be the constant maximal causal speed in *isospace*. Consequently, *the understanding of the isorepresentation of the Bose-Einstein correlation requires the knowledge that, rather than "violating" special relativity as at times perceived, in reality allows the maximal possible enlargement of the arena of applicability of Einsteinian axioms.*

6.1.10.F Theoretical Predictions

It is important now to identify the theoretical prediction of isorepresentation (6.1.89) so that we can compare them below with experimental data.

Prediction 1: The minimum value of the two-points isocorrelation function, first identified in Ref. [63],

$$\hat{C}_2^{Min} = 1, \quad (6.1.99)$$

evidently holding for infinite momentum transfer.

Prediction 2: The maximal value is predicted to be

$$\hat{C}_2^{Max} = 1 + \frac{1}{3} + \frac{1}{3} + \frac{1}{3} = 1.67. \quad (6.1.100)$$

evidently holding for null momentum transfer. Prior to any fit, we can say that, for the isorepresentation to be valid, all data must remain between the above minimum and maximum values.

Prediction 3: Isorepresentation (6.1.89) also predicts the *maximum value of the isodensity*, occurring for \hat{C}_2^{Max} (Eq. (10.27, page 127, Ref. [63]). In fact, for $q_t = 0$ we have no correlations, in which case we have

$$b_k^2 = 1, \quad k = 1, 2, 3, \quad K^2 = b_1^2 + b_2^2 + b_3^2 = 3, \quad (6.1.101a)$$

$$\hat{C}_2^{Max} = 1 + \frac{K^4}{3} - \frac{K^2 \times b_4^2}{3} = 1.67, \quad (6.1.101b)$$

$$b_4^2 = 2.33, \quad n_4^2 = 0.429, \quad b_4 = 1.526, \quad n_4 = 0.654. \quad (6.1.101c)$$

Prediction 4: By assuming that $K^2 = 3$ and that the fireball is very prolate, e.g., with $b_3^2 = 30 \times b_1^2 = 30 \times b_2^2$, we obtain the following prediction on the remaining characteristic quantities

$$\begin{aligned} b_1^2 = b_2^2 = 0.043, \quad b_3^2 = 2.816, \\ b_1^2 = n_1^2 = n_2^2 = 10.666, \quad n_3^2 = 0.355 \end{aligned} \quad (6.1.102)$$

Needless to say, the above prediction is mainly referred to the *type* of isospace-time inside the fireball, rather than the numerical values per se, due to the lack of knowledge at this point of the prolateness of the fireball.

From the above predictions we then derive the following expected values²¹

$$\hat{\beta}^2 = \frac{b_3^2}{b_4^2} \times \beta > \beta^2, \quad (6.1.103a)$$

$$\hat{\gamma} = \frac{1}{(1 - \hat{\beta}^2)^{1/2}} < \gamma. \quad (6.1.103b)$$

From the isoaxioms of Section 6.3, we then have the following additional predictions:

Prediction 5: The maximal causal speed within the fireball is *bigger* than that in vacuum,

$$V_{max} = c_o \times \frac{b_4}{b_3} > c_o; \quad (6.1.104)$$

Prediction 6: Time t within the fireball flows faster than time predicted by special relativity),

$$t = \hat{\gamma} \times t_o > \gamma \times t_o; \quad (6.1.105)$$

Prediction 7: Lengths ℓ inside the fireball are smaller than lengths predicted by special relativity,

$$\ell = \hat{\gamma}^{-1} \times \ell_o < \gamma \times \ell_o; \quad (6.1.106)$$

Prediction 8: Mass behavior with speed is bigger than that predicted by special relativity,

$$m = \hat{\gamma} \times m_o > \gamma \times m_o; \quad (6.1.107)$$

Prediction 9: The energy equivalence of the fireball is bigger than that predicted by special relativity or, equivalently, for a given energy, the mass is smaller),

$$E = m \times V_{max} > E_o = m \times c_o^2; \quad (6.1.108)$$

Prediction 10: Frequencies of light emitted inside the fireball, exist the same *isoblueshifted*, namely, with an increase of frequency as compared to the corresponding behavior p[redicted by special relativity

$$\omega = \hat{\gamma} \times \omega_o. \quad (6.1.109)$$

²¹The reader may note the use of the absolute value for the definition of the $\hat{\gamma}$ in footnote 42, page 123, Ref. [63]. This was due to the lack, at the time of that memoir (1992), of experimental data on the maximal causal speed within physical media, especially those opaque to light. This information was reached subsequently with the identification of Isoaxiom I. Eq. (6.1.11), with $V_{max} = c_o \times b_4/b_3$, in which case the speed v is always smaller than or equal to V_{max} , $\hat{\beta} \leq 1$, $\hat{\gamma}$ can only assume real values, and the absolute value is no longer necessary.

Prediction 11: The speed of light within the fireball is bigger than that in vacuum,

$$c = c_o > b_4 > c_4, \quad (6.1.110)$$

by smaller than the maximal causal speed

$$c = c_o \times b_4 < V_{max} = c_o \frac{b_4}{b_3}. \quad (6.1.111)$$

As one may recall from Volume I, the isoblueshift of light is nothing mysterious because it is a mere manifestation of the high energy density of the medium in which light propagates. Isoblueshift, as the increase of frequencies as predicted by special relativity in vacuum, is then a mere consequence of the medium transfer energy to light. A similar situation occurs for all other predictions.

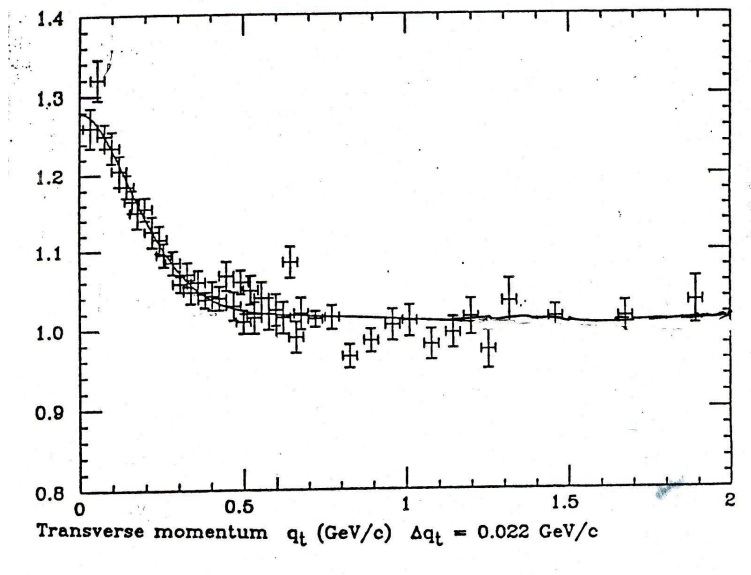

Figure 6.10. The exact fit of Santilli's two-point isocorrelation function (6.1.89) of the Bose-Einstein correlation at high energy made via the use of the experimental data from the UA1 tests at CERN [66]. The fit was done by F. Cardone and R. Mignani via a private communication to the author of 1992.

6.1.10.G Experimental verifications

It is rewarding for the author to report that *the fit of the experimental data on the Bose-Einstein correlation at high energy with the data of the UA1 experiments at CERN [66] have confirmed all the above predictions beyond the most optimistic expectations.*

The fit of Eq. (6.1.89) presented in Figure 5, page 129, Ref. [63] was conducted by F. Cardone and R. Mignani in 1992, initially reported to the author as a private communication, and then published in Ref. [64] of 1996, Table 1, page 441, resulting in the following numerical values of the characteristic functions for the fireball of the Bose-Einstein correlation

$$b_1 = 0.267 \pm 0.054, \quad b_2 = 0.437 \pm 0.035, \quad b_3 = 1.661 \pm 0.013, \quad b_4 = 1.653 \pm 0.015, \quad (6.1.112b)$$

A most important feature of the above data is that they *characterize the medium inside the fireball as being iso-Minkowskian of Group III, Type 9, thus confirming that all hadrons heavier than kaons have the same iso-Minkowskian features.* As we shall see, these geometric characterizations have primary relevance for further advances.

The fit of Figure 6.10 and the above values provide the following experimental verifications:

- (1) The experimental data do indeed lie between the theoretical minimum (6.1.99) and maximal value (6.1.100);
- (2) The experimental data confirm all eleven theoretical predictions (6.1.101) to (6.1.111);
- (3) The experimental confirm the reconstruction of the exact character of the Poincaré symmetry for the Bose-Einstein correlation.

77).

In summary, *the fit of Figure 6.10 provides the fourth direct experimental verification of Santilli isorelativity and relativistic hadronic mechanics, this time, in their most fundamental assumption, the historical legacy of the nonlocality of strong interactions. In particular, this additional experimental verification is fully compatible with all preceding ones.*²²

²²The reader should be aware of the following comments on the fit of the UAI data done in Ref. [64]:

1) Fit [64] is done for *eight* parameters, the b_μ , $\mu = 1, 2, 3, 4$ of the original derivation [63], plus four new parameters a_μ . This assumption turns the analysis equivalent to the conventional one, in the sense that four out of the eight parameters are equivalent to the chaoticity parameters of Eq. (6.1.77) because the Bose-Einstein correlation can only characterize *four* physical quantities, the three semiaxes of the fireball and its density. The reader should be aware that the additional four parameters a_μ are inessential for the fit. Hence, relativistic hadronic mechanics requires no free parameters for the fit.

2) The redundancy of four out of eight parameters of fit [64] is confirmed by the fact that the b_μ and a_μ parameters are proportional to each other, because

$$b_1 = 0.267, \quad b_2 = 0.0437, \quad b_3 = 1.661, \quad (a)$$

$$a_1 = 0.053 \times 10^{-13}, \quad a_2 = 0.086 \times 10^{-13}, \quad a_3 = 0.328 \times 10^{-13} \quad (b)$$

with ratios

$$\frac{b_1}{a_1} = 5.037 \times 10^{13}, \quad \frac{b_2}{a_2} = 5.081 \times 10^{13}, \quad \frac{b_3}{a_3} = 5.064 \times 10^{13}, \quad (c)$$

in which the very small differences of the above ratios being well within the error.

The above proportionality eliminates the need for one of the two sets of parameters because, as stressed in Ref. [63], *the characteristic quantities are always defined up to an arbitrary factor in view of the*

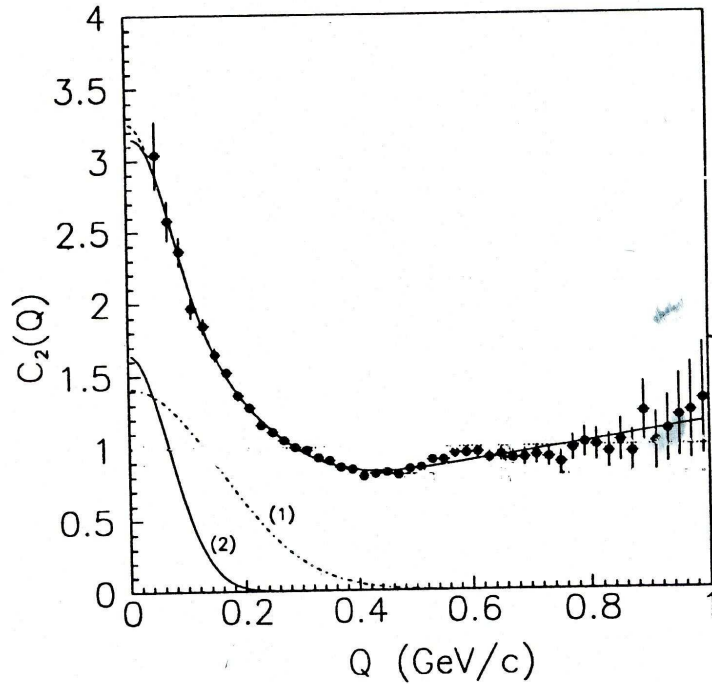

Figure 6.11. An illustration of another exact fit of the Bose-Einstein correlation from first axiomatic principles, this time of the proton-antiproton annihilation at very low energies, which can be obtained via the methods of this section. Its explicit study is left as an instructive exercise for the interested reader.

The repetition of the above analysis and related verification with the experimental data of the Bose-Einstein correlation at low energies (Figure 6.11) is left as an instructive exercise for the interested reader.

isotopic invariance (6.1.69), that can be explicitly written for an arbitrary (non-null) constant C (see also Eq. (6.1.79))

$$\hat{x}^2 = [x^\mu \times (\hat{T}_\mu^\nu \times \eta_{\nu\rho}) \times x^\rho] \times \hat{I} = [x^\mu \times (C \times \hat{T}_\mu^\nu \times \eta_{\nu\rho}) \times x^\rho] \times (C^{-1} \times \hat{I} = \hat{x}^2. \tag{d}$$

This is the reason that the characteristic quantities are normalized to the value of the vacuum, $b_\mu = 1$.
 3) All formulations of Ref. [64] are based on spaces defined over conventional fields, i.e., they deal with conventional "deformations," thus dealing with conventionally nonunitary time evolutions. As a result, Ref. [64] activates the *Theorems of catastrophic Mathematical and Physical Inconsistencies* studied in detail in Section 1.5, and briefly outlined in Section 6.6.. Nevertheless these inconsistencies do not apply to values (6.1.112) since the latter are obtained by fitting expression (6.1.89) already reduced to formulations on conventional spaces over conventional fields.

Another instructive exercise for readers interested in learning hadronic mechanics is to re-derive the entire results of this section via the simple method of a nonunitary transform of the conventional treatment according to Eqs. (6.1.22) (see Section 1.3.5 for more details).

In closing, the author would like to express his sadness for the excessive abuses of the name "Einstein" through the 20-th century and continuing to this day. There is no doubt that Albert Einstein is the biggest scientist of the 20-th century, with historical contributions to mankind deserving the highest respect by all.

However, it is equally true that Albert Einstein is the scientist most abused in the history of science because mediocre academicians improperly used and abused his name for personal gains in money, prestige and power.

The use of the name "Einstein" in the "Bose-Einstein correlation" has been one of several cases of abuses of Einstein's memory because Einsteinian theories are *inapplicable* (rather than "violated") in the field, since Einstein never studied dynamical problems in the interior of hyperdense media, such as the fireball, that were inconceivable at his time.

The difference in stature between Einstein and his followers is established by the writings. Einstein has a justly deserved, towering place in the history of science because he clearly identified in his limpid writings the arena of applicability of his theories, point particles and electromagnetic waves propagating in vacuum. The comparatively lilliputian dimension of physicists abusing his name is set in history by the absence, for evident political reasons, of identification of limitations that are inherent in any physical theory.

6.1.11 Experimental Verifications in Astrophysics

One of the unsolved mysteries of contemporary astrophysics is the experimental confirmation (see Ref. [67]) of the hypothesis (see Refs. [68,69]) that certain *quasars* are physically connected to associated *galaxies*, even though they have dramatic differences in their *cosmological redshifts* (see Figure 6.12).

The Einsteinian treatment of cosmological redshift requires its interpretation via *motion in vacuum away from us*, resulting in the well known *expansion of the universe*. However, the evidence that quasars and galaxies with dramatically different redshifts are physically connected, thus move with the same speed, prevents any serious or otherwise scientific representation via Einsteinian theories, whether in Minkowski or Riemannian spaces.

Numerous interpretations of the above anomalous occurrence have been attempted, such as the hypothesis that the difference in cosmological redshift is due to *creation of matter* within the quasars [69]. However, none of these interpretations have acquired the necessary numerical representation for scientific credibility.

In 1991, Santilli [6] proposed the simplest possible explanation according to which the indicated difference in cosmological redshifts is merely due to *the slow-down of the speed of light in the huge quasar chromospheres* (that can be as large as entire galaxies), similar to the slow-down of the speed of light in our atmosphere (Section 6.1.7). As a result, light exits the quasar chromospheres already redshifted. A similar phenomena does not exist in the same magnitudes for a galaxy because their stars are isolated in space, and have dramatically smaller chromospheres. In this way, light from physically connected quasars and galaxies having the same expansion speed, can reach us with dramatically different redshifts.

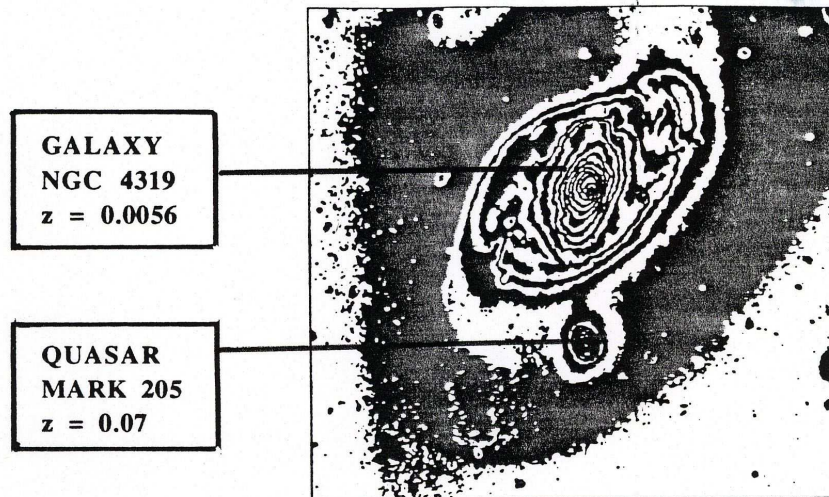

Figure 6.12. An example of clear evidence of astrophysical conditions beyond the capabilities of Einstein's special and general relativity or, equivalently, beyond the Minkowskian and Riemannian geometries: the experimentally verified (Ref. [67]) physical connection between the galaxy NGC 4319 and the quasar Mark 205, via the superposition of several gamma spectroscopic plates. By contrast, the quasar Mark 205 has a redshift with $z = 0.07$, while the associated galaxy NCG 4316 has a redshift of only $z = 0.0056$. The interpretation of this difference requires necessary departures from the Minkowskian and Riemannian geometries, because such a large difference would require that the quasar has at least 104 times the speed of the galaxy, under which conditions the quasar and its associated galaxy would have separated completely billions of years ago. Santilli's iso-Minkowskian geometry permits an exact, numerical, and invariant representation of the indicated large difference in cosmological redshifts, while restoring the abstract Minkowski and Poincaré axioms on isospaces over isofields.

The effect can first be read off in the expansion of the Minkowskian redshift (here presented for simplicity for the case of null aberration)

$$\omega = \omega_o \times (1 - v/c_o) \times \gamma \approx \omega_o \times [1 - v/c_o + \frac{1}{2} \times (v/c_o)^2 + \dots] \quad (6.1.113)$$

Since $v \ll c_o$, it is evident that a decrease of c_o will imply an increase of the redshift.

It was shown in Ref. [6], Vol. II, that the above equation is insufficient to represent astrophysical evidence, e.g., because chromospheres are anisotropic (due to their rotation) and inhomogeneous (due to the decrease of the density with the increase of the radial distance from the center), while the geometry underlying law (6.1.113) is purely isotropic and homogeneous.

By using Isopostulate IV, Eq. (6.1.14), Santilli [*loc. cit.*] suggested the following *isodoppler law* for the cosmological redshift

$$\begin{aligned} \omega &= \omega_o \times [1 - (v \times b_3/c_o \times b_4) \times \hat{\gamma} \approx \\ &\approx \omega_o \times [1 - \beta \times (b_s/b_4) + \frac{1}{2} \times \beta^2 \times (b_s/b_4)^2 + \dots] \end{aligned} \quad (6.1.114)$$

where n_s is the space characteristic quantity in the direction of emission of light, assuming the source to be spherical for simplicity. As one can see, the above isolaw predicts an additional contribution in the redshift due to the anisotropy and inhomogeneity of quasar chromospheres.

In 1992, R. Mignani [70] provided a direct experimental verification of Santilli's Isopostulate IV and related isodoppler law for all the most important pairs of quasars and associated galaxies. The verification was done via the parameter

$$B = \frac{b_s}{b_4} = \frac{(\delta\omega + 1)^2}{(\delta\omega + 1)^2 + 1} \times \frac{\delta\hat{\omega} + 1)^2 - 1}{\delta\hat{\omega} + 1)^2 + 1}, \quad (6.1.115)$$

where $\delta\omega$ represents the measured Einsteinian redshift for galaxies, and $\delta\hat{\omega}$ represents the isotopic redshift for quasars according to Santilli's law (6.1.114).

A most important consequence of the data of Figure 6.14 is that *quasars chromospheres are iso-Minkowskian media of Group II, Type 5* (Figure 6.3). In this way, the anomalous redshift behavior here considered is reduced to the axiomatic geometric characterization of the inhomogeneity and anisotropy of astrophysical chromospheres. As we shall see, this geometric characterization will allow numerical predictions for the isoredshift expected by Sun light at sunset.

It is evident that the data of Figure 6.13 provide another experimental verification of the the very central assumption of Santilli isorelativity, the *novel modification (called mutation) of spacetime caused by physics media*, where "novelty" is intended to clarify that said modification *is not* of gravitational or any

GAL.	ω'_1	QUASAR	B	$\hat{\omega}_2$
NGC	0.018	UB1	31.91	0.91
		BSOI	20.25	1.46
NGC 470	0.009	68	87.98	1.88
		68D	67.21	1.53
NGC 1073	0.004	BSO1	198.94	1.94
		BSO2	109.98	0.60
		RSO	176.73	1.40
NGC 3842	0.020	QSO1	14.51	0.34
		QSO2	29.75	0.95
		QSO3	41.85	2.20
NGC 4319	0.0056	MARK205	12.14	0.07
NGC 3067	0.0049	3C232	82.17	0.53

Figure 6.13. A summary of Mignani's data [70] verifying Santilli's isorelativity for all major quasars that are physically associates to galaxies according to clear spectroscopic or other evidence, while having dramatically different cosmological redshifts.

previously known nature, but intrinsic in the anisotropy and/or inhomogeneity of the media.²³

Yet another experimental verification of Santilli isorelativity is given by the exact, numerical, and invariant representation [71] of the *internal red-, and blue-shift of quasars*. We are here referring to the unexpected behavior whereby, for a given cosmological redshift, there can be relatively smaller shifts toward the red or toward the blue. This is a phenomenon that clearly confirmed Santilli's isorelativity because it is known since Newton times, although not admitted for personal gains, that the index of refraction of light has an explicit dependence on the frequency, resulting in the beautiful separation of light into its various colors via a crystal. But the index of refraction is the characteristic quantity $1/b_4 = n_4$. Hence, the quasars blueshifts and redshifts can be explained in a trivial way via Santilli's isorelativity, via a simple functional dependence of the

²³Again, we use the word "mutation" suggested since the original proposal of hadronic mechanics, Re. [14], referring to formulation defined on isospaces over isofield, so as to distinguish them from "deformations," namely, formulations defined on conventional spaces over conventional fields, because the catastrophic inconsistencies of the latter (Sections 1.3.5 and 6.1.6) were already known in 1978.

characteristic quantities on the frequency, $b_\mu = b_\mu(\omega, \dots)$ (Figure 6.14). See Ref. [71] for details and fits due to their simplicity.

Note the absolute impossibility for special and general relativities to represent the astrophysical data of this subsection. Hence, the covering relativity that is applicable for interior astrophysical problems is open to scientific debates, but the denial of its need is outside scientific or credible doubt

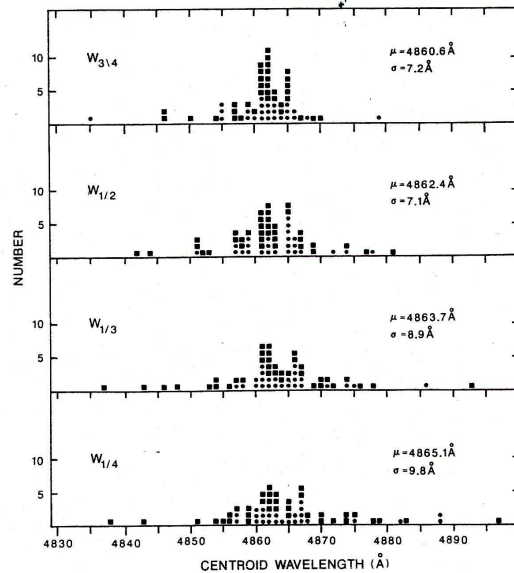

Figure 6.14. A schematic view of Sulentic's [67] discovery of the internal red- and blue-shift of quasars, that is, the decrease or increase of the cosmological redshift of quasars with corresponding variations of the light frequency. The latter occurrence is a further experimental confirmation of the validity of Santilli's iso-Minkowskian geometry for quantitative representations of cosmological redshifts. In fact, the evidence establishes a dependence of the redshift with the frequency, which is evidence of propagation of light within physical media fully known, although not admitted as of lately, since Newton's times. The iso-Minkowskian geometry then applies, e.g. because of its direct universality for interior conditions.

6.1.12 Verification via the Absence of Dark Matter and Energy

Recent astrophysical observations have established that matter in the visible universe, when computed with conventional theories, is substantially insufficient for a quantitative explanation of numerous astrophysical events, including galaxy evolutions, lensing effects, temperature distribution of hot gases, cosmic

microwave background, and other events. Specific calculations indicate that, at this writing (October, 2007) matter (or energy) in the universe as above defined can only account for 3 % of the needed mass (or energy). Consequently, 93 % of the needed mass (or energy) is missing.

The above data lead to the proposal and widespread propagation of the conjecture of *dark matter (or energy)*, (see Ref. [72] for a readable account and main references) according to which the missing 93 % is carried by an unknown state of matter capable of experiencing and causing gravitation (as an evident necessary condition for a credible explanation of gravitational anomalies), yet it is "dark" in the sense of not being visible, thus not emitting or absorbing radiations, and having additional quite implausible peculiarities identified below.

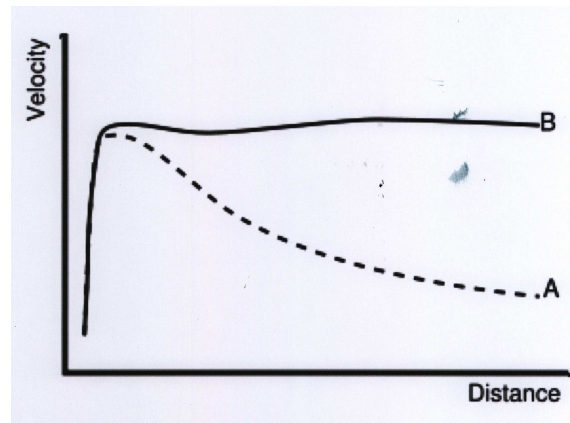

Figure 6.15. A typical illustration of the claimed need for "dark matter" [72] in a very large amount: the predicted rotation of stars in a spiral galaxy (A) and the observed behavior (B). As one can see, the observed rotation behavior is *bigger* than that predicted by orthodox calculations. The aspect that turns the conjecture of "dark matter" into a theology is that "dark matter" should it decrease, rather than increase, the rotational motion of stars, evidently because, when assumed to constitute 93 % of the mass in the universe, "dark matter" becomes a physical medium with consequential "dark matter wind," namely, the necessary creation of a *resistance* that stars should experience while moving in the "dark matter sea." In reality, it is known by experts in the field that the conjecture of "dark matter" was submitted for the pre-meditated scope of maintaining the dominance of Einsteinian theories in conditions for which they are inapplicable. In fact, as soon as necessary deviations from Einsteinian theories are admitted in the interior of stars, quasars and black holes, there is no need at all for theological conjectures to explain the dynamics of the universe.

It is known by well informed scientist that *the conjecture of dark matter was suggested for the specific intent of salvaging the validity of Einstein special relativity in the interior of stars, quasars and black holes.* In particular, the conjecture was voiced at the time of mounting theoretical and experimental evidence of the *inapplicability* (rather than "violation") of Einsteinian doctrines in the indicated

conditions for numerous reasons, such as the emerging locally varying character of the speed of light within physical media (see Section 6.1.8 and review paper [40]).²⁴

In fact, the conjecture of "dark matter" is a direct consequence of the use in astrophysical calculations of the Einsteinian energy equivalence

$$E = m \times c_o^2, \quad (6.1.116)$$

where c_o is the speed of light *in vacuum*.

Said conjecture remains implausible for several reasons indicated below, the most damaging one being the lack of a "dark matter wind" during the motion of stars. In fact, the assumption that the visible mass is only 3 % of that existing in the universe, implies that stars must move within a "dark matter sea." Under such a condition, the dynamics of stars is expected to be the *opposite* of what ventured, namely, "dark matter" should *decrease* the rotation of stars in galaxies, rather than increase them as, per primary scope of the conjecture.

The alternative is to assume that 93 % of the mass in the universe is in a state of "evanescence" so as not to cause the "dark matter wind" during the motion of stars, yet it causes gravitational effects. Such an unverifiable conjecture to support an unverifiable conjecture would cause exiting the boundaries of serious science.

As typical for all directly unverifiable conjectures ventured for the intent of salvaging Einsteinian theories, the conjecture of "dark matter" is now being complemented by additional unverifiable conjectures, such as that "*dark matter*" is composed by the hypothetical neutrinos (see next section for the basically unsettled character of the neutrino conjecture). The clear (but unspoken) intent here is to abuse academic credibility on the "evidence" for the existence of the hypothetical neutrinos as "evidence" in support of the conjecture of "dark matter," all for the pre-meditated intent of preserving Einsteinian doctrines, while studiously avoiding a mention of their possible inapplicability under extreme conditions simply unthinkable during Einstein's times.

Needless to say, studies along the above theological lines should certainly be allowed to continue.²⁵ However, the field would be turned into an illusory science

²⁴Rather unreassuringly, the U. S. Department of Energy has recently advertised, rather widely, the availability of public funds specifically earmarked for the study of "dark energy," thus with a mirror condition existing at the U. S. national Science Foundation, thus fueling rumors that U. S. Federal Agencies are controlled by organized interests on Einsteinian doctrines without a serious commitment to much needed basic advances. It is assumed that even the most unscrupulous reader will not dare to deny that strict verification of Einsteinian doctrines is a mandatory condition for securing *contemporary* federal research contracts. Documentation to the contrary would be gratefully appreciated by the author.

²⁵Provided that papers written and published under public U. S. financial support explicitly quote the tentative nature of the research and the expected inapplicability of Einsteinian doctrines in the field, so as to avoid violations of U. S. Laws suitable for legal prosecution.

in the event said theological studies are not complemented with research based on *deviations* from Einsteinian doctrines within the hyperdense media inside stars, quasars and black holes.

It is hereon assumed the reader is aware of the fact that *gravitation originates from the energy of given bodies and not from their mass, the latter merely representing their inertia*. The popular misconception of assuming mass as the source of gravitation originates from Newton's equation

$$m \times \frac{dv}{dt} = F, \quad (6.1.117)$$

that was automatically extended for centuries to Newtonian gravitational attraction

$$F = G \times \frac{m_1 \times m_2}{r^2} \quad (6.1.118)$$

However, the force F in Newton's equation (6.1.117) is identically null for bodies at a constant mutual distance for which $dv/dt = 0$, while the force F in Eq. (6.1.18) is not null for the same conditions. Hence, recent studies (see EHM II and references quoted therein) have indicated that the more appropriate version of the gravitational attraction is that in terms of the energy content of the bodies,

$$F = S \times \frac{E_1 \times E_2}{r^2}, \quad (6.1.119a)$$

$$S = \frac{g}{c_o^4}. \quad (6.1.119b)$$

Needless to say, it is popularly known that formulations (6.1.18) and (6.1.19) are equivalent, since the passage from one to the other is given by a mere numerical proportionality. Such an equivalence is unquestionable for the conditions of exact applicability of Einstein's energy equivalence, namely, for *point particles moving in vacuum*.

What does not appear to be popularly known is that the equivalence between Eqs. (6.1.18) and (6.1.19) is lost when referred to *extended bodies with hyperdense interior media*, because the speed of light is no longer the maximal causal speed, assuming that light can propagate in the medium considered.

Hence, from now on, the physically important issue is the *missing energy*, in the universe, and not the missing mass.. Again, the latter merely represents the inertia as traditionally conceived through centuries, namely, as the matter tendency to oppose changes of speed. As such, inertia cannot possibly be the source of gravitation, thus leaving the energy as the only source available at this writing.

The reader accustomed to throw judgment via a quick glancing at topics in which he/she has no technical knowledge,²⁶ should be warned that the need to use

²⁶The author remembers "distinguished" colleagues, including a Nobel Laureate in Physics, refereeing papers during the duration of time for the elevator to reach the physics department second floor. For

energy as the true gravitational source requires a serious technical knowledge of isomathematics (EHM Vol. I and Section 3.2) including the geometric unification of the Minkowskian and Riemannian geometries and a serious resolution of the *Nine Theorems of Catastrophic Inconsistency of Einstein's Gravitation* studied in Section 1.4 [73].

At any rate, *the use of energy as the source of gravitation, rather than mass, is mandated by experimental evidence that light has no mass, yet it experiences gravitation, such as in the case of the bending of light when passing near astrophysical bodies.* In this case we evidently have the gravitational attraction

$$F = S \times \frac{E_{mass} \times E_{light}}{r^2}. \quad (6.1.120)$$

Hence, the restriction of gravitational sources to mass would solely admit *some* gravitational events in the universe, while the use of energy would admit them *all*.

As an obvious comment, the above reformulation of gravity fully represents the data of our Solar system, because the currently assumed gravitational fields of the Sun and planets are identically reformulated from mass to their isoequivalent energies. However, the reformulation is, by far, non trivial, e.g., because it may provide new insights in interior gravitational problems, such as the speed of light and maximal causal speed inside the Sun.

Under the above clarifications, we can quote Santilli's view [74] according to which *isorelativity eliminates the need for dark matter and energy either in full or in part.* In fact, Isoaxiom V, Eq. (6.1.15), predicts that the energy equivalence of a given mass is given by

$$\hat{E} = m \times c_o^2 \times \frac{b_4^2}{b_s^2} = m \times c_o^2 \times \frac{n_s^2}{n_4^2}, \quad (6.1.121)$$

where we have assumed for simplicity a perfect sphericity of astrophysical bodies resulting in the single value $b_s = 1/n_s$.

Santilli then pointed out that the "missing energy" ΔE can be accounted for via the value [*loc. cit.*]

$$\Delta E = m \times c_o^2 \times \left(\frac{b_4^2}{b_s^2} - 1 \right) = m \times c_o^2 \times \left(\frac{n_s^2}{n_4^2} - 1 \right). \quad (6.1.122)$$

Under the assumption that the mass of the universe, when computed via Einsteinian theories, is only 3 % of the needed mass, the behavior of stars and other

the intended "review," this time is amply sufficient to identify the affiliation of the author and the compatibility of the content with Einsteinian theories.

objects in the universe can be explained via the following *average isotopic characteristics of the universe* applicable for the hyperdense medium inside stars, quasars and black holes

$$\frac{b_4^2}{b_s^2} = \frac{n_s^2}{n_4^2} = 94, \quad (6.1.123)$$

As an example, by using ordinary gauge theories, Ref. [42] computed the average value of the speed of light within hyperdense hadronic media to be 75-times that in vacuum, in which case we have

$$c = 75 \times c_o, \quad b_4^2 = 75, \quad b_s^2 = 0.079 \quad (6.1.124)$$

Needless to say, calculations [42] are merely approximate. Yet, the view that the conventional mass equivalent necessarily holds in the interior of black holes, has no scientific credibility.

Needless to say, value (6.122) and (6.1.123) are an *average* for the entire universe, under the understanding that they are based on current estimate of 93 % missing energy. Also, the values are expected to vary dramatically from stars to black holes, the latter being arguably the origin of the biggest contributions.

It should also be noted that isorelativity provides a *partial* elimination of the missing energy, because every point in space is traversed by light coming from the entire universe, thus characterizing a clear energy. Additional energy everywhere in space is provided by ordinary massive particles, such as cosmic rays, hydrogen, etc. Clearly, the latter component characterized by ordinary electromagnetic waves, particles and hydrogen has to be computed before finalizing the value of the average isotopic characteristic of the universe. Note that the latter conventional component is dramatically insufficient to account for all missing energy.

In summary, recent theological trends in astrophysics, for the pre-meditated scope of adapting nature to Einsteinian theories, have conjectured the existence of a mysterious substance existing in our spacetime, capable of experiencing and causing gravity, but unable to absorb or emit electromagnetic waves, not causing a "dark matter wind" in the motion of stars, being uniformly distributed at times to explain star rotations in Galaxies (Figure 6.15) while being entirely concentrated in a point to explain lensing effects Figure 6.16) and having other manifest basic flaws.

In this section, we have shown that the dynamics of the universe can be interpreted quantitatively by adapting the theories to the evidence, in this case, by honoring the *exact* validity of Einsteinian theories for the physical conditions limpidly expressed by Einstein ("point-particles and electromagnetic waves propagating in vacuum"), and by halting the abuse of Einstein's name and memory in pushing said validity beyond the arena of their original conception and exper-

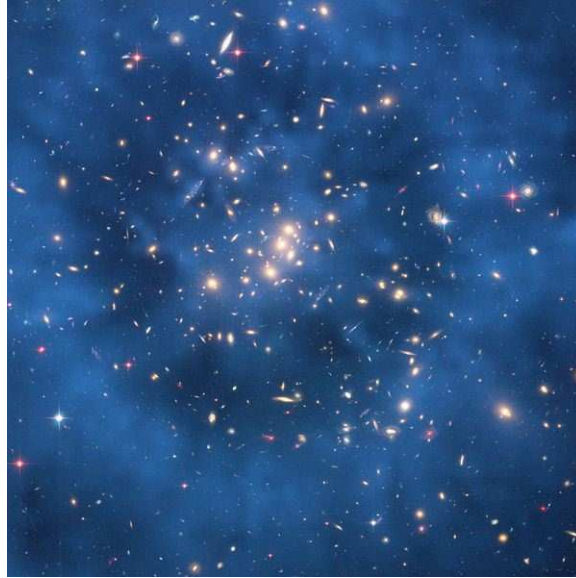

Figure 6.16. Another illustration of the widespread political preservation of Einsteinian theories under conditions for which they are inapplicable: the use of lensing effects in the universe as "evidence" in support of the conjectural "dark matter." The posturing is political because the indicated lensing effect is well known to be solely due to a highly concentrated mass in one of the foci, while the conjectural "dark matter" must be uniformly distributed in space to "interpret" the behavior of Figure 6.15. This is reminiscent of the case about one century ago of using the bending of light near an astrophysical body as "evidence" of the curvature of space, while in reality that bending is entirely due to Newtonian attraction, and, in the event curvature does indeed cause the bending of light, the prediction of Einstein's gravitation is double that measures [73]. The fact that curvature cannot possibly explain the free fall of bodies along a straight radial line, even though known to high school students, was suppressed, at times studiously, to serve a political purpose in science.

imental verifications, to the contemporary extremes of manipulation of scientific evidence that can only be euphemistically qualified as theological at best.²⁷

²⁷The author would like to:

- 1) Set a record for having received today, October 11, 2007, a visit from the Italian-British scientist, industrialist and philanthropist from London, **Dr. Francesco Fucilla**;
- 2) Indicate that, if properly supported by scientists, educators, politicians, economists, industrialists and historians who care about human knowledge, Dr. Fucilla can be the coordinator of a much needed *new scientific renaissance* comparable to that originated by Lorenzo de' Medici (called "Il Magnifico") in the the 1500's, not only because of Lorenzo's superior vision, but also because of the support he received by luminaries such as Andrea del Verrocchio, Leonardo da Vinci, Sandro Botticelli, Domenico Ghirlandaio, Filippino Lippi, Michelangelo Buonarroti and so many others.
- 3) Note with pride that Dr. Fucilla is Italian.

6.1.13 Experimental Verifications via Supernova Explosions

There is little doubt that contemporary astrophysics is one of the most theological fields of contemporary science due to the assumption of numerous fundamental aspects without serious theoretical and/or experimental evidence, and/or serious scrutiny, such as:

1) The most fundamental event in astrophysics, the *synthesis of the neutron from protons and electrons*,



is basically unknown at this writing on both theoretical and experimental grounds. On theoretical grounds the synthesis is basically unsettled because the rest energy of the neutron is 0.78 MeV *bigger* than the sum of the rest energies of the proton and the electron. Under these conditions quantum mechanics is fundamentally inapplicable due to the lack of physical meaning of Schrödinger's equations under the necessary *positive* binding energy of 0.78 MeV (in which case there is no energy available for the hypothetical neutrino). Yet, quantum mechanics is routinely applied for all calculations known to the author. On experimental grounds, the insufficiency is even greater due to the rejection by laboratories around the world of the author proposal over decades of testing synthesis (6.1.125), evidently due to its incompatibility with established doctrines (see next chapter for details). lacking fully established theoretical and experimental knowledge on the first and most fundamental synthesis (6.1.125) in a star, the rest of "astrophysics" (that is, the physics of stars") is evidently unsettle on serious scientific grounds.

2) Contemporary astrophysics is additionally based on the belief that neutrinos are physical particles in our spacetime. However, the only available quantitative representation of synthesis (6.1.125), that provided by hadronic mechanics, does not need the neutrino at all, as shown in the next section; as limpidly stated by Enrico Fermi, neutrinos cannot be experimentally detected; the indirect detections believed to be caused by neutrinos have alternative interpretations; and the neutrino conjecture remains afflicted by a number of unsettled aspects that multiply in time, rather than decrease, because unspoken. Under these conditions, any astrophysical model depending on neutrino conjectures is evidently unsettled on serious scientific grounds.

3) Astrophysical observations are interpreted via spectral analysis established on earthly experiments, namely, on the spectral emissions of essentially unperturbed atoms, while it is known that atoms subjected to extreme conditions have spectral emissions *different* than those from ideal conditions. In more explicit terms, the spectral emission, for instance, iron under the extreme densities and pressures in the core of a star is expected to be dramatically different than the spectral emission of iron as measured on in our laboratories.

28

At any rate, after one century of studies, the spectral emission of our Sun is still basically unknown to the authors best knowledge, e.g., because of spectral lines that should originate from orbits *smaller* than the ground state of the hydrogen, and similar unresolved anomalies. Under these conditions, the theoretical interpretation of spectral lines from a far away star, quasar or supernova via quantum mechanics can only be qualified as being unsettled at best.

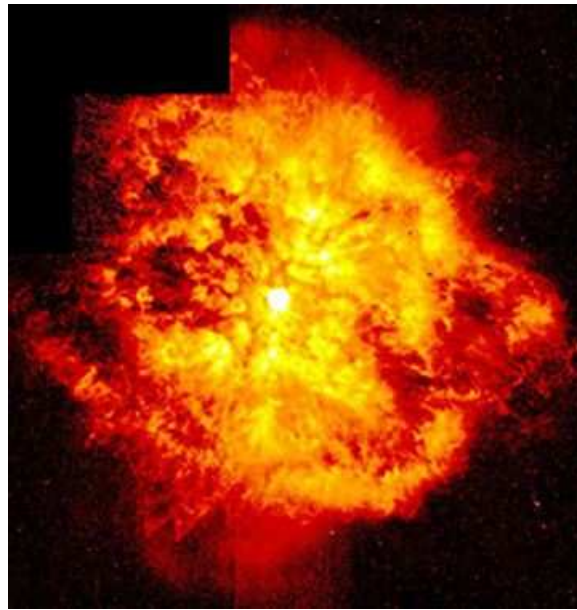

Figure 6.17. A NASA image of the nebula WR124 located 21,000 light years away showing the remnants of a supernova.

For the receptive young mind of any age interested in knowledge (rather than an academic career), the author suggest, as a pre-requisite for endless, fundamental new discoveries, to keep an open mind and study as a matter of principle *all* possibilities permitting quantitative interpretations, irrespective of wether via the use of quantum or hadronic mechanics.

²⁸It is appropriate to recall here that quantum mechanics has achieved an exact representation of the spectral emission solely of the hydrogen atom and solely when in essentially unperturbed conditions, since deviations between theoretical predictions and exponential evidence begin to be significant for the helium and become embarrassing for heavy atoms such as the zirconium because of a basic reason for the proposal to construct hadronic mechanics, the emergence of nonlocal, nonpotential and non-Hamiltonian effects between atom,ic electrons that begin precisely with the helium. When all atoms, including the hydrogen, are exposed to extreme conditions of pressures as occurring in stars,m these nonlocal, nonpotential and non-Hamiltonian effects are dramatically increased, resulting in dramatic deviations between the theoretical predictions based on quantum mechanics and the experimental evidence.

Along these lines, the author suggest the conduction of quantitative studies on the *origin of the energy in supernova explosions*. As it is well known (se, e.g., Ref. [75] and large references therein), the sequence of a supernova is currently expected to be due to the exhaustion of the "nuclear fuel" in a star resulting in an expected iron core that, when reaching the Chandrasekar mass, collapses all atoms into into a neutron star, at which point contraction stops with the initiation of the explosion.

This produces one of the most violent explosions in the universe that are visible to the naked human eye on Earth as far away as tens of thousands of light years away estimated to require about 10^{50} joules of energy, namely., an amount of energy hardy comprehensible by mankind.

The issue in which the author would like to attract the attention of young mind of any age outside academic political and theological rings is that this huge energy is quickly "interpreted" as being provided by the the energy conversion of about 10 % of the original star mass. However, the *mechanism* of energy production is ignored, evidently because it is based on the synthesis of the neutron that, notoriously, cannot be treated via quantum mechanics, thus resulting in vague indications or theological feelings.

In fact, *at the time of reaching the state of a neutron star, there are no appreciable nuclear syntheses that can possibly account for the production of such un-imaginable amount of energy*. Hence, one [possibility that should be investigated, of cpourse, jointly with others, is that *the energy in a supernova may originate prior to the explosion, namely, during the formation of the neutron star*.

If the above arguments are admitted as part of others, potentially momentous advances are possible. In fact, we have recalled above that *the synthesis of the neutron does not release any energy and actually requires 0.78 millions electron Volts*.

Hence, the issue is addressed is: *where is the enormous amount of energy required to reach a neutron star originating from?* The issue brought to the attention of young minds of any age is the following:

SUPERNOVA HYPOTHESIS: The energy needed for a supernova explosion originates at least in part from space conceived as a universal medium of very high energy density (Section 6.1.2).

In the next section we shall study the synthesis of the neutron inside stars as solely permitted by hadronic mechanics in a quantitative, numerical. and in variant way. It is evident that, as a first possibility, the missing 0.79 MeV originates from the thermal and other energies available inside a star, are acquired by the proton and the electron during "Rutherford's compression" of the hydrogen atom, and result in the synthesis of the neutron.

However, a scientific process cannot be claimed unless the studies include the alternative possibility that *the synthesis of the neutron inside a star is a mechanism of transfer of energy from space to matter, namely, a mechanism for continuous creation of matter in the universe.*

To conduct science as traditionally conceived, that via a quantitative and invariant ;process verifiable in laboratory, we have to halt at this point our study of supernova and defer interested reader to a study of the next section.

6.1.14 Verifications via the Bose-Einstein Condensation

The *Bose-Einstein condensation* (see, e.g., Refs. [76-78]) is one of the most mysterious events in nature that could stimulate major advances in scientific knowledge, under the condition that the memory of Satyendra Nath Bose and of Albert Einstein is indeed duly honored, but the limitations of their view is admitted as the premise the same advances, the belief in final theories being solely motivated by money, prestige and power.

There is no doubt that the initial experimental realization of the Bose-Einstein condensation can be fully treated with special relativity and quantum mechanics. However, there should be no doubt by serious scientists that its extreme realization includes *contact, zero-range, nonlocal and non-Hamiltonian interactions extended over the volume of deep wave-overlappings of the atomic electrons at short distances.*

The *approximate* character of special relativity and quantum mechanics for these novel interactions is beyond scientific doubt. By contrast, isorelativity and hadronic mechanics are the only theories known to the author that:

1) Provide an axiomatically correct representation on nonlocal;l interactions extended over a volume, beginning with the basic TSSFN isotopology specifically constructed for the interactions considered (Section 3.2.7);

2) Is "directly universal" for nonlocal and non-Hamiltonian interactions in the sense of admitting all infinitely possible interactions of the class admitted ("universality") directly in the frame of the experimenter, thus without the transformation to hypothetical frames ("direct universality"); and

3) It enjoys the same invariance of quantum mechanics, namely, admitting the same numerical predictions under the same conditions but at different times.

The conditions of applicability of relativistic hadronic mechanics to the Bose-Einstein condensation are those in which, under a sufficiently strong external magnetic field, the condensate enters into the attractive phase , shrinks beyond detection, and then explodes, by blowing off part of its atoms, the remaining parts essentially disappearing from detection.

It is known that this characteristic of BoseEinstein condensate cannot be explained with special relativity and quantum mechanics because of the evident impossibility to account for the *strongly attractive force between neutral atoms*

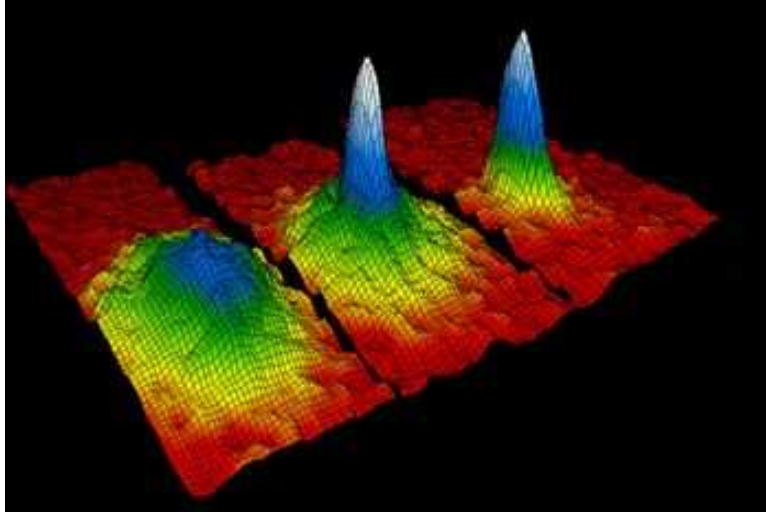

Figure 6.18. A typical illustration of the Bose-Einstein condensation from Ref. [76] showing the velocity distribution of gases: just before the appearance of the Bose-Einstein condensate (left); just after the appearance of the condensate (center); and a representative sample of nearly pure condensate (right). The most intriguing event is the subsequent one with a "supernova-type behavior" that could activate an interplay between matter and space as a universal substratum of extremely high energy (Section 6.2).

that is needed for an implosions such to allow the condensate to disappear from measurements. Secondly, there is no possibility of explaining via quantum mechanics the *super-nova type behavior* of the condensate following the impletion.

Relativistic hadronic mechanics offers the possibility for a quantitative study of the above anomalous behavior. In fact, we shall study in detail in the next section that *nonlocal interactions due to wave overlappings at short distances in singlet couplings generate a strongly attractive force* that can be responsible for the synthesis of hadrons.

Additionally, relativistic hadronic mechanics offers means for quantitative studies as to whether the excessive energy needed for the super-nova phase of the condensation originates from space conceived as a universal medium of very high energy density. As we shall also see in the next section, iso-Hilbert spaces have been also conceived for a quantitative representation of the interplay between matter and the ether as a universal medium.

Stated in different terms, once the limitations of orthodox doctrines are admitted as the very premise for basic advances, the Bose-Einstein condensation could have such far reaching implications of allowing experimental means for ascertaining whether the same mechanism occurs for supernova explosions or, more

generally, whether or not there is indeed continuous creation of matter in the universe./

6.1.15 Verification in Cosmology

In preceding chapters, we have studied the various branches of hadronic mechanics consisting of methods for the representation of matter in conditions of progressively increasing complexity, such as

QUANTUM MECHANICS, representing isolated, reversible and single-valued systems of point particles under solely Hamiltonian interactions;

ISOMECHANICS, representing isolated, reversible and single-valued systems of extended, nonspherical and deformable particles under Hamiltonian and non-Hamiltonian interactions;

GENOMECHANICS, representing open, irreversible and single-valued systems of extended, nonspherical and deformable particles under Hamiltonian and non-Hamiltonian interactions;

HYPERMECHANICS, representing open, irreversible and multi-valued systems of extended, nonspherical and deformable particles under Hamiltonian and non-Hamiltonian interactions.

We have then studied the isodual images of all preceding four methods for the treatment of antimatter in conditions of corresponding, progressively increasing complexity.

These studies include the geometric unification of special and general relativity into isorelativity, their basic Poincaré-Santilli iso-, geno-, and hyper-symmetries, and the axiomatically consistent classical and operator gravity embedded in the basic unit.

For the purpose of this section we note that all distinctions between matter and antimatter are lost at the hyperstructural level, thus permitting a unification of *all* branches of hadronic mechanics into one single formulation, hypermechanics, admitting all other as particular cases. In fact, the hyperunit can be characterized by an ordered set of genounits and their isoduals,

$$\{\hat{I}\} = \{\hat{I}_1^>, \hat{I}_1^{>d}, <\hat{I}_1, <\hat{I}_1^d, I_2^>, <I_2^{>d}, \hat{I}_2, <\hat{I}_2^d, \dots\}, \quad (6.1.126)$$

under which the hyperproduct of two generic quantities a and b yields a corresponding ordered set of values

$$a\{\times\}b = \{c_1^>, c_1^{>d}, <c_1, <c_1^d, c_2, c_2^d, <c_2, <c_2^d, \dots\} \quad (6.1.127)$$

Consequently, at this highest possible level of formulation, we have one single hyperrelativity, one single Poincaré-Santilli hypersymmetry

$$\{\hat{P}\}(3.1) = \hat{P}_{matter}^{>}(3.1) \times \hat{P}_{antimatter}^{>d}(3.1) \times <\hat{P}(3.1) \times <\hat{P}^d(3.1). \quad (6.1.128)$$

and one single hypergravity encompassing all particular cases of exterior and interior, classical and operator gravitation for both matter and antimatter.

The above defined hypermechanics have permitted the formulation of a *new cosmology*, first proposed by Santilli in Ref. [79], and now known as *hypercosmology* characterized by the following three basic assumptions:

HYPERAXIOM I: The universe is (3+1)-dimensional and multi-valued.

HYPERAXIOM II: All events in the universe verify the Poincaré-Santilli hypersymmetry.

HYPERAXIOM III: All total physical characteristics of the universe are identically null.

A few explanatory comments are in order to assist the non-initiated reader. As studied throughout Volume I, the sole possibility known to the author of achieving a consistent *classical* treatment of antimatter that verifies all experimental data and admits charge conjugate operator images, is given by the isodual theory. This theory implies that *the universe is (3.1)-dimensional but two-valued*. In fact, antimatter does indeed exist in a (3.1)-dimensional space, but the isodual conventional, iso-, geno, or hyper-Minkowski space is *different* than the conventional space of matter. This leads to a two-valued structure of the universe, namely, a structure consisting of two coexisting worlds, in which each of the (3.1) components has two values, one for matter with unit +1 and one for antimatter with unit -1.

The extension from the two-valued matter-antimatter spacetime to a multi-valued universe is dictated by numerous aspects, not only in astrophysics, but also in biology where multi-valuedness is necessary to attempt any minimally credible study of biological structures such as the DNA code whose complexity is beyond human imagination at this time (Chapter 5)

Note in covering structures (6.1.126)-(6.1.128) the presence of *all* possible formulations, namely: formulations for the description of matter systems moving forward and backwards in time and their isoduals for antimatter. This all encompassing generality is dictated, certainly not by elementary systems familiar to physicists, but by the complexity of the biological world that is beyond the imagination of the most educated biologist.

We have indicated in Chapter 1.5 that a credible representation of a truly elementary biological event, such as the bifurcation achieved by seashells during their growth in time, requires *all four directions of time, that is: motion forward in future time; motion forward from past time; motion backward from future time; and motion backward in past times*. Then, the most skeptic of a reader cannot deny the necessity of our isodual theories without risking a credibility collapse due to ignorance, for the evident reason that *time reversal can only achieve two out of four time directions, while the remaining two can be only achieved only via isoduality in a way compatible with classical and operator experimental*

evidence. Alternative conjugations are encouraged, provided that they are not merely epistemological, but quantitative and published in refereed journals, and with the understanding that they will remain redundant over isoduality [83].

The reader should be aware of the *dramatic differences between multi-dimensional and multi-valued theories.* Multidimensional theories are herein defined as being characterized by a number of spacetime dimensions bigger than (3.1), such as (4.1, (3.3), etc. These theories, even though at time mathematically elegant, are herein strictly rejected on physical grounds because directly incompatible with our sensory perception that, as well known, is based on our three Eustachian lobes solely permitting a three-dimensional perception of space, and our one-dimensional perception of time.

By contrast, our multi-valued theories have been conceived and developed to achieve full compatibility with our sensory perception, while admitting a complexity of the universe beyond our imagination. As an example, when we observe a seashell in our hand, we perceive its shape in three-dimension and its evolution along our one-dimensional time. However, the same seashell can overlap a large number of spaces and their isoduals, resulting in multi-fold formulations including the four different directions of time indicated above. To state it differently, the assumption that the internal time of a seashell is necessarily the same as our time can only originate from arrogance of planetary proportions. The sole scientific statement we can venture at this writing is that the intrinsic time of a seashell is of such a complexity to be beyond our rather limited mental capabilities.

In Section 1.4., the author has shown that general theory of relativity is catastrophically inconsistent on mathematical and physical grounds for numerous diversified reasons, some of which are nowadays vexing because untreated (let alone unresolved) for about one century, while other reasons have emerged from these studies (see the *Nine Theorems of Catastrophic Inconsistencies of General Relativity* of Ref. [73]).

In the author's view, the biggest damage caused to science by general relativity has been in turning cosmology into a theology (see Appendix 6.D). One, among numerous reasons, is the structuring of gravitation on on *covariance* that leads to the impossibility of preserving the same numerical predictions under the same conditions at different times, the violation of causality, and other catastrophic inconsistencies. This is a reason for the author spending decades of his time in reformulating gravitation on a *universal symmetry* [5] as the only known way to avoid these catastrophic inconsistencies, as per historical teaching of special relativity.

The foundation of our hypercosmology on the universal hypersymmetry (6.1.128) is the single most important result of the author's lifetime of research because it governs the totality of the events in the universe, from large scale cosmological dynamics, down to the most elementary component of the universe. The clear

understanding is that we are here merely referring to a *model* that, as such, has numerous limitations, some of which are identified below, for science will never admit a "final theory."

One illustration of the theological aspect of the cosmological studies of the 20-th century is the large effort devoted to the *age of the universe* without a serious scrutiny of the limitations in the very formulation of the problem. The origin of these problems remains always the widespread studious tendency of adapting nature to Einsteinian theories.

But, as established in Chapters 1.1 and 1.2, Einsteinian theories have no *classical* mean at all to differentiate neutral matter and antimatter stars; the only differentiations available in the 20-th century being that at the level of *second quantization*; and general relativity admitting no consistent formulation at the level of *first* quantization, let alone the second. As a result of this vast scientific imbalance, in order to adapt nature to Einsteinian theories, antimatter has been intentionally ignored in the gravitational and cosmological studies of the 20-th century and the "age of the universe" has been studiously referred to matter alone, "studiously" because the antimatter component of the universe is generally *not* mentioned.

The reader who has studied seriously the content of Volume I before a quick glance at this section knows well that *the the total time of the universe is identically null for an equal distribution of matter and antimatter*, that is implicit in hyperaxiom III, of course, as a limit case.

Even by restricting the study to *the age of the matter component of the universe and, separately, the antimatter component*, there are insufficiencies in the very formulation of the "age of the universe," let alone on a possible answer, because such a question is tacitly based on the assumption of Einsteinian theories as being universally valid everywhere in the universe.

If, instead, broader vistas are admitted as possible, the problem of the age of the matter component of the universe, or its antimatter component becomes rather complex because of the *strictly local character of each of the four different times*, where the locally varying character *not* referred to gravitation, but to *the local variation of the four different time units* that include indeed gravitation, but in its *interior* formulation.

Once the initiated reader has technically understood that the total time of the universe under an equal distribution of matter and antimatter can only be identically null, then the reader can easily see that: *the total energy, the total momentum, the total angular momentum and all other characteristics of the universe are identically null* (see Volume I and Ref. [83] for technical details).

Yet another reason for the theological character of the cosmological studies of the 20-th century is the belief that the universe initiated with an *immense singularity* in the fabric of spacetime, called the "big bang" without a serious

scrutiny of its foundation. To begin, the primordial explosion is tacitly referred to solely to matter. Antimatter is studiously ignored because not treatable with Einstein's gravitation and, consequently, it is tacitly assumed not to exist. By contrast, *the mere inclusion of antimatter would eliminate the singularity in the act of creation, evidently because the total characteristics of the universe were identically null prior to creation and so remain after creation.*

But the problem of the origin of the universe is of such a complexity to be immensely beyond our comprehension, thus demanding the only statement for true science, we do not know, and no certain answer is foreseeable at this writing. To illustrate the need for serious scientific caution, we have touched in the preceding sections the possibility of *continuous creation* of matter, hence of antimatter, in the universe, and we shall enter into its quantitative studies beginning from the next section on.

It is evident that a possible continuous creation of matter in the universe renders arrogant any questions such as that on the "the age of the universe." At any rate, the author is a religious person, because the complexity of the universe is simply too enormous to be the outcome of random occurrences. The addressing of issues such as "age of the universe," the "creation of the universe," etc., indicate lilliputian intellect, because tacitly based on the unspoken, yet evident assumption of a capability to understand God's will. This is a reason for presenting our cosmological views more for the identification of the insufficiencies of existing views, rather than because actually true.

Other unreassuring cosmological studies are those on the apparent *expansion of the universe*. To begin, the views are essentially based on the Einsteinian interpretation of cosmological redshift as being due to motions away from us. However, we have shown in preceding sections that, subject to final experimental verification strongly requested in the next section, *light can indeed slow down in the huge astrophysical chromospheres, thus being emitted already redshifted even for the case of astrophysical bodies at rest with us.* Hence, the current measurements on cosmological redshifts are indeed "actual," but their interpretation down to expansion speed are merely conjectural, again, because based on Einsteinian beliefs.

The author's view is that the "notion of expansion" of the universe appears to be supported by a number of direct or indirect astrophysical evidence, although the "numerical rate of expansion" is at this writing a mere personal belief due to the lack of experimental verifications of the Doppler-Santilli isoredshift rejected by astrophysical laboratories for decades, evidently not to question Einsteinian theories.

Additional unreassuring aspects are related to the origin of the expansion because antigravity would be a natural origin, but, according to a widespread view, "antigravity does not exist because not admitted by Einsteinian theories." Such a

view must be denounced as sheer scientific corruption for personal gains in money, prestige and power, because Einsteinian theories do not even represent antimatter, as a consequence of which any study of antigravity via Einsteinian theories is entirely vacuous. In reality, *the most plausible understanding of the expansion of the universe known to the author is that the universe is constituted by a generally homogeneous distribution of matter and antimatter galaxies experiencing mutual gravitational repulsion as studied in detail in Chapter 13.*

To be plausible, the interpretation should not only explain the *expansion per se*, but also the apparent *increase of the expansion in time*. These two occurrences cannot possibly be explained with the "big bang" since the expansion should decrease, rather than increase in time due to the "dark matter wind" that is inherent in orthodox theological beliefs). The increase of the rate of expansion can be *solely* explained via the existence of a *continuous, action-at-a-distance, repulsive force between galaxies*. In turn, the only conceivable possibility verifying these conditions is *antigravity*, and, in turn, the only known source of gravitational repulsion is *antimatter*.

We reach in this way the expectation of the existence of antimatter stars, galaxies and quasars, this time derived as the only plausible interpretation of the gravitational expansion *and* its increase in time. Unreassuringly, the author has been informed that numerous astrophysical events can only be interpreted quantitatively via antigravity, but such an interpretation cannot be voiced (or published) because antigravity is not predicted by Einsteinian doctrines.

As indicated in Volume I, the isodual theory of antimatter has been worked out because it provides, for the first time to the author's knowledge, quantitative mathematical, theoretical and experimental possibilities of ascertaining whether a far away galaxy or quasar is made up of matter or of antimatter, not only via unbiased astrophysical observations requiring antigravity, but also via unbiased interferometric studies of the light originating from galaxies and quasars to ascertain whether they it is composed by *ordinary photons*, or by *isodual photons*. The former is *attracted* by Earth's gravitational field, while the latter is *repelled*, thus rendering current interferometric techniques suitable for the detection or the denial of antimatter in the universe [83].

We should not forget that, according to unbiased reports, Earth appears to be bombarded by cosmic rays of both matter and antimatter nature, as indicated by flashes of light visible from spaceships while traversing the dark side of Earth. These flashes can be best interpreted as being due to *antimatter cosmic rays* annihilating in our atmosphere, and certainly not by *matter cosmic rays* since the latter are known to penetrate deeply into our atmosphere and definitely not to annihilate in it.

To avoid adapting nature to preferred theologies, we should not forget that the *Tunguska explosion* in Siberia in June 30, 1908, can be most plausibly explained

via an *antimatter meteorite* penetrating deep into the Earth's atmosphere and then exploding due to annihilation. This interpretation is suggested by the lack of a crater in the Tunguska event, despite a huge flattening of the local forest for over hundreds of square miles. By comparison, the hypothesis of a *matter meteorite* has no credibility since the lack of a crater would require its believed "evaporation" (sic) in atmosphere, namely, an occurrence firstly denied by all other craters caused by matter meteorites and, secondly, because the "evaporation" would have not even part of the energy needed for a scientific, that is, numerical explanation of the event.

Hence, antimatter is a most fundamental aspect of cosmology that has been forgotten during the physics of the 20-th century, to the evident detriment of researchers in the field, since their study cannot possibly pass the test of time without a full scientific democracy between matter and antimatter. It is hoped that this unreassuring trend is corrected in the 21-st century because true science cannot be done with theological beliefs or the adaptation of nature to preferred theories, but solely via the unbiased mathematical, theoretical and experimental study of *all* plausible theories, irrespective of whether compatible or not with Einsteinian doctrines

To fully understand this statement, the reader should know that, as we shall see in the final Chapter 14, all grand unification theories done throughout the 20-th century, beginning with the failed attempts by Einstein, can be proved rather easily to be catastrophically inconsistent on the sole ground that they do not include antimatter.

In closing, to keep a kilometric distance from orthodox trends, the author would like to stress that his hypercosmology has been presented as a sheer exercise of scientific curiosity without any claim of "scientific truth, and for the sole intent of showing the limitations of pre-existing cosmologies.

The author solely claims (and will defend, see the Legal Notice at the beginning of this volume) paternity of the first "cosmology" in the Greek meaning of the word, that is, including all structures in the universe, and thus *include life*, for that inclusion alone mandates all studies reported in these volumes.

6.2 HADRONIC STRUCTURE MODELS WITHOUT QUARKS AND NEUTRINOS

6.2.1 Introduction

Hadronic mechanics (hm) was proposed in memoirs [14] of 1978 for the primary purpose of achieving an exact and invariant representation of the neutron as a bound state of one proton and one electron, of course, in a generalized form (hereinafter denoted with a "hat")

$$n = (\hat{p}^+, \hat{e}^-)_{hm}. \quad (6.2.1)$$

The first rational basis for the proposal is that the proton and the electron are the only massive stable particles existing in nature. Hence, during the synthesis of the neutron in the core of stars from the hydrogen atom, the proton and the electron simply cannot "disappear" to please academicians. Consequently, the most rational assumption is that they are actual physical constituents of the neutron.

The second rational basis of the proposal is that the proton and the electron are reproduced in the *spontaneous* decay of the neutron and, as such, they simply cannot "reappear" to comply with preferred theories. Since the creation of the only known massive stable particles at the time of the neutron spontaneous decay is extremely implausible, the most rational assumption is that, again, the proton and the electron are actual physical constituents of the neutron.²⁹

It is evident to undergraduate students that structure model (6.2.1) is impossible for quantum mechanics. Rather than adapting nature to preferred theories, memoirs [14] suggested adapting the theories to nature via the construction of a generalization of quantum mechanics permitting models (6.2.1).

The proposal was based on a *nonunitary transformation* of quantum mechanics (qm), as a necessary condition to exit the classes of equivalence of quantum mechanics under *unitary transforms*. The nonunitary structure was also proposed in view of the fact that, in the transition from the hydrogen atom to the neutron in the core of stars, we have the transition of the electron from the state of a point particle moving in vacuum with sole action-at-a-distance interactions, to the state of an extended wavepacket in condition of total penetration within the hyperdense medium inside the proton. The latter conditions characterize new, contact, nonlinear, nonlocal and nonpotential interactions dramatically beyond the representational capability of a Hamiltonian. The inability of representing

²⁹The author experiences great difficulties in reading the particle physics literature of the 20-th century because of the presentation of particle reactions in which new particles are created without any explanation whatsoever. This posture is generally intentional to claim the validity of quantum mechanics in particle physics, since its insufficiency becomes crushing when the mechanisms creating new particles are addressed quantitatively.

the neutron synthesis with the sole knowledge of the Hamiltonian, then confirmed the need for a nonunitary theory.

Hence, memoirs [14] proposed the construction of a nonunitary image of quantum mechanics permitting a consistent map of the hydrogen atom H into the neutron exactly as occurring in the core of stars,

$$H = (p^+, e^-)_{qm} \ ; \rightarrow \ n = (\hat{p}^+, \hat{e}^-)_{hm} = U_n \times (p^+, e^-)_{qm} \times U_n^\dagger, \quad (6.2.2a)$$

$$U_n \times U_n^\dagger \neq I. \quad (6.2.2b)$$

The neutron was proposed as essentially being a new state of the hydrogen atom solely occurring at mutual distances of the order of $10^{-13}cm = 1 \text{ fm}$, the hydrogen atom obeying quantum mechanics and the neutron obeying the covering hadronic mechanics. Requirement (6.2.2) then imposed *ab initio* that hadronic mechanics is solely valid at mutual distances of particles of the order of one fm, namely, for the range of strong interactions. Equivalently, map (6.2.2) requires that the excited states of the neutrons are the quantized states of the hydrogen atom, or, alternatively, that

$$Lim_{r>1fm}(U_n \times U_n^\dagger) = I. \quad (6.2.3)$$

It was stressed in memoirs [14] that quantized orbits do exist for point particles moving in vacuum, as in the hydrogen atom, but the belief of the existence of tiny quantized orbits within the hyperdense medium inside the neutron would be pure nonscientific nonsense. This prevented in refs. [14] for ethical reasons the use of the word "quantum" for the new discipline. The name "hadronic mechanics" was selected to stress the primary intent of the new mechanics, the study of the hadronic structure or, more generally, of strong interactions.

Since quantized orbits are represented by the *basic unit of quantum mechanics*, Planck's constant $I = \hbar$, the absence of quantized orbits inside the neutron mandated a generalization, called *lifting*, of the Planck's constant into a Hermitian and positive-definite, but otherwise arbitrary, integro-differential operator \hat{I} . In the same way as the synthesis of the neutron is the most fundamental event in nature, its mathematical representation required the lifting of the most fundamental mathematical quantity, the basic unit, namely, synthesis (6.2.2) requires the following lifting of Planck's constant

$$U \times U^\dagger = U^\dagger \times U = I = \hbar \rightarrow U_n \times U_n^\dagger = \hat{I}_n = \hat{I}_n^\dagger = \hat{I}_n(r, p, \psi, \partial_r \psi, \dots) > 0, \quad (6.2.4)$$

with the subsidiary condition following from Eq. (6.2.3)

$$Lim_{r>1fm}\hat{I}_n = I = \hbar, \quad (6.2.5)$$

Since a mathematics based on an arbitrary (nonsingular) unit simply did not exist in 1978, all branches of mathematics had to be rewritten in such a form

admitting \hat{I} , rather than I , as the left and right unit at all levels. This mandated the lifting of: numbers; fields; functional analysis; topology; differential calculus; enveloping associative algebras; Lie algebras; Lie groups; Lie symmetries; Lie representation theory; Euclidean, Minkowskian, symplectic, Riemannian and other geometries; etc. These liftings illustrate the need for decades of research in pure mathematics prior to being in a position of doing serious quantitative studies on the synthesis of the neutron. The occurrence also illustrates the dimension of the resulting works (consisting of over 20,000 pages of published research by hundreds of authors outlined in the General Bibliography) of which we can regrettably touch in this section only the most salient lines.

This huge effort was motivated not only by scientific curiosity, but also by the alarming environmental problems afflicting our planet, which problems were already clear in 1978, even though irrationally dismissed. As already well known in 1978, the resolution of our environmental problems requires new clean energies and fuels. As equally known in 1978, all possible energies and fuels conceivable with quantum mechanics and special relativity had been fully discovered by that time, and all turned out to be environmentally unacceptable. The only hope for society was then the construction of suitable *generalizations* of quantum mechanics and special relativity that would at least permit the conception of new clean energies and fuels. This need provided the author the necessary strength to trash out academic putrescence and its organized opposition against the construction of hadronic mechanics denounced in the footnotes of these volumes.

In fact, if (and only if) the electron is an actual physical constituent of the neutron, then (and only then) the neutron could be stimulated to decay via resonance and/or other mechanisms, thus initiating a it new class of energies called *hadronic energies*, because different than nuclear, atomic and molecular energies and originating from mechanisms in the structure of individual hadrons, rather than in their collection. Unlike nuclear energies, the latter are expected to exist for *light nuclei*, thus being "clean" in the sense of not having sufficient energy to release harmful radiations and/or leave harmful waste, as we shall see in Chapter 11.

The extension of model (6.2.2) to some of the other baryons is elementary, e.g.,

$$\Lambda = (\hat{p}^+, \hat{\pi}^-)_{hm} \equiv (\hat{n}, \hat{\pi}^o)_{hm}, \quad (6.2.6)$$

where the reader should keep in mind the equivalence on iso-Hilbert spaces of particles that are distinct on conventional Hilbert spaces, due to internal non-Lagrangian / non-Hamiltonian exchanges and renormalizations we shall indicate in this section.

Additionally, memoirs [14] worked out in details (see Ref. [14b], Section 5) the representation of *all* characteristics of the π^o meson as a hadronic bound state of

an electron and a positron, although in their isotopic form

$$\pi^o = (\hat{e}^+, \hat{e}^-)_{hm}. \quad (6.2.7)$$

Much along lines (6.2.2) for the neutron, the above model was proposed as a nonunitary image of the positronium P

$$P = (e^+, e^-)_{qm} \ ; \rightarrow \ \pi^o = (\hat{e}^+, \hat{e}^-)_{hm} = U_{\pi^o} \times (e^+, e^-)_{qm} \times U_{\pi^o}^\dagger, \quad (6.2.8a)$$

$$U_{\pi^o} \times U_{\pi^o}^\dagger = \hat{I}_{\pi^o} > 0 \quad (6.2.8b)$$

where the reader should note from these introductory lines that quantum mechanics admits one and only one unit, Planck's constant. while hadronic mechanics admits *different isounits for different particles*, trivially, because the isounit represents contact non-Hamiltonian effects that are different for different particles.

Recall that the positronium is entirely described by one single equation, Schrödinger equation. Similarly, the nonunitary map (6.2.8) yielded *one single hadronic structure equations representing "all" features of the π^o* , including rest energy, charge radius, meanlife, charge, spin, magnetic moments, parity and spontaneous decay, the latter identifying the actual physical constituents.

Memoirs [14] then worked out the model for other mesons, resulting in "bootstrap" models of the type

$$\pi^\pm = (\hat{e}^+, e^\pm, \hat{e}^-)_{hm} \equiv (\hat{\pi}^o, \hat{e}^\pm)_{hm}, \quad (6.2.9)$$

whose spontaneous decay identifies, again, the actual physical constituents, This decay is called *hadronic tunnel effect*, in the sense that the tunneling occurs through Hamiltonian and non-Hamiltonian barriers.

The radical departures from orthodox trends of the above structure models of unstable hadrons should be noted upfront, such as:

1) The new structure models are absolutely impossible if attempted via the use of quantum mechanics for countless reasons, some of which will be identified in this section;

2) The new structure models have no need whatsoever of quark and neutrino conjectures as also shown in detail in this section; and

3) Eliminate for the structural problem the widespread tendency of looking for the "mass spectrum," a feature allowed only for classification, a point emphatically stressed in memoir [14]. In fact, nonunitary maps (6.2.2) and (6.2.8) were identified under the condition of being *spectrum suppressing*, namely, the generalized Schrödinger equation for a hadron had to characterize one state and one state only, the hadron considered, trivially, because all excited states are conventional quantum, thus atomic states, under limits (6.2.5).

The above radical departures from rather universal trends of the time (1978) require the following comments. In essence, hadron physics of the 20-th century

was dominated by the belief that the mechanics exactly valid for the description of point-like electrons moving in vacuum around atomic nuclei was also exactly valid for the description of the same particles moving within the hyperdense media inside hadrons.

Such a belief led to scientific imbalances of historical proportions studied in Volume I and in the preceding section. The conjecture that quarks and neutrinos are physical particles in our spacetime was a mere consequence of adapting the hadronic structure to a preferred theory. The outcome was a plethora of fundamental problems that remained unresolved, because un-dressed due to the widespread illusion of achieving credibility via the academic power of the affiliations and physical societies, rather than serious scientific evidence.

To minimize misrepresentations of the intent of this section, it should be stated upfront that *we fully accept the validity of the standard model and of the theory of weak interactions*. However, we restrict their validity to an *external*, Mendeleev-type treatments of hadrons; we deny their additional role as providing a joint representation of both, the classification and the structure of hadrons; and, by following the historical teaching for nuclei, atoms and molecules, *we seek basically new models of the hadronic structure with ordinary massive physical constituents under the condition of achieving compatibility with the established, external, Mendeleev-type theories*.

It should be noted that the new structure model of unstable hadrons did not require the addressing of the neutrino conjecture for the case of mesons and, consequently, could be worked out in its entirety already in the original memoirs [14] under the sole denial of quarks as physical particles in our spacetime. In this section, we shall review *ad litteram* the new structure model for mesons as originally conceived in 1978 by leaving additional advances to interested readers.

The explicit construction of the corresponding new structure model of unstable baryons with ordinary massive physical constituents was delayed for decades because of technical and political reasons. On technical grounds, the use of hadronic mechanics for baryons required the isotopic lifting of the $SU(2)$ -spin symmetry that was unavailable at the time of the original proposal [14] (that, however, did contain the isotopies of the $O(3)$ -symmetry). The first nonrelativistic structure model of the neutron as a bound state of a proton and an electron appeared in ref. [95] of 1990 following the isotopies of the spin symmetries (see Refs. [5]). Its relativistic extension appeared in papers [5f,96] only following the achievement of the isotopies of the spinorial covering of the Poincaré symmetry in ref. [5f].

The political difficulties were caused by the fact that the belief in neutrinos as physical particles was, and remains to this day, much more entrenched in the mind of physicists than the corresponding belief for quarks. Consequently, all papers on the new structure model of the neutron and with the additional denial that neutrino as physical particles caused incredible oppositions, at times even hyster-

ical. These oppositions delayed considerably the scientific process and caused a somewhat unusual scientific situation in which, on one side, editors and reviewers mandated the maintaining of the neutrino conjecture while, on the other side, hadronic structure models did not required such a conjecture at all. This explains the presence of the neutrino conjecture in paper [95,96].

The controversies on the nature of the neutrino delayed this volume for at least ten years since it was repugnant for us to complete a lifelong research with political postures. A determining event occurred at the 2006 meeting of the *International Association for Relativistic Dynamics* (IARD) held at the University of Connecticut, in Storrs. During this meeting the participants allowed the author to express his doubts on the existence of the neutrinos as physical particles. The author has no words to express his appreciation and gratitude to all IARD members for their tolerance of dissident views, as well as his sincere respect for their commitment to true scientific democracy for qualified inquiries. Said tolerance by IARD's colleagues gave the author sufficient motivation to initiate the completion of this second volume.

The final decision to initiate the release of this volume was permitted by M. van der Merwe, Editor of Foundations of Physics for the first publication by the author [97], following four independent reviewers, with systematic doubts on the existence of the neutrinos as physical particles in our spacetime. This paper also contains considerable references of similar publications by dissident colleagues. Because of this publication, as well as numerous others by the author (such as the first paper with systematic doubts on the existence of quarks as physical particles, Ref. [88] of 1981), and numerous other pioneering works by other authors, M. van der Merwe was recently granted a Gold Medal for Scientific Merits to be granted in 2008.

As historical notes, we should recall that quantum mechanics was called "atomic mechanics" in Ref. [14], namely, a mechanics conceived and constructed for the atomic structure, in order to distinguish it from "hadronic mechanics," namely, the mechanics conceived and constructed for the hadronic structure. This terminology has been lost with the passing of time. but remains still valid as of today.

Also, electrons were said to be *mutated* when within the hyperdense medium inside hadrons, to reflect a corresponding mutation in Ref. [100] of Lie algebras into covering Lie-isotopic or Lie-admissible algebras. This dual particle and algebra meaning of the word "mutation" has remained in use and will be adopted in this section under the assumption that covering algebras are treated with new mathematics to bypass the Theorems of Catastrophic Inconsistencies of Nonunitary Theories (Section 6.1.6).

Finally, mutated electrons and positrons were called in Ref. [14] "eletons" and "antieletons," respectively. These terms have been replaced with the corre-

sponding terms used in this section, namely, "isoelectrons" and "isopositrons", or "isodual isoelectrons" to denote the fundamental symmetry for the characterization of their mutations, the Poincaré-Santilli isosymmetry and its isodual [5].

Needless to say, due to the extreme complexity of the problem, this section includes the use of the *totality* of the preceding studies on hadronic mechanics as per classification of Figure 1.22. Readers with a vast knowledge of quantum mechanics but insufficient knowledge of the covering hadronic mechanics are discouraged from glancing at this section to prevent the illusion of its understanding.

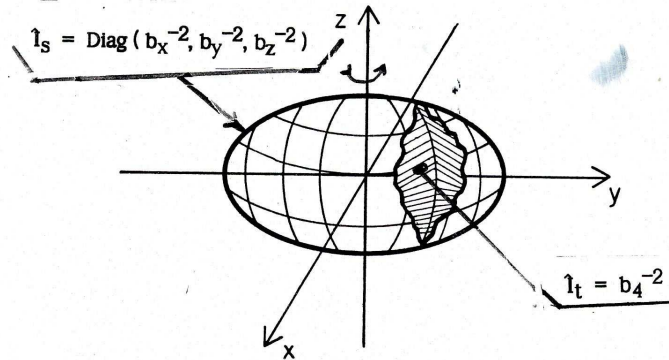

Figure 6.19. A schematic view of one of the various physical meanings of the characteristic quantities defined by isorelativity and hadronic mechanics, the representation of the actual *share* of the particle considered via the space components $b_k^2 = 1/n_k^2$, $k = x, y, z$, here depicting a spheroidal ellipsoid for simplicity (see EHM-II for other shapes represented via nondiagonal isounits), and the representation of the *density* via the fourth component $b_4^2 = 1/n_4^2$, all normalized to the values 1 for the vacuum. Note that these representations do not exist in the mathematics and physics of the 20-th century, trivially, because structurally beyond any hope of representation via a Hamiltonian. Orthodox interests claim that the characteristic quantities are "free parameters." The political nature of such a claim is unmasked by noting that its acceptance requires the belief that the size and mass of hadrons are also free parameters. As we shall see in the next chapter from neutron interferometric measurements, the nonspherical and deformable shape of hadrons is *measured* quite accurately and so is the density, trivially given by the ratio between the rest energy and the volume. The confirmation that the characteristic quantities are not "free parameters" will be given in this volume by showing that their numerical values for a given particle are compatible with other tests dealing with the same particle, in the same way that, after it has been measured, the mass of the neutron cannot be changed in going from one test to another.

6.2.2 Inapplicability of Quantum Mechanics for the Hadronic Structure

Rutherford [91] submitted in 1920 the hypothesis that hydrogen atoms in the core of stars are compressed into new neutral particles having the size of the proton that he called *neutrons*, according to the synthesis



The existence of the neutron was confirmed in 1932 by Chadwick [92]. However, Pauli [93] noted that the spin 1/2 of the neutron cannot be represented via a quantum state of two particles each having spin 1/2. Fermi [94] adopted Pauli's objection and, for its resolution, conjectured the emission of a neutral and massless particle he called *neutrino* (meaning in Italian "little neutron") with symbol ν for the particle and $\bar{\nu}$ for the antiparticle. Fermi then developed the theory of *weak interactions* according to which the synthesis of the neutron is characterized by the reaction



with or complementary reaction



and inverse reaction, the spontaneous decay of an isolated neutron,



Hence, following Pauli's objection [93], Fermi [94] introduced the **neutrino hypothesis for the specific purpose of salvaging the validity of quantum mechanics for the neutron synthesis. However, Santilli proved in 1978 [14] that quantum mechanics remains basically inapplicable (rather than violated) for the neutron synthesis for various reasons, such as:**

INAPPLICABILITY 1. Schrödinger equation does not admit physical solutions for the total energy and other physical quantities for synthesis (6.2.10) because the sum of the rest energies of the proton and of the electron,

$$m_p + m_e = 938.272 \text{ MeV} + 0.511 \text{ MeV} = 938.783 \text{ MeV}, \quad (6.2.14)$$

is *smaller* than the rest energy of the neutron,

$$m_n = 939.565 \text{ MeV}, \quad (6.2.15)$$

with "positive" energy difference

$$m_n - (m_p + m_e) = 939.565 - (938.272 + 0.511) \text{ MeV} = 0.782 \text{ MeV}. \quad (6.2.16)$$

The above data would require a *positive binding energy*, under which Schrödinger equation becomes physically inconsistent because its indicial equation no longer admits real solutions (see Santilli [14], Schiff et al [98] and literature quoted therein). In fact, all consistent quantum bound states (such as those for nuclei, atoms and molecules) have a *negative binding energy* that results in the well known *mass defect* with familiar eigenvalue equation for the Coulomb bound state of two particles with the same mass in relative coordinates

$$\left(\frac{-\hbar^2}{m} \times \Delta - \frac{e^2}{r}\right) \times \psi = E \times \psi, \quad E \in R, \quad E < 0. \quad (6.2.17)$$

where m is the reduced mass. From data (6.2.14)-(6.2.16), the synthesis of the neutron would require an equation with a positive binding energy of the type

$$\left(\frac{-\hbar^2}{m} \times \Delta + |V(r)|\right) \times \psi = E \times \psi, \quad (6.2.18)$$

that is physically inconsistent, as the skeptic reader is encouraged to verify.

INAPPLICABILITY 2: In view of numerical values (6.2.14)-(6.2.16), *as written in all particle physics books of the 20-th century, synthesis (6.2.11) violates the principle of conservation of the energy* because without any specification that the l.h.s. should have the minimal kinetic energy of 0.78 MeV, in which case there is no energy left for the neutrino.

INAPPLICABILITY 3. Assuming that the proton and the electron have a relative kinetic energy of (at least) 0.78 MeV, synthesis (6.2.11) remains impossible according to quantum mechanics, because, at that value of the kinetic energy, the proton-electron cross section is excessively small (about 10^{-20} barns).

INAPPLICABILITY 4. Assuming that the above problems are somewhat resolved via a manipulation of Schrödinger equation, it is impossible for quantum mechanics to achieve a meaningful representation of:

4.1: The meanlife of the neutron of

$$\tau_n = 15m, \quad (6.2.19)$$

, since quantum mechanics would predict a meanlife of the order of 10^{-19} s;

4.2. The anomalous magnetic moment of the neutron

$$\mu_n = -1.913\mu_N \quad (6.2.20)$$

because, when computed from the magnetic moments of the proton

$$\mu_p = 2.792\mu_N \quad (6.2.21)$$

and of the electron

$$\mu_e = 1.001\mu_B, \quad (6.2.22)$$

would be wrong even in the sign; and of

4.3. The neutron charge radius

$$R = 10^{-13}cm, \quad (6.2.23)$$

since Bohr's radius $R = 10^{-8}cm$ is the smallest radius permitted by quantum mechanics for a "stable" bound state of a proton and an electron.

INAPPLICABILITY 5. The impossibility for quantum mechanics to reach a meaningful representation of the synthesis of the neutron is multiplied, rather than resolved, by complementary synthesis (6.2.12) because, being an antiparticle, the antineutrino carries a *negative* energy, rather than the needed positive energy and, in any case, the cross section of antineutrinos on protons and/or electrons must be assumed as being null for any serious study.

It should be noted that the above insufficiencies of quantum mechanics generally apply for the synthesis of all hadrons at large, beginning with that for the neutral pion

$$e^+ + e^- \rightarrow \pi^0, \quad (6.2.24)$$

where the "positive binding energy" is now of 133.95 MeV.

The above occurrences, presented in Ref. [14b] (see page 829, in particular) signaled the birth of hadronic mechanics. In fact, the author attempted for years to achieve a consistent solution of synthesis (6.2.11) via quantum mechanics. The confirmation by Cantabridgean colleagues that a consistent solution for Eq. (6.2.18) does not exist within the class of unitary equivalence of quantum mechanics, left no other choice than that of subjecting the conventional Schrödinger equation to a *nonunitary transform*, thus abandoning quantum mechanics for a covering theory.

6.2.3 Insufficiencies of Neutrino Conjectures

As it is well known, the neutrino hypothesis was more recently incorporated into the so-called *standard model*³⁰ in which the original neutrino was extended to three different particles, the *electron, muon and tau neutrinos* and their antiparticles. Neutrinos were then assumed to have masses, then to have different masses derived from the fit of experimental data, then to "oscillate" (namely, to change "flavor" or transform one type into the other), with the expectation of additional conjectures intended to bypass preceding unverifiable conjectures.

³⁰The literature in the field is so vast to discourage discriminatory listings.

Despite historical advances, the neutrino hypothesis has remained afflicted by a number of basic, although generally unspoken insufficiencies addressed in Section 1.1.2.8, and outlined as follows for the self-sufficiency of this volume:

INSUFFICIENCY 1: According to the standard model, a neutral particle carrying mass and energy in our spacetime is predicted to cross very large hyperdense media, such as those inside stars, without any collision. Such a view is outside scientific reason because already questionable when the neutrinos were assumed in being massless. The recent use of massive neutrinos has rendered the view beyond the limit of plausibility because a massive particle carrying energy in our spacetime simply cannot propagate within hyperdense media inside large collections of hadrons without any collision. The general belief that this is due to the very low value of the cross section between neutrinos and other particles casts shadows on the theory, rather than resolving the inconsistency here considered.

INSUFFICIENCY 2. The fundamental reaction for the production of the (electron) neutrino, Eq. (6.2.11), generally lacks sufficient energy for the synthesis of the neutron itself, let alone the additional energy needed to characterize the hypothetical neutrino.

INSUFFICIENCY 3. As reported in nuclear physics textbooks (see Figure 1.7), the energy measured as being carried by the electron in beta decays follows a bell-shaped curve with a maximum value of the order of 0.782 MeV (depending on nuclear data). The “missing energy” (as the difference between 0.78 MeV and the electron energy) has been assumed throughout the 20-th century as being carried by the hypothetical neutrino. However, in view of the strongly attractive Coulomb interactions between the nucleus and the electron, the energy carried by the electron is depends on the direction of emission, with maximal value for radial emission and minimal value for tangential emission (Figure 1.8). Despite a laborious search, the author has been unable to identify in the literature much needed calculations of this aspect because if the “missing energy” is entirely absorbed by the nucleus, then, again, there is no energy left for the neutrino.

INSUFFICIENCY 4. The claims of “experimental detection” of neutrinos are perhaps more controversial than the theoretical aspects because of numerous reasons, such as:

4.1 Enrico Fermi clearly stated in his writings that “the neutrino cannot be directly detected in laboratory;”

4.2. All claims of “neutrino detections” are based on a scattering theory that is basically inapplicable for deep inelastic scatterings (Figure 1.2;

4.3. The elaboration of the data via a theory centrally dependent on the neutrino hypotheses clearly implies “experimental results” compatible with the theoretical assumptions

4.4. The claims of "neutrino detections" via the selection of extremely few events over an extremely large number of events;

4.5. The presence in recent "neutrino detectors" of radioactive sources could themselves account for the extremely few events over an enormous number of total events;

4.5. The lack of clear, physically verifiable differentiations of the various neutrinos;

4.7. The lack of uniqueness of the neutrino interpretation for the interpretation of the experimental data due to the existence of alternative interpretations without the neutrino hypothesis (see Ref. [99] and references quoted therein); and other insufficiencies.

INSUFFICIENCY 5. Numerous additional insufficiencies exist, such as the theory contains an excessive number of parameters essentially capable to achieve any desired fit, and other problems [99]. In fact, the six different "neutrino masses" are *derived* from fit of the data and, as such, could merely be arbitrary *ad hoc* parameters.

For additional studies on the insufficiencies of the neutrino hypothesis, one may consult Bagge [101] and Franklin [102] for an alternative theories without the neutrino hypothesis; Wilhelm [103] for additional problematic aspects; Mössbauer [104] for problems in neutrino oscillations; Fanchi [105] for apparent serious biases in "neutrino experiments"; and literature quoted therein.

The author would like to express his deepest appreciation to Horst E. Wilhelm because his vast physical knowledge, combined with a serious commitment to scientific inquiries, and his independence of thought were instrumental for the author to release his view on the lack of existence of neutrinos as physical particles.

6.2.4 Insufficiencies of Quark Conjectures

The view expressed by the author since the birth of quark theories (see memoir [88] of 1981) is that:

I) $SU(3)$ color theories and more recently the standard model have provided the final Mendeleev-type, classification of particles into families;

II) Quarks are necessary for the elaboration of the theory, however,

III) On ground of strict scientific rigor, quarks should be solely defined what they are technically, purely mathematical representations of a purely mathematical internal symmetry solely definable on a purely mathematical, complex-valued unitary space.

Whenever quarks are assumed to be physical particles in our spacetime, numerous unresolved (and generally unspoken) insufficiencies emerge, as treated in Section 1.2.7. and outlined below for the self-sufficiency of this volume:

INSUFFICIENCY 1. According to the standard model, at the time of the synthesis of the neutron, the proton and the electron literally “disappear” from the universe to be replaced by hypothetical quarks as neutron constituents. Moreover, at the time of the neutron spontaneous decay, the proton and the electron literally “reappear” again into our spacetime. This view is beyond scientific reason, because, as pointed out in Section 6.2.1, the proton and the electron are the only *permanently stable* massive particles identified so far and, as such, they simply cannot “disappear” and then “reappear” in our spacetime just because so desired by quark supporters. The *only* plausible hypothesis is that the proton and the electron are actual physical constituents of the neutron as originally conjectured by Rutherford, although the latter view requires the adaptation of our theories to physical reality.

INSUFFICIENCY 2. When interpreted as physical particles in our spacetime, irrespective of whether we refer to mass or energy, *quarks cannot experience any gravity*. As clearly stated by Albert Einstein in his writings, gravity can only be defined in spacetime, while quarks can only be defined in the mathematical, internal, complex-valued unitary space with no known connection to our spacetime. In particular, O’Rafearthaigh’s theorem prohibits quarks to be defined via our spacetime symmetries. Consequently, physicists who support the hypothesis that quarks are the physical constituents of protons and neutrons, thus of all nuclei, should see their bodies levitate due to the absence of gravity.

INSUFFICIENCY 3. When, again, interpreted as physical particles in our spacetime, *quarks cannot have any inertia*. In fact, inertia can only be rigorously admitted for the eigenvalues of the second order Casimir invariant of the Poincaré symmetry, while quarks cannot be defined via such a basic spacetime symmetry, as expected to be known by experts to qualify as such. Consequently, “quark masses” are purely mathematical parameters deprived of technical characterization as masses in our spacetime. Hence, “quark masses” are mere *ad hoc* parameters identified by pre-selected fits of data.

INSUFFICIENCY 4. Even assuming that, with unknown scientific manipulations, the above insufficiencies are resolved, it is known by experts that quark theories at the level of first quantization have failed to achieve a representation of *all* characteristics of hadrons, with catastrophic insufficiencies in the representation of spin, magnetic moment, mean lives, charge radii and other basic features of hadrons. Of course Quantum Chromodynamics (QCD) and gauge theories have provided deeper insights, but not a resolution of the controversies due to the inability to reach exact solutions of nonlinear partial differential equations.

INSUFFICIENCY 5. It is also known by experts that the application of quark conjectures to the structure of nuclei has multiplied the controversies, while re-

solving none of them. As an example, the assumption that quarks are the physical constituents of protons and neutrons in nuclei has failed to achieve a representation of the main characteristics of the simplest possible nucleus, the deuteron because:

5.1. Quark conjectures are unable to represent the spin 1 of the deuteron, since they predict spin zero in the ground state of two particles each having spin $1/2$, while the deuteron has spin 1;

5.2. Quark conjectures are unable to represent the anomalous magnetic moment of the deuteron despite all possible relativistic corrections attempted for decades, because the presumed "quark orbits" are too small to fit data following polarizations or deformations;

5.3. Quark conjectures are unable to represent the stability of the neutron when a deuteron constituent;

5.4. Quark conjectures are unable to represent the charge radius of the deuteron, and

5.5. When passing to larger nuclei, such as the zirconium, the catastrophic inconsistencies of quark conjectures can only be defined as being embarrassing.

For additional references, one may consult Ref. [88] on historical reasons preventing quarks to be physical particles in our spacetime; Ref. [106] on a technical treatment of the impossibility for quarks to have gravity or inertia; Ref. [97,107] on a more detailed presentation on the topic of this section; and Wilhelm [103] for an in-depth treatment of the lack of rational priorities in quark theories.

The implications of the above insufficiencies are rather serious. In fact, they imply that *the identification of the hadronic constituents with physical particles truly existing in our spacetime is more open than ever and carries ever increasing societal implications since the assumption that quarks are physical constituents of hadrons prevents due scientific process on alternative models admitting new clean energies so much needed by mankind, as illustrated later on.*

Alternatively, we can say that *the insufficiencies of quark conjectures as physical particles in our spacetime render the current status of hadron physics essentially equivalent to our knowledge of atoms at the beginning of the 20-th century, namely, prior to the discovery of their structure. We did have at that time the Mendeleev-classification of atoms into families, but we had yet to initiate the study of the structure of individual atoms. Similarly, at this writing $SU(3)$ color theories and the standard model have indeed provided the final classification of hadrons into family. However, on serious scientific ground the structure of individual hadrons of a given $SU(3)$ -multiplet must be indicated as being unknown.*

As stressed in Section 6.2.1, *all alternative structure models, including those without neutrino and quark conjectures, must achieve full compatibility with the unitary models of classification, in essentially the same way according to which*

quantum structures of atoms achieved full compatibility with their Mendeleev classification.

On historical grounds, the classification of nuclei, atoms and molecules required *two different models*, one for the classification into families and a separate model for the structure of the individual elements of a given family. Quark theories depart from this historical teaching because of their original conception of attempting to represent with one single theory both, the classification and the structure of hadrons. Admittedly, in recent times quarks are differentiated whether characterizing classification and structure, but the problematic aspect persists because of the belief that one single theory can represent the totality of the phenomenology of particles. Hence, current quark theories are basically flawed in their conception. .

The view advocated by Santilli since 1978 [14] (see paper [88] of 1981 and paper [106] of 2006, all completely ignored by organized financial interests on quark conjectures to this date - November 11, 2007) is that, quite likely, history will repeat itself. The transition from the Mendeleev classification of atoms to the atomic structure required a basically new theory, quantum mechanics, due to the large differences existing in the classification and structure of atoms. Similarly, the transition from the Mendeleev-type classification of hadrons to the structure of individual hadrons will require a broadening of the basic theory, this time a generalization of quantum mechanics and special relativity due to the truly dramatic differences of the dynamics of point-particles moving in vacuum, as in the atomic structure, to the dynamics of extended wavepackets moving within hyperdense media, as in the hadronic structure.

6.2.5 Hadronic Two-Body Bound State

The *hadronic two-body bound state* was proposed and solved in the original proposal [14] (see Ref. [14b] Section 5), then used to illustrate, not only the capabilities of hadronic mechanics, but also the achievement of feature unthinkable with quantum mechanics.

The main result of the study was the achievement of a *quantitative representation of the charge independence of strong interactions*, namely, the feature known since Fermi's times that strong interactions are generally attractive irrespective of the relative signs of the charge. In turn, this is the very feature that justified the use of the name "hadronic mechanics" in the original proposal.

The above important achievement was reached by showing that *the mutual penetration of particles in singlet coupling at mutual distances of the order of the range of strong interactions (1 fm) causes a strongly attractive force independent from the sign of their charges*. There is no word to stress emphatically that this basic feature is impossible for quantum mechanics.

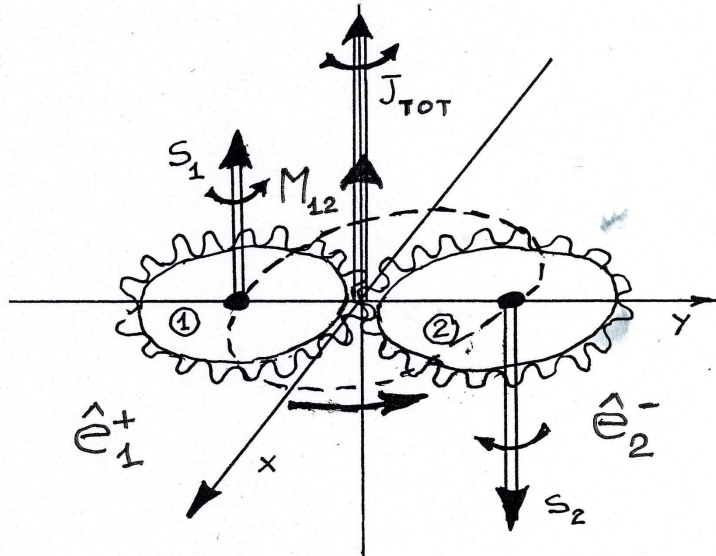

Figure 6.20. A schematic view of the *gear model* for the singlet coupling of two particles at mutual distances of the order of the range of the strong interactions proposed in Ref. [14b], page 852, to illustrate that stable bound states at the mutual distance here considered can only occur for singlet couplings, while triplet couplings cause strong repulsive forces, as it occurs for the coupling of ordinary gears.

This is, by far, one of the most important advances permitted by hadronic mechanics with deep implications for all structural problems, including mesons, baryons, nuclei, molecules, stars, quasars, etc. It is expected as being admitted by the mind most resilient to advances that the achievement of the first quantitative understanding of the mechanism of attraction under strong interactions is the necessary pre-requisite for basically new clean energies and fuels, thus mandating its study.

In this section we review the above features as proposed in Ref. [14b], plus the very few additional details emerged since 1978. The rest of this volume is essentially dedicated to an *application* of the content of this section. It is unfortunate that, despite the above features, proposal [14] remained ignored for decades by organized interests in quantum mechanics and special relativity, despite our bringing it to the attention of "leading" (?) physicists via letters, explanations, petitions and the like. Yet, as stressed several times, their lack of response was appreciated because a gift of scientific priority to our group. Let us begin with the following:

HADRONIC POSTULATE 1: All particles at mutual distances of the order of the strong interactions experience a strongly "attractive" force in "singlet" coupling and a "repulsive" force in "triplet" coupling.

This postulate was introduced and illustrated in proposal [14b] via the following (see Figure 6.22):

GEAR MODEL: Gears can only be coupled in singlet.

In essence, when particle wavepackets penetrate one inside the other, as in Figure 6.2, their intrinsic rotation remains allowed if and only if the coupling is with anti[parallel spin, while in the event of a coupling with parallel spins it is easy to see the emergence of a strongly *repulsive* force, exactly as it occurs for ordinary gears, trivially, because intrinsic rotations should occur for one wavepacket (one gear) moving against the other.

We assume the reader knows that this is a fundamental feature of nature. In fact, *valence electrons correlate/bond in molecular structures only in singlet pairs*, whose lack of quantitative treatment is one of the biggest century old failure of quantum chemistry. We expect the educated reader to know that a similar feature occurs in nuclear structures. It is our task to show in this section that a similar feature occurs also in the hadronic structure. Hence, from now on, unless otherwise stated, all couplings of particles pairs will be in singlet.

INSUFFICIENCY OF THE QUANTUM SCATTERING THEORY: The author has indicated for decades, to no avail, that the quantum scattering theory is fundamentally inapplicable for deep inelastic scatterings, because quantum mechanics can only represent particles as dimensionless points. Consequently, quantum mechanics has no mean to differentiate singlet and triplet couplings. Lacking such a differentiations, all "experimental results" in deep inelastic scatterings based on the conventional "quantum, scattering theory, are certainly suitable to secure large public funds, academic chairs and prizes, but they are mere "experimental beliefs" on strict scientific grounds, and they will remain so until vast theoretical and experimental studies are conducted via a covering scattering theory with a credible differentiation between singlet and triplet couplings.

A further notion needed for the understanding of this section is that of the *trigger*. In essence, experimental evidence studied later on indicates that spinning particles, such as the electrons, do not achieve a state of deep mutual penetration of their wavepackets in singlet coupling, unless there is an external intervention called "trigger." Alternatively, we can say that spinning particles have a *hadronic horizon*, given by a sphere of radius 1 fm separating the validity of quantum mechanics in the outside and that of hadronic mechanics in the inside. The "trigger" is then the external action need to cross the hadronic horizon.

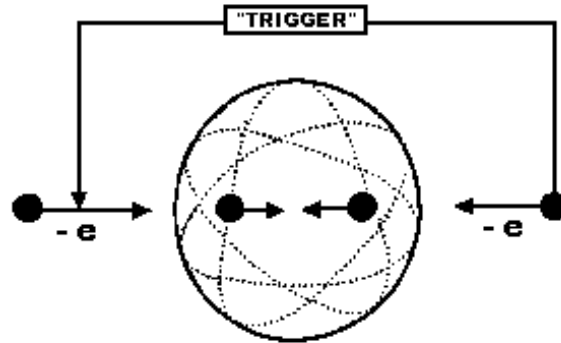

Figure 6.21. A schematic view of the *trigger*, namely, an action generally needed for two particles to cross the *hadronic horizon* and activate strong interactions. This notion will emerge better later on when we study the laboratory synthesis of the neutron from protons and electrons, and related new clean energies. At this moment we assume simple realizations of the "trigger," e.g. those merely caused by sufficient kinetic energy to achieve the deep penetration of the wavepackets needed to activate hadronic mechanics.

In nature, the best known realization of the "trigger" is the pressure in the core of stars "compressing," in Rutherford's words, the electron inside the proton to synthesize the neutron. However, we shall see in Chapter 8 that the Cooper pair in superconductivity is created thanks to a "trigger" caused by cuprates. Similarly, we shall see in Chapter 9 that electron valence bonds are triggered by nuclei.

To put it differently, isolated electrons *repel* each other due to their identical charge, and certainly cannot form any bond. An external intervention is then needed to create electron pairs in valence couplings, Cooper pairs and other structures, namely, to cross the hadronic horizon as a necessary condition to activate the charge independent, strongly attractive forces identified below.

After these background lines, we pass to a review of the two-body hadronic model proposed in Ref. [14b], Section 5. As indicated since the introductory Section 6.2.1, Eq. (6.1.2), the objective is the study of the lifting of a conventional quantum bound state under a nonunitary transform. The lifting of the center-of-mass motion is trivial and is left to the interested reader.

Additionally, the isoeigenvalues of the *isotopic rotational symmetry* for the angular momentum component are conventional [5a,5b] and they are hereon ignored because inessential for the content of this section. Hence, we consider the important part, the nonunitary lifting of a conventional, two-body, Schrödinger's

equation in relative coordinates

$$\left(\frac{p \times p}{m} - \frac{z \times e^2}{r}\right) \times \psi(r) = E_0 \times \psi(r), \quad E_0 \in R, \quad E_0 < 0. \quad (6.2.25a)$$

$$p \times \psi(r) = -i \times \partial_r \psi(r), \quad (6.2.25b)$$

where r is the relative distance, m is the reduced mass and we have assumed $\hbar = 1$.

As familiar to the reader who has studied the preceding parts. the desired lifting is characterized by *the same nonunitary transform applied to the totality of the quantum mechanics formalism, including the totality of their operations*, with no exception to avoid the Theorems of Catastrophic Inconsistencies of Section 6.1.6, and we shall write

$$U \times U^\dagger \neq I, \quad U \times U^\dagger > 0, \quad (6.2.26a)$$

$$I \rightarrow \hat{I} = U \times I \times U^\dagger = 1/\hat{T} > 0, \quad (6.2.26b)$$

$$A \rightarrow \hat{A} = U \times A \times U^\dagger, \quad A = p, H, \dots, \quad (6.2.26c)$$

$$U \times (A \times B) \times U^\dagger = \hat{A} \hat{\times} \hat{B} = \hat{A} \times \hat{T} \times \hat{B}, \quad \hat{\psi} = U \times \psi \times U^\dagger, \quad (6.2.26d)$$

The fundamental invariance (intended as the preservation of the same numerical predictions under the same conditions at different times despite the nonunitary structure) is assured by the Santilli isomathematics based on the reconstruction of the totality of the conventional mathematics of quantum mechanics into a form admitting \hat{I} , rather than I , as the correct left and right generalized unit at all levels.

This requires the reformulation of the *nonunitary* transform (evidently expressed on a conventional Hilbert space \mathcal{H} over the field of complex numbers \mathcal{C}) as the *isounitary transform* on a iso-Hilbert space $\hat{\mathcal{H}}$ over the isofield of isocomplex numbers $\hat{\mathcal{C}}$, i.e.,

$$U = \hat{U} \times \hat{T}^{1/2}, \quad U \times U^\dagger = \hat{U} \hat{\times} \hat{U}^\dagger = \hat{U}^\dagger \times \hat{U} = \hat{I}, \quad (6.2.27)$$

under which we have the basic invariances

$$\hat{I} \rightarrow \hat{I}' = \hat{U} \hat{\times} \hat{I} \hat{\times} \hat{U}^\dagger \equiv \hat{I}, \quad (6.2.28a)$$

$$\hat{A} \hat{\times} \hat{B} \rightarrow \hat{U} \hat{\times} (\hat{A} \hat{\times} \hat{B}) \hat{\times} \hat{U}^\dagger = \hat{A}' \hat{\times} \hat{B}', \quad (6.2.28b)$$

where one should note the preservation of the numerical value of the isounit essential for measurements, from which all other invariances follow.

At this point *readers still intent in using conventional mathematics are discouraged from continuing the glancing of this section*, because it would be like

elaborating "quantum" equations with "isomathematics," resulting in a complete nonscientific nonsense. This implies the reader abandoning the use of sinus, cosinus, exponential, differential and *all* mathematics so familiar for protracted use, and the replacement with isotopic covering forms.

Under the above assumptions, the isounitary lifting of Schrödinger equations yields the Schrödinger-Santilli isoequations

$$\begin{aligned} U \times \left(\frac{p \times p}{m} - \frac{z \times e^2}{r} \right) \times \psi(r) \times U^\dagger &= \\ &= \left(\frac{1}{m} \hat{p} \times \hat{T} \times \hat{p} \times \hat{T} - \frac{z \times e^2}{r} \right) \times \hat{\psi}(r) = \\ &= U \times [E_0 \times \psi(r)] \times U^\dagger = \hat{E} \times \hat{\psi} = E \times \hat{\psi}, \end{aligned} \quad (6.2.29a)$$

$$\begin{aligned} U \times [p \times \psi(r)] \times U^\dagger &= \hat{p} \times \hat{\psi}(r) = \\ &= -U \times [i \times \partial_r \psi(r)] \times U^\dagger = -\hat{i} \times \hat{\partial}_r \hat{\psi} = -i \times \hat{T} \times \partial_r \hat{\psi}(r), \end{aligned} \quad (6.2.29b)$$

where one should note the *lifting of the numerical value of the binding energy* from E_o to E , trivially, due to the lifting of the operator from H to $H \times T$,³¹ with consequential lifting of the wavefunction. One should also note that there is no isotopic element in the r.h.s of the Coulomb term because of the lifting of the fraction for which we can symbolically write

$$U \times [(/) \times \psi] \times U^\dagger = (\hat{/) \times \hat{\psi} = (/) \times U \times \psi \times U^\dagger = (/) \times \hat{\psi}. \quad (6.2.30)$$

Alternatively, the isounitary lifting solely generalizes operators and eigenfunctions and cannot lift scalars.

As it will soon be evident, Eqs. (6.2.29) are insufficient for the hadronic bound state because they miss the "trigger" that, being external, has to be added. The trigger here assumed is of Coulomb nature, it is represented by the addition in Eq. (6.2.29a) of the term $(e^2/r) \times \hat{T}$, and we shall write³²

$$\left(\frac{1}{m} \hat{p} \times \hat{T} \times \hat{p} \times \hat{T} - \frac{z \times e^2}{r} + \frac{e^2}{r} \times \hat{T} \right) \times \hat{\psi}(r) = E \times \hat{\psi}(r). \quad (6.2.31a)$$

$$\hat{p} \times \hat{T} \times \hat{\psi}(r) = -i \times \hat{T} \times \partial_r \hat{\psi}(r), \quad (6.2.31b)$$

To proceed, we now assume the isounit

$$\hat{I} = \text{Diag.}(n_1^2(1), n_2^2(1), n_3^2(1), n_4^2(1)) \times \text{Diag.}(n_1^2(2), n_2^2(2), n_3^2(2), n_4^2(2)) \times$$

³¹Note that \hat{H} and \hat{T} do not generally commute. As a consequence, $\hat{H} \times \hat{T} \times \hat{\psi} \neq \hat{T} \times \hat{H} \times \hat{\psi}$.

³²The sign of the trigger will soon result to be inessential.

$$\times e^{(\psi/\hat{\psi}) \times \int dr^3 \hat{\psi}^\dagger(r)_{1\downarrow} \times \hat{\psi}(r)_{2\uparrow}} \quad (6.2.32)$$

where the two diagonal matrices represent the shapes (assumed to be spheroids) and the densities of the particle considered, while the last term represents the non-Hamiltonian interactions. As now familiar, the above isounit represents:

- 1) The nonlocality of the strong interactions expressed by the volume integral of waveoverlapping, as per historical legacy;
- 2) The nonlinearity of the strong interactions expressed by an explicit dependence of the isounit on the wavefunctions, also as epr historical legacy; and
- 3) The non-Hamiltonian character of the strong interactions, also per open historical legacy, here referred to the inability for their complete representation with a Hamiltonian and the need for a second operator, the isounit.³³

The above isounit is excessively general for the limited scope of this section. We shall then use the approximate expression characterized by:

- 1) The assumption that the particles have a point-like *charge*, such as the electrons, in which case the characteristic quantities can be approximated to 1 and the two diagonal matrices in (6.2.31) be ignored in first approximation;
- 2) The evaluation of the volume integral into a constant; and
- 3) The expansion of the isoexponent terminated to the second term.

The above approximations yield the expressions

$$\hat{I} \approx e^{N \times \psi/\hat{\psi}} \approx 1 + N \times \psi/\hat{\psi}, \quad (6.2.33a)$$

$$\hat{T} \approx e^{-N \times \psi/\hat{\psi}} \approx 1 - N \times \psi/\hat{\psi}, \quad (6.2.33b)$$

$$N = \int dr^3 \hat{\psi}^\dagger(r)_{1\downarrow} \times \hat{\psi}(r)_{2\uparrow}, \quad (6.2.32c)$$

$$|\hat{I}| \gg 1, \quad |\hat{T}| \ll 1, \quad (6.2.33d)$$

$$\text{Lim}_{r \gg 1fm} \hat{I} = 1. \quad (6.2.33e)$$

Note that the explicit form of ψ is of the familiar Coulomb type, thus behaving like

$$\psi \approx P \times \exp(-b \times r), \quad (6.2.34)$$

³³As we shall see in the next chapter, one of the biggest failure of the nuclear physics of the 20-th century has been the inability to understand nuclear forces, despite recent representations with a very large number of terms researchers keep adding to the Hamiltonian in the dream of finding an accurate representation. The origin of the failure is precisely the belief that the strong nuclear forces are entirely representable with a Hamiltonian while the physical reality is dramatically more complex than that. The main point here raised is that, of course, strong interactions have a Hamiltonian component, but they also have a "contact" component dramatically beyond the representational capabilities of a Hamiltonian. Such a "contact" component *cannot* be represented with a potential to prevent major physical distortions equivalent to granting a potential to resistive forces. Hadronic mechanics was built to represent such a contact, non-Hamiltonian component in an axiomatically consistent and invariant way.

with P (approximately) constant and hadronic horizon

$$r_h = \frac{1}{b}, \quad (6.2.35)$$

while $\hat{\psi}$ behaves like (see also below)

$$\hat{\psi} \approx Q \times \left(1 - \frac{e^{-b \times r}}{r}\right), \quad (6.2.36)$$

with Q also (approximately) constant.

By introducing the *Hulthen potential*

$$V_{Hulthen} = W \frac{e^{-b \times r}}{1 - e^{-b \times r}}, \quad (6.2.37)$$

where W is Hulthen's constant, the isotopic element can be written

$$\hat{T} \approx 1 - N \times \psi / \hat{\psi} = 1 - V_0 \frac{e^{-b \times r}}{(1 - e^{-b \times r})/r}, \quad (6.2.38)$$

where we have a new Hulthen constant because it has absorbed the constant N in Eq. (6.2.38) for the Hulthen potential.

Recall that *the Hulthen potential behaves at small distances like the Coulomb potential*,

$$V_{Hulthen} \approx \frac{V_0}{b} \times \frac{1}{r}. \quad (6.2.39)$$

An understanding of the strength of the Hulthen potential is then given by the fact that the quantity b in the denominator is of the order of 10^{-13} cm, thus resulting in a multiplicative factor of the order of 10^{13} .

As a result, *inside the hadronic horizon, the Coulomb potential is absorbed by the Hulthen potential*, and we can write

$$+\frac{e^2}{r} \times \hat{T} - \frac{z \times e^2}{r} \approx +\frac{e^2}{r} \times \left(1 - \frac{V_{Hulthen}}{r}\right) - \frac{z \times e^2}{r} = -V \times \frac{e^{-b \times r}}{1 - e^{-b \times r}}, \quad (6.2.40)$$

therefore resulting in the desired overall attractive force inside the hadronic horizon.

By assuming in first approximation

$$|\hat{T}| \approx \rho < 1, \quad (6.2.41)$$

and by reinstating \hbar for clarity, the radial isoequation can be written

$$\left[\frac{1}{r^2} \left(\frac{d}{dr} r^2 \frac{d}{dr} \right) + \frac{m}{\rho^2 \times \hbar^2} \left(E_{hb} + V \times \frac{e^{-b \times r}}{1 - e^{-b \times r}} \right) \right] \times \hat{\psi}(r) = 0, \quad (6.2.42)$$

where E_{hb} is the hadronic binding energy and, again, we have ignored the Coulomb term because absorbed in the Hulthen potential (see Ref. [14b] for the inclusion of the Coulomb term).

The exact solution and related boundary conditions were first computed in detail in Ref. [14b], Section 5, page 837, and remain fully applicable today. By assuming the change of variable

$$x = 1 - e^{-b \times r} \quad (6.2.43)$$

Eq. (6.2.42) can be written

$$\left[x \times (1 - x) \times \frac{d^2}{dx^2} - (2 \times |A|^{1/2} + 1) \times \frac{d}{dx} + \beta^2 \right] \times S(x) = 0, \quad (6.2.44a)$$

$$A = \frac{m}{\hbar^2 \times \rho^2 \times b^2} \times E_{ib} < 0, \quad \beta^2 = \frac{m \times V_0}{\hbar^2 \times \rho^2 \times b^2}, \quad (6.2.44b)$$

with boundary conditions

$$S(0) = 0, \quad \text{Lim}_{r \rightarrow \infty} e^{-|A|^{1/2} \times b \times r} \times S(r) = 0, \quad (6.2.x45)$$

The solution of Eq. (6.2.44a) is then given by (Ref. [14b], Eq. (5.1.19), page 837)

$$G_n(x) = \sum_{k=1}^{k=n} \binom{n-1}{k-1} \times \binom{n+k+2 \times |A|^{1/2} - 1}{k} \times x^k, \quad (6.2.46)$$

and can be rewritten

$$\hat{\psi}(r) = {}_2F_1(2 \times \gamma + 1 + n, 2 \times \gamma, e^{-b \times r}) \times \frac{1 - e^{-b \times r}}{r} \times e^{-b \times r}, \quad (6.2.47a)$$

where

$$\gamma = \frac{\beta^2 - n^2}{2 \times n}, \quad (6.2.48)$$

with isorenormalized isoeigenfunctions (Ref. [14b] Eq. (5.1.29), page 839)

$$\hat{\psi}(r) = \left[\frac{\Gamma(2 \times |A|^{1/2} + 3)}{\Gamma(3) \times \Gamma(2 \times |A|^{1/2})} \right]^{1/2} \times \frac{1 - e^{-b \times r}}{r} \times e^{-|A|^{1/2} \times b \times r} \quad (6.2.49)$$

The *hadronic binding energy* is then given by (Ref. [14b], Eq. (5.1.20), page 847)

$$E_{hb} = -\frac{\hbar^2 \times \rho^2 \times b^2}{4 \times m} \times \left(\frac{m \times V_0}{\hbar^2 \times \rho^2 \times b^2 \times n} - n \right)^2 =$$

$$= -\frac{V_0}{4 \times \beta^2} \times \left(\frac{\beta^2}{n} - n \right)^2. \quad (6.2.50)$$

The boundary conditions now demand that

$$\beta^2 = \frac{m \times V_0}{\hbar^2 \times \rho^2 \times b^2} > n^2. \quad (6.2.51)$$

The above results recovers the well known property that *the Hulthen potential has a finite spectrum of eigenvalues*. This feature begins to illustrate the hadronic bound state because the corresponding quantum state has an infinite spectrum of energy. However, as we shall see in the next section, *to be fully hadronic, the bound state must suppress the Hulthen spectrum down to only one value, the particle considered*, because, as indicated earlier, excited states would exit the hadronic horizon and be quantum mechanical.

The original derivation [14b] then proceeds to reduce the above solution to a form usable for hadronic structure models. For an isoparticle to be bounded inside the hadronic horizon b^{-1} , its isowavelength must be proportional to the horizon itself, and we shall write

$$\lambda = (k_1 \times b)^{-1} / 2 \times \pi, \quad (6.2.52)$$

where k_1 is a positive quantity that must be constant for a stationary state.

Next, the *hadronic kinetic energy* E_{hk} of one constituent can be written

$$E_{hk} = \frac{\hat{p}^2}{2m} \approx \frac{\hbar^2 \times \rho^2 \times b^2}{2 \times m}, \quad (6.2.53)$$

34

Next, Ref. [14b] introduces the following second constant

$$k_2 = \beta^2 = \frac{m \times V_0}{\hbar^2 \times \rho^2 \times b^2} = 1 + \epsilon, \quad (6.2.54)$$

from which we have the expression

$$V_0 = k_2 \times \frac{\hbar^2 \times \rho^2 \times b^2}{m} = 2 \times k_2 \times E_{hk} \quad (6.2.55)$$

Hence, the *hadronic total energy* of the hadronic bound state is given by (Ref. [14b] Eq. (5.1.28), i.e.,

$$E_{ht} = 2 \times E_{hr} + 2 \times E_{hk} - E_{hb} \approx 2 \times k_1 \times [1 - (k_2 - 1)^2] \times \hbar \times b \times c_o =$$

³⁴Ref. [14b], page 838, stresses the need to use the "physical" momentum $p = m \times v$, and not the "canonical" linear momentum, because, under nonpotential forces, the latter, in general, has no connection to the physical quantity.

$$= 2 \times k_1(1 - \epsilon^2) \times \hbar \times b \times c_o. \quad (6.2.56)$$

where c_o is the speed of light in vacuum, and one should remember that the last approximation holds for hadronic bound states where the rest energy is ignorable with respect to the kinetic energy, as we shall see to be the case for isoelectrons.

At this point Ref. [14b] had reached an expression for the total energy of the two-body hadronic bound state that, however, depends on two unknowns, k_1, k_2 . To achieve a numerical solution, Ref. [14b] introduces, as a second expression, the *meanlife* of the hadron considered, since *we solely consider unstable hadrons*. The expression selected for the meanlife is the familiar one

$$\tau^{-1} = \lambda^2 \times |\hat{\psi}(0)|^2 \times \frac{\alpha^2 \times E_{hk}}{\pi \times \hbar}. \quad (6.2.57)$$

where α is the fine structure constant, and the reader should keep in mind that the meanlife τ^{-1} is isotopic, that is, derived via isotopic methods, like all other measurable quantities.. By using the above expressions, we can write

$$\begin{aligned} & \hat{\psi}(0) \left[\frac{\frac{1}{2} \times (k_2 - 1) \times \Gamma[\frac{1}{2} \times (k_2 - 1) + 2]}{3! \times \Gamma[\frac{1}{2} \times (k_2 - 1)]} \right]^{1/2} \times b = \\ & = \left[\frac{\frac{1}{4} \times (k_2 - 1)^2 \times \Gamma[\frac{1}{2} \times (k_2 - 1) + 1]}{6 \times \Gamma[\frac{1}{2} \times (k_2 - 1)]} \right]^{1/2} \times b = \frac{(k_2 - 1)^{3/2}}{48^{1/2}} \times b. \end{aligned} \quad (6.2.58)$$

The meanlife of the hadronic bound state then becomes

$$\begin{aligned} \tau^{-1} &= \frac{4 \times \pi}{k_1^2 \times b^2} \times \frac{(k_2 - 1)^3}{48} \times \frac{K_1 \times \hbar \times b \times c_o}{(137)^2 \times \hbar} = \\ &= \frac{4 \times \pi}{48 \times (137)^2} \times \frac{(k_2 - 1)^3}{k_1} \times b \times c_o. \end{aligned} \quad (6.2.59)$$

In this way, Ref. [14b], Eqs. (5.1.32), page 840, reached a *system of two equations with two unknown quantities*, k_1, k_2 expressed in terms of the total rest energy E_{tot} , the meanlife τ and the charge radius R_c of the two-body hadronic bound state, that it is reproduced identically below

$$k_1 \times [1 - (k_2 - 1)^2] = \frac{E_{ht}}{2 \times \hbar \times b \times c_o}. \quad (6.2.60a)$$

$$\frac{(k_2 - 1)^3}{k_1} = \frac{48 \times (137)^2}{4 \times \pi \times b \times c_o} \times \tau^{-1} \quad (6.2.60b)$$

The most important results can be summarized as follow:

CHARGE INDEPENDENCE OF STRONG INTERACTIONS. To the best of our knowledge, hadronic mechanics achieves the first and only known quantitative representation of the charge independence of strong interactions. As clear from the preceding analysis, this important result is achieved via the use of a force that is strongly attractive inside the hadronic horizon and such to behave like the Coulomb force, thus absorbing the latter irrespective of whether attractive or repulsive.

Alternatively, the same result can be achieved with an attractive force other than the Hulthén one not necessarily behaving like the Coulomb force inside the hadronic horizon, but sufficiently stronger than the latter as an evident condition to reach charge independence.

To fully understand the mechanism, the reader should keep in mind that the actual representation occurs on iso-Hilbert spaces over isofields, and that the treatment presented in this section has been the *projection* of the isotopic treatment in our Euclidean space for clarity.

MASS-ENERGY ISORENORMALIZATIONS. Ref. [14b] achieved the first and only known renormalization originating from contact, non-Lagrangian / non-Hamiltonian interactions, called *isorenormalizations*, given the following liftings of quantum rest (qr) and quantum kinetic (qk) energies into the corresponding hadronic rest (hr) and hadronic kinetic (hk) energies

$$E_{qr} = m_{qr} \times c_o^2 \rightarrow \hat{E}_{hr} = m_{hr} \times c_o^2 = \frac{m_{qr}}{\rho^2} \times c_o^2, \quad (6.2.61a)$$

$$E_{qk} = \frac{1}{2 \times m_{qr}} \times p^2 \rightarrow \hat{E}_{hk} = \frac{1}{m_{hr}} \times p^2 = \frac{\rho^2}{m_{qr}} \times p^2, \quad (6.2.61b)$$

which are *necessary* to resolve the inconsistency of quantum mechanics under "positive" binding energies (Section 6.2.2), as we shall see in the next sections.

In fact, the resolution permitted by hadronic mechanics is that, when a quantum solution is impossible because the value of the rest energy is such to require inconsistent positive binding energies, the isorenormalized total energy becomes so large to admit a *negative* binding energy, as it is the case for the above model.

Note that *isorenormalizations are fully predicted by Santilli isorelativity*. Those considered herein are characterized by the variation of the speed of light and maximal causal speeds within hyperdense media already established by preceding experimental verifications,

$$c = \frac{c_o}{\rho^2} = \frac{c_o}{n_4} = c_o \times b_4, \quad (6.2.62a)$$

$$V_{ma} = c_o \times \frac{n_3^2}{n_4^2} = c_o \times b_4^2$$

$$\frac{n_4^2}{n_3^2} = \frac{b_3^2}{b_4} = \rho^2, \quad (6.2.62b)$$

namely, ρ^2 is a numerical value of the geometrization of the departure of the interior of hadrons from our spacetime.

The reader with a technical knowledge of Santilli's isorelativity knows that the above isorenormalizations can be best derived from the Poincaré-Santilli isosymmetry, that causes, in general, a mutation of *all* intrinsic physical characteristics of particles.

Hence, the most insidious misrepresentation of the content of this section is the theological belief that, when immersed within the hyperdense medium inside hadrons, an ordinary particle such as the electron is the same as that in vacuum. In reality, the electron is characterized by an irreducible representation of the (spinorial covering of) the Poincaré group, while the isoelectron is characterized by a corresponding irreducible representation of the covering Poincaré-Santilli isogroup, with consequential mutations, in general, of all physical characteristics as a result of the distortions in the electron wavepacket and other features caused by the hyperdense medium.

We can say that electromagnetic interactions can only change the *kinematic* characteristics of particles while leaving their *intrinsic* characteristics (spin, parity, etc.) unchanged. By comparison, strong interactions are predicted to cause mutations of *all* characteristics, whether kinematical or intrinsic. Still alternatively, the belief that the electron has spin 1/2 when in the core of a collapsing star is pure theology proffered for personal gains without scientific credibility.

SPECTRUM SUPPRESSION. A basic assumption of hadronic mechanics is that *the excited hadronic states are quantum mechanical* [14b]. Hence, the hadronic bound state studied in this section is consistent if and only if the finite Hulthen spectrum is reduced to one, and only one energy level, that of the hadron considered. Any excitation brings the isoconstituents outside the hadronic horizon, in which the Hulthen potential is null and the state recovers the quantum form. As we shall see, the above crucial condition is indeed verified for our hadronic structure models with conventional massive particles as physical constituents.

It should be indicated that this is expected as being the case for "simple" unstable hadrons, such as light mesons and the first baryons. The possibility of excited states is not excluded for some of the baryonic resonances. Their study is rather complex since it implies the joint use of quantum and hadronic mechanics and will be left to the interested reader.

On historical notes, the most important study of the hadronic bound state following that of Ref. [14b] was done by A. O. E. Animalu [108] who applied the model for the first and only known representation of the structure of the Cooper pair and developed his isosuperconductivity theory reported in Chapter 8. An

additional study was done by Animalu and Santilli [109] that set the basis for chemical applications studied in Chapter 9. No additional study, conducted via the true use of hadronic mechanics, has occurred during the three decades since the original proposal [14b], to our best knoweldge.

6.2.6 The π^o Meson as a Compressed Positronium

Following the detailed solution of the two-body hadronic bound state outlined in the preceding section, Ref. [14b] presented its consistent application for the *representation of all characteristics of the π^o meson as hadronic bound state of one isoelectron and one isopositron*, or as a "compressed positronium" in Rutherford's language, according to models (6.2.7), (6.2.8), Figure 6.20,

$$\pi^o = (\hat{e}^+, \hat{e}^-)_{hm}. \quad (6.2.63a)$$

$$P = (e^+, e^-)_{qm} \rightarrow \pi^o = (\hat{e}^+, \hat{e}^-)_{hm} = U_{\pi^o} \times (e^+, e^-)_{qm} \times U_{\pi^o}^\dagger, \quad (6.2.63b)$$

$$U_{\pi^o} \times U_{\pi^o}^\dagger = \hat{I}_{\pi^o} \neq I, \quad \hat{I}_{\pi^o} > 0. \quad (6.2.63c)$$

The model permitted the exact and invariant representation of: rest energy E_{π^o} , meanlife τ_{π^o} , charge radius R_{π^o} , charge q_{π^o} , spin J_{π^o} , magnetic moments μ_{π^o} , space and charge parities I^G

$$E_{\pi^o} = 134.97MeV, \quad \tau_{\pi^o} = 0.84 \times 10^{-16}s, \quad R_{\pi^o} = 10^{-13}cm, \quad (6.2.64a)$$

$$q_{\pi^o} = 0, \quad J_{\pi^o} = 0, \quad I^G = 1^-, \quad \mu = 0, \quad (6.2.64b)$$

and the spontaneous decay

$$\pi^o = (\hat{e}^+, \hat{e}^-)_{hm} \rightarrow \gamma + \gamma, \quad (98.7798 \pm 0.032)\%, \quad (6.2.65)$$

representing the evident annihilation of the physical constituents, the decay

$$\pi^o = (\hat{e}^+, \hat{e}^-)_{hm} \rightarrow e^+ + e^-, \quad (7.5 \pm 2.0 \times 10^{-8})\% \quad (6.2.66)$$

representing the hadronic tunneling of the physical constituents, the remaining decays, such as

$$\pi^o = (\hat{e}^+, \hat{e}^-)_{hm} \rightarrow e^+ + e^- + \gamma \quad (1.198 \pm 0.032)\% \quad (6.2.67a)$$

$$\pi^o = (\hat{e}^+, \hat{e}^-)_{hm} \rightarrow (e^+, e^-)_{qm} + \gamma \quad (1.82 \pm 0.29 \times 10^8)\% \quad (6.2.67b)$$

being secondary effects.

The model is merely given by structural isoequation (9.6.42) combined with the meanlife (6.2.57) and charge radius as subsidiary constraints, merely reformulated for the π^o meson,

$$\left[\frac{1}{r^2} \left(\frac{d}{dr} r^2 \frac{d}{dr} \right) + \frac{m}{\rho^2 \times \hbar^2} \left(E_{hb}^{\pi^o} + V \times \frac{e^{-b \times r}}{1 - e^{-b \times r}} \right) \right] \times \hat{\psi}(r) = 0, \quad (6.2.68a)$$

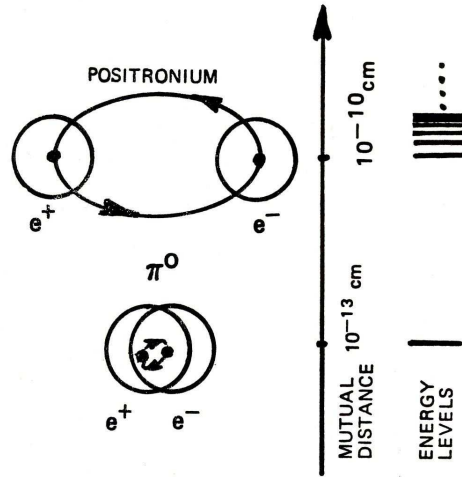

Figure 6.22. Quantum mechanics solely permits the representation of the structure of the π^0 meson as a hypothetical bound state of one hypothetical quark and one hypothetical antiquark that, by conception (but not in quantitative realization) are believed as being permanently confined inside the meson, despite the extreme energies achieved in recent particles accelerators. Despite all these conjectures and shortcomings, the model can only represent *some* and definitely not all the characteristics of the particle. Hadronic mechanics allows a quantitative representation of the π^0 meson as a bound state of one isoelectron and one isopositron at mutual distances of the order of the strong interactions (1 fm), as depicted in Figure 6.20. Alternatively, hadronic mechanics permits the representation of the π^0 meson as a new bound state of the positronium at short distances, or, in Rutherford's words, as a "compressed positronium." Contrary to quark theories, our hadronic model permits the exact and invariant representation of *all* characteristics of the meson, including the spontaneous decays. The model was worked out in all details in Section 5 of memoir [14b] of 1978, and has remained unchanged since that time, although ignored by organized interests in quark theories.

$$\tau^{-1} = \lambda^2 \times |\hat{\psi}(0)|^2 \times \frac{\alpha^2 \times E_{hk}}{\pi \times \hbar}.$$

$$R_{\pi^0} = b^{-1}, \tag{6.2.68c}$$

with ensuing system (6.2.60 in the two unknown quantities k_1 and k_2

$$k_1 \times [1 - (k_2 - 1)^2] = \frac{135}{2 \times \hbar \times 10^{-13} \times c_0}. \tag{6.2.69a}$$

$$\frac{(k_2 - 1)^3}{k_1} = \frac{48 \times (137)^2}{4 \times \pi \times b \times c_0} \times 10^{-16}. \tag{6.2.69b}$$

By using values (6.2.65), the numerical solution is given by Eqs. (5.1.33), Ref. [14b] page 840, i.e.,

$$k_1 = 0.34. \quad (6.2.70a)$$

$$k_2 = 1 + 4.27 \times 10^{-2}. \quad (6.2.70b)$$

The original proposal [14b] continued with the following results. Note that $\beta^2 \approx 1$. Hence, we have

$$\frac{\beta^2}{n} - n \approx 0, \quad \beta^2 = 1 + \epsilon, \quad \epsilon > 0, \quad \epsilon \approx 0, \quad n = 1. \quad (6.2.71)$$

and the hadronic binding energy, Eq. (6.2.49), is ignorable in nonrelativistic approximation,

$$E_{hb} = -\frac{V_0}{4 \times \beta^2} \times \left(\frac{\beta^2}{n} - n \right) \approx 0. \quad (6.2.72)$$

It is easy to see that the hadronic kinetic energy is also ignorable because

$$\begin{aligned} E_{hk,\pi^o} &\approx k_1 \times \hbar \times b \times c_o = \\ &= 0.34 \times (6.5 \times 10^{-22} \text{ MeV s}) \times (10^{-13} \text{ cm}) \times (3 \times 10^{12} \text{ cm/s}) \approx \\ &\approx 6.63 \times 10^{-23} \text{ MeV} \end{aligned} \quad (6.2.73)$$

Consequently, the primary contribution to the total energy of the π^o is that for the hadronic rest energy, as expected from Section 6.2.2 (Ref. [14b], Eq. (5.1.34) page 841),

$$E_{\pi^o} \approx 2 \times E_{hr,\hat{e}} = \frac{m_e \times c_o^2}{\rho^2} = 135 \text{ MeV}. \quad (6.2.74)$$

Recall from Eq. (6.2.33d) and (6.2.41) that

$$\rho^2 = |\hat{T}|^2 \ll 1, \quad (6.2.75)$$

and that the isorenormalization of the quantum rest energy (qr) into the hadronic rest energy (hr) is given by Isoaxiom V of the isospecial relativity, Eq. (6.1.15), i.e.,

$$E_{qr,e} = m_e \times c_o^2 \rightarrow E_{hr,\hat{e}} = m_e \times \frac{c_o^2}{\rho^2} = m_e \times c_o^2 \times \frac{n_3^2}{n_4^2} = m_e \times c_o^2 \times \frac{b_4^2}{b_3^2}. \quad (6.2.76)$$

Hence

$$\rho^2 = |\hat{T}|^2 = \frac{n_4^2}{n_3^2} = \frac{b_3^2}{b_4^2}. \quad (6.2.77)$$

The hadronic total energy can then be written

$$E_{\pi^o} \approx 2 \times m_e \times c_o^2 \times \frac{b_4^2}{b_3^2} = 135 \text{ MeV}. \quad (6.2.78)$$

from which we have the numerical value

$$E_{hr,\hat{e}} = 67.5 MeV \quad (6.2.79a)$$

$$\rho^2 = |\hat{T}|^2 = \frac{b_3^2}{b_4^2} \approx 7.5 \times 10^{-3}. \quad (6.2.79b)$$

All remaining quantities are ignorable in this first nonrelativistic approximation.

By assuming homogeneity and spherical symmetry of the π^o , we have

$$b_1 = b_2 = b_3 - 1, \quad (6.2.81a)$$

$$\rho = n_4 = 1/b_4 = 8.7 \times 10^{-1}, \quad (6.2.81b)$$

and the speed of light within the π^o is given by

$$c = 11.5 \times v_o. \quad (6.2.83)$$

This confirms that the medium inside the π^o meson is of iso-Minkowskian Group III, type 9 (Figure 6.3, thus confirming that phenomenological calculations (6.1.51) are quite approximate, as expected. The following comments are in order:

AXIOMATIC CONSISTENCY. The above model confirms the mechanism provided by hadronic mechanics to avoid the inconsistency of quantum mechanics for the hadronic structure. Recall that a quantum treatment of model (6.2.63) would be catastrophically inconsistent since it would require a "positive" binding energy of about 134 MeV. Hadronic mechanics avoids this inconsistency via the mutation - isorenormalization of the rest energy, namely, of the maximal causal speed inside the π^o such that *the sum of the isorenormalized rest energies of the constituents is bigger than (although close to) the total energy of the π^o . As a result, the hadronic model admits a "negative" binding energy as necessary for consistency.*

Needless to say, the "negative" binding energy is that caused by the Coulomb interactions between electron and positron that has been ignored in first approximation since the latter is considerably smaller than 135 MeV. Its inclusion is left to the interested colleague.

REPRESENTATION OF ALL CHARACTERISTICS OF THE PARTICLE: Remember that quantum mechanics allows the representation of *all* characteristics of the positronium with one single equation, Schrödinger's equation. As a consequence, said equation is indeed of structural character. As stressed in Ref. [14b], Section 5, hadronic mechanics allows the same feature, this time for the π^o meson. In fact, the Schrödinger-Santilli isoequation represents all characteristics (6.2.64) of the π^o , as one can verify.

Primary decay (6.2.65) is directly represented and it is in actuality the best confirmation that the physical constituents are indeed one electron and one positron in a mutated form. Decay (6.2.66) is the hadronic tunnelling of the physical constituents and it is an additional direct confirmation that said constituents are indeed an electron and a positron. The remaining secondary decays require isorelativistic treatment that is not studied at this time. For additional comments, one may inspect Ref. [14b], pages 843, 844, with particular reference to the warning on the inability to compute these secondary decays with the conventional scattering theory due to its unitary character.

By comparison, quark conjectures *do not* represent *all* characteristics (6.2.64), but only *some* of them; they do not admit one single structural equation, but represent different characteristics with generally different procedures; and the spontaneous decays are represented via abuse of academic power, such as the claim that a quark-antiquark system can decay 98 % of the time into two photons, or the claim that the electron and the positron of decay (6.2.66) are "created" at the time of the "disappearance" of the quark-antiquark pair, all this without any explanation and without any quotation of the dissident, refereed publications such as Refs. [88, 101-105].

SUPPRESSION OF THE ATOMIC SPECTRUM. In view of subsidiary condition (6.2.51), characteristic value (6.2.70b) causes the *suppression of the atomic spectrum of energy levels down to only one state, the π^0* . In fact, the value $k_2 > 1$, $k_2 \approx 1$ implies the values $n = 1 < \beta^2 < n = 2$, by therefore suppressing in Eq. (6.2.49) all energy levels from $n = 2$ on, the only allowed level being that for $n = 1$ (see Figure 6.22)

The above atomic spectrum suppression is a most important confirmation of the validity of hadronic mechanics fully identified and emphasized in the original proposal [14b]. In fact, the π^0 meson has no known excited state. Consequently, the admission of even one additional energy levels, besides that for the π^0 , would be inconsistent with experimental evidence.

Besides a confirmation of validity, the suppression of the atomic spectrum has deep implications. *Model (6.2.63a) does indeed admit an infinite number of excited states, but they are those of the positronium.* Alternatively, any excitation of the energy level of the physical constituents of the π^0 causes them to exit the hadronic horizon $R_c = 1$ fm, after which the Hulthen potential is null, and the hadronic model recovers the conventional Schrödinger equation of the positronium uniquely and identically.

Note that the suppression of the atomic spectrum is considered of paramount important to avoid the illusion of studying the structure, while in reality one solely deals with the classification. Different views would require that the Schrödinger equation for the hydrogen atom must include the related Mendeleev family, which is notoriously not the case. The inability to separate the classifica-

tion from the structural problems, while at the foundations of historical studies on nuclei, atoms and molecules, has remained entranced in the minds of researchers in hadron physics due to the political condition of the field.

As we shall soon see, another basic implication of the atomic spectrum suppression is that the transition from the structure of the π^0 to that of the π^\pm requires the *increase* of the number of constituents in order to comply with physical evidence. By comparison, the classification of mesons does not require such an increase, as well known, because we have a classification via mathematical representation of a mathematical symmetry defined on a mathematical complex-valued space without any known connection to our spacetime.

IGNORABLE HADRONIC BINDING ENERGY. Another aspect, that is fundamental for the proper understanding of hadronic mechanics, but also departs dramatically from quantum settings, is that *the hadronic binding energy is so small as being ignorable in first approximation*. It is known in undergraduate studies that contact resistive forces have no potential energy. The main physical origin of structure model (6.2.63) is the *contact, zero-range, interaction* due to the complete immersion of one wavepacket within the other. Hence, any granting of energy to contact interactions responsible for structure (6.2.63) would be outside the boundary of physics.³⁵

³⁵When NASA initiated space missions, it became clear that classical Hamiltonian mechanics permits extreme accuracy for the orbits of satellites *in vacuum*. However, NASA engineers soon discovered that the computation of *the satellite trajectory during re-entry in atmosphere* was afflicted by serious theoretical difficulties, as well as safety concerns due to lack of accurate predictions.

When this insufficiency propagated throughout physics departments in the U.S.A., a physicist from a "leading" college visited NASA to "help" in computing re-entry trajectories. The physicist was allowed to deliver his talk as scheduled, but the affair resulted in great embarrassment because that physicist has insufficiently knowledge of the field, yet was coming from a U. S. institution crucial for NASA obtaining governmental funds.

The embarrassment by NASA engineers was due to the fact that the "physicist" from a "leading" institution had the "illusion" of treating re-entry trajectories with the only theory he knew, conventional Hamiltonian mechanics, that based on the truncated Hamilton equations without external terms (see Volume I). In plain language, the "physicist" was dreaming to represent re-entry trajectories with a Hamiltonian! The embarrassment by the engineers was due to the fact that, at that time, to improve the approximation of the trajectory, they had been forced to use nonpotential forces that had reached the 9-th power of the speed, e.g.,

$$F = -N_0 - N_1 \times v - N_2 \times v^2 - N_3 \times v^3 - N_4 \times v^4 - \\ - N_5 \times v^5 - N_6 \times v^6 - N_7 \times v^7 - N_8 \times v^8 - N_9 \times v^9$$

where the N_s are positive constants. Evidently, they were dealing with a force in three dimensions immensely beyond any dream of representation with a Hamiltonian. With considerable embarrassment, NASA engineers presented great praises to the "learned" academician and gently had him return to his "leading" institution.

The episode circulated in the physics community and partially inspired the author to write two monographs on re-entry trajectories and similar non-Hamiltonian problems, under the title of *Foundations of Theoretical Mechanics*, published by Springer-Verlag, Heidelberg, Germany. Volume I, *The Inverse Problem in Newtonian Mechanics* (1978), directly relevant to the above case, presented a systematic study of the necessary and sufficient conditions for the existence of a potential or a Hamiltonian (the

NEARLY FREE CONSTITUENTS. Quantum bound states, such as nuclei, atoms and molecules, lead to strongly bounded constituents, as well known. By contrast, hadronic bound states lead to *nearly free constituents*, a condition reminiscent of *asymptotic freedom* in quantum electrodynamics (QCD). However, the latter theory is purely Lagrangian, thus granting a potential energy to all possible forces, under which theory, the asymptotic freedom itself becomes as quantitatively unverifiable as the quark conjectures themselves. By contrast, hadronic mechanics grants a potential only to action-at-a-distance interactions, and represents all others outside a Lagrangian or a Hamiltonian. In the latter case, the nearly free condition of the constituents has been rigorously proved in this section for the π^0 by the following evidence: 1) The lack of a potential energy by the dominant structural force, those of contact character; 2) The comparatively ignorable value of potential interactions; and 3) The virtually null value of the binding energy (see Ref. [111] for more details).

ISOSELF DUALITY PREDICTIONS. In Chapter 2, we have stressed that *isoself duality* (invariance under the isodual map as enjoyed by the imaginary unit i) is a new invariance of nature so fundamental that it is verified by the conventional Dirac's equation (thus leading to a basically new interpretation that escaped the physics of the 20-th century), and be assumed at the basis of our cosmology (Section 6.1.15).

Quark supporters have ignored for over a decade this new invariance, and so has been the case by the Particle Data Group who write spontaneous decay (6.2.65) without being aware that it violates this new invariance. It is easy to see

conditions of variational selfadjointness),. Volume I then proved the impossibility for the Hamiltonian to represent nonpotential interactions in the frame of the experimenter from two dimensions on. Volume II, entitled *Birkhoffian Generalization of Hamiltonian Mechanics* (1981), to provide NASA engineers a universal variational principle (evidently necessary for optimization) applicable to all possible, sufficiently smooth re-entry trajectories with unrestricted, variationally nonselfadjoint forces much more complex than the one above.

Unfortunately, to the author's best knowledge (evidence to the contrary would be greatly appreciated for due corrections) NASA engineers were never allowed (or interested) to use the two volumes published by Springer-Verlag, because they were constrained for political reasons to continue their contacts with "leading" physicists at "leading" institutions as a condition for funding.

In turn, the absence of such a of the intended primary use of the two Springer-Verlag monographs provided additional motivation for the author being dubbed "the most plagiarized physicists of the 20-th century," because numerous other researchers subsequently published various papers in "leading" journals without any reference to the author's two volumes in the field, publication occurred with the generally studious intent by the editors of avoiding the consultation of the author as a referee.

As a last act, the author filed in 1994 at the Massachusetts Institute of technology a request of investigations by its ethics committee to receive prophetic phone calls that the author was wasting his time, as it did turn out indeed to be the case, since academic behavior has no control whatsoever by society. As a result of all this, the huge efforts in writing the two volumes with Springer-Verlag (each volume written and rewritten several times to reach referee's acceptance, one full year being spent solely in historical search in various libraries) went into oblivion.

that *the proposed structure model of the π^o is isoselfdual*, being constituted by a particle-antiparticle system

$$\pi^o = (\hat{e}^+, \hat{e}^-)_{hm} \equiv [(\hat{e}^+, \hat{e}^-)_{hm}]^d. \quad (6.2.84)$$

Note that the same invariance is verified by quark-antiquark systems. By contrast, the r.h.s. of decay (6.2.65) is not isoselfdual,

$$\gamma + \gamma \rightarrow (\gamma + \gamma)^d \neq \gamma + \gamma. \quad (6.2.85)$$

A serious knowledge of hadronic mechanics requires the awareness of the complete democracy requested between the treatments of matter and antimatter. In turn, this leads to the prediction that *one of the two photons of decay (6.2.65) is the isodual photon γ^d* (Chapter 2), that is physically distinct from the conventional; photon. Contrary to what released in the Particle Data, the correct form of writing decay (6.2.65) is that verifying isoselfdual invariance

$$\pi^o = (\hat{e}^+, \hat{e}^-)_{hm} \equiv [(\hat{e}^+, \hat{e}^-)_{hm}]^d \rightarrow \gamma + \gamma^d \equiv \gamma + \gamma^d. \quad (6.2.86)$$

By recalling the need for mankind to initiate quantitative studies as to whether a far away galaxy or quasar is made up of matter or of antimatter (chapters 1 and 2), it is hoped that researchers in particle physics will eventually acknowledge basically new invariances, such as isoselfduality, particularly when they have been available for over a decade.

What is at stake, particularly for large laboratories, such as CERN, FER-MILAB, DESY, RUTHERFORD, IJNR, etc. is to avoid the possible waste of truly large public sums in the laboratory fabrication of anti-hydrogen atoms for the purpose of studying their light, because the light emitted by antimatter is available in the elementary decay of the most elementary meson, the π^o .

Note that we have ignored the neutrino decays, such as

$$\pi^o = (\hat{e}^+, \hat{e}^-)_{hm} \rightarrow \nu + \bar{\nu} \quad (8.3 \times 10^{-7}\% \quad 90\%CL), \quad (6.2.87)$$

because purely theoretical and without any direct *experimental* evidence, since neutrinos and antineutrinos cannot be directly detected like the physical particles in the preceding decay. Neutrinos are conjectured based on the production of particles. However, the latter production admits alternative interpretation without the conjecture of the neutrinos and antineutrinos as physical particles. hence, to regain credibility, and prevent shadows of affiliations of the financial interests around the neutrino conjectures, *the Particle Data Group should restrict the data to actual physical particles directly detected in our laboratory, and remove any mention of neutrinos (or quarks) in their data, some of which listed with 90 % Confidence Level!*

It is an instructive exercise for the reader interested in learning hadronic mechanics to prove that the above structure model of the π^0 provides a realization of the *isobox* of Figure 3.7, namely, the structure presented is a mere description from an *outside observer* with our units of space and time because, for an *internal observer* with the internal units of space and time, the same structure may be dramatically different.

To set a distance from political claims, the author wants to stress that the main scope of the research herein presented is to *prove the consistency of ordinary massive physical particles as physical constituents of the π^0* without any claim of uniqueness of the model. In fact, numerous other possibilities exist along the same mechanism of regaining a positive binding energy under suitable isorenormalizations via forces different than the Hulthen force. Their study is left to interested researchers.

On historical comments, the only difference of the above presentation and the original one is the information gained during the three decades that passed in regard to the fact that the maximal causal speed within hadronic matter is given by $V_{max} = c_o \times (b_4/b_3)$ and not by $c = c_o \times b_4$.

6.2.7 Nonrelativistic Structure Model of the Neutron as a Hadronic Bound State of a Proton and an Electron

6.2.7.A Foreword on the Need for New Clean Energies

The neutron is one of the biggest reservoirs of clean energy available to mankind because it is naturally unstable and decays into a highly energetic electron that can be trapped with a thin metal shield, plus the hypothetical neutrino that, in the event it exists, it is innocuous. As clearly stated in the original proposal [14], hadronic mechanics was conceived and constructed for the specific purpose of providing axiomatically consistent methods for quantitative studies of the possibility of tapping the energy contained in the neutron.

Recall that *all* energies available to mankind to date, such as nuclear, atomic and molecular energies, are crucially dependent on the possibility of releasing free nuclear, atomic or molecular constituents. Hence, this historical teaching mandated the construction of a new structure model of the neutron with conventional massive physical constituents that, by central assumption, can be produced free with one mechanism or another as a condition to release the 0.78 MeV contained in the neutron structure.

In this section, we review the author's efforts [95] to achieve a nonrelativistic structure model of the neutron with physical constituents that can be produced free. The relativistic version of the model [96] will be studied in the next section. Considerable additional studies are needed prior to addressing in this volume the possible industrial utilization of the energy inside the neutron, because we are

dealing with a new class of energies, called by the author *hadronic energies*, [112] (see also the review monograph [99]) in order to distinguish them from nuclear, atomic and molecular energies, since hadronic energies originate from mechanics in the structure of individual hadrons, rather than in their collection as it is the case for nuclear energies. The need for additional studies is the reason for presenting energy related aspects in a later chapter.

The possibility of industrial applications of the structure model of this section should be compared with the impossibility of any practical application by the conjecture that the hypothetical, directly undetectable quarks are the actual constituents of the neutron. The belief that quarks are permanently confined inside the neutron, then prevents any possibility whatsoever, not even remote, of practical applications.

By no means the author suggests the termination of studies on quark conjectures and, by no means, the author claims to have resolved the historical problem of the neutron structure. However, the author insists in the ethical duty by the physics community to study alternative structure models of the neutron with actual physical constituents that can be produced free, due to the need for new clean energies to contain increasingly catastrophic climactic changes.

For this reason, the author has denounced (with real names of individuals and institutions) political obstructions against the construction of hadronic mechanics in book [89] and in the 1132 pages of documentation [90]; the author felt an ethical duty to denounce the same obstructions in the footnotes of these two volumes; and the author intends to denounce publicly any additional asocial and ascientific obstruction ventured against the efforts herein reviewed for sinister personal gains without *technical* objections published in *refereed* journals rather than verbose posturing in equivocal academic corridors.³⁶

6.2.7.B Hadronic Realization of Rutherford's Conception

An exact and invariant, nonrelativistic representation of *all* characteristics of the neutron as a hadronic bound state of a proton and an electron in a mutated isotopic form, was first achieved by Santilli in Ref. [95] of 1990,

$$n = (\hat{p}^+, \hat{e}^-)_{hm}. \quad (6.2.88)$$

Equivalently, Ref. [95] achieved a representation of the neutron as a "compressed hydrogen atom" along Rutherford's historical conception [91]. Since the physical conditions of an electron compressed within the hyperdense medium inside a

³⁶Serious scientists interested in contributing to the open problem of the neutron structure can be assured of appreciation, irrespective of whether their technical contributions are critical or supportive. Pseudo-scientists with a priory sinister aims, a rather frequent occurrence nowadays, are suggested to read the Legal Notice at the beginning of this volume prior to implementing their schemes.

proton are dramatically beyond a credible quantum mechanical representation, the model was achieved via a nonunitary transforms of the corresponding model for the hydrogen atom ,

$$H = (p^+, e^-)_{qm} \rightarrow n = (\hat{p}^+, \hat{e}^-)_{hm} = U_n \times (p^+, e^-)_{qm} \times U_n^\dagger, \quad (6.2.89a)$$

$$U_n \times U_n^\dagger = \hat{I}_n \neq I, \quad \hat{I} > 0. \quad (6.2.89b)$$

Paper [95] did present the new structure model without any need for quark conjectures, but said paper did not address neutrino issues. The latter were addressed only recently [9797] with the outcome that *the use of hadronic mechanics does not require any neutrino conjecture for the synthesis of the neutron*, as shown below.

The model permitted the exact and invariant representation of: rest energy E_n , meanlife τ_n , charge radius R_n , charge q_n , spin J_n , magnetic moments μ_n , space and charge parities J_n^G

$$E_n = 939.56 MeV, \quad \tau_n = 885 s, \quad R_c = 10^{-13} cm, \quad q_n = 0, \quad (6.2.90a)$$

$$J_n = \frac{1}{2}, \quad \mu_n = -1.913 \mu_N, \quad I_n^p = \frac{1}{2}^+. \quad (6.2.90b)$$

The spontaneous decay will b studied in a subsequent section since it raises fundamental openings for possible new longitudinal forms of communication.

The model solved in Ref. [95] is the particular case in which the proton has no mutation, and only the electron is mutated,

$$n = (p^+, \hat{e}^-)_{hm} \quad (6.2.91)$$

This approximation is warranted by the fact that the proton is about 2,000 times heavier than the electron, as a result of which the isorenormalizations of the proton are very small compared to those of the electron. In any case, the study of the full model (6.2.88) requires the isorelativistic treatment not considered in this section.

6.2.7.C Representation of the Neutron Rest Energy, Meanlife and Charge Radius.

As it was the case for the π^0 , the representation of all data (6.2.90a) is provided by structural isoequation (9.6.42) combined with the meanlife and charge radius as subsidiary constraints, although reformulated for the neutron [95]

$$\left[\frac{1}{r^2} \left(\frac{d}{dr} r^2 \frac{d}{dr} \right) + \frac{m}{\rho^2 \times \hbar^2} \left(E_{hb} + V \times \frac{e^{-b \times r}}{1 - e^{-b \times r}} \right) \right] \times \hat{\psi}(r) = 0, \quad (6.2.92a)$$

$$\tau^{-1} = \lambda^2 \times |\hat{\psi}(0)|^2 \times \frac{\alpha^2 \times E_{hk}}{\pi \times \hbar}. \quad (6.2.92b)$$

$$R_n = b^{-1}, \quad (6.2.92c)$$

with ensuing system (6.2.60) in the two unknown quantities k_1 and k_2

$$k_1 \times [1 - (k_2 - 1)^2] = \frac{939}{2 \times \hbar \times 10^{-13} \times c_o}. \quad (6.2.93a)$$

$$\frac{(k_2 - 1)^3}{k_1} = \frac{48 \times (137)^2}{4 \times \pi \times b \times c_o} \times 10^{-3}. \quad (6.2.93b)$$

The numerical solution is given by (Ref. [95], Eq. (2.20), page 520)

$$k_1 = 2.6. \quad (6.2.94a)$$

$$k_2 = 1 + 0.81 \times 10^{-8}. \quad (6.2.94b)$$

From the above values, we have the following features: 1) The quantity k_2 is very close to (but bigger than) 1,

$$k_2 = \beta^2 > 1, \quad k_2 \approx 1; \quad (6.2.95)$$

2) The only admitted energy level is $n = 1$; 3) The hadronic binding energy is ignorable in first approximation,

$$E_{hb} = -\frac{V_0}{4 \times \beta^2} \times \left(\frac{\beta^2}{n} - n \right)^2 \approx 0; \quad (6.2.96)$$

4) The hadronic kinetic energy is equally ignorable as in Eq. (6.2.73); and 5) The total hadronic energy of the neutron is primarily characterized by the rest energy of the proton and the isorenormalized rest energy of the isoelectron,

$$E_n \approx E_p + E_{hr,\hat{e}} = E_p + \frac{m_e \times c_o^2}{\rho^2} = 938.272 + \frac{0.511}{\rho^2} = 939.965 \text{ MeV}. \quad (6.2.97)$$

Hence, the isorenormalization provides the missing energy is characterized by

$$m_{\hat{e}} = \frac{0.511}{\rho^2} \text{ MeV} = 1.294 \text{ MeV}, \quad (6.2.98)$$

Since the proton is not mutated in this first approximation as per assumption (6.2.91), we have

$$b_1 = b_2 = b_3 = 1, \quad (6.2.99a)$$

$$\rho^2 = n_4^2 = b_4^{-2} = \frac{0.511}{1.293} = 0.395 \quad (6.2.99b)$$

$$\rho = n_4 = b^{-1} = 0.628 \quad (6.2.99c)$$

$$b_4 = n_4^{-1} = 1.592. \quad (6.2.99d)$$

Astonishingly, the above value for the characterization of the density of the neutron essentially coincides with the experimental value of the density of the fireball of the Bose-Einstein correlation, Eq. (6.1.112).³⁷

³⁷The reader should be aware that, due to an unfortunate clerical mistake, the published version of paper [95] is that of uncorrected galleys, rather than the final version approved by the author. This is

6.2.7.D Representation of the Neutron Spin

The representation of the spin of the neutron for structure (6.2.91) was also achieved for the first time by Santilli in Ref. [95]. Conceptually, the representation is elementary. Model (6.2.91) is possible if and only if (Figure 6.23):

A) The proton and the electron are coupled in singlet, since in triplet they would experience a strong repulsive force;

B) Following the "compression" inside the proton, the electron must acquire an orbital angular momentum equal to the spin of the proton, otherwise the electron has to orbit within and against the hyperdense medium inside the proton, which conditions are impossible for any stable bound state;

C) Consequently, the total angular momentum of the isoelectron is identically null.

Hence, *the spin of the neutron coincides with that of the proton.*

The mathematical representation of the above structure is not trivial and delayed for years the new structure model of the neutron, since it required the previous lifting of the quantum mechanical spin that, in turn, required the prior lifting of Lie's theory and its underlying mathematics.

The isotopies of angular momentum were studied in Ref. [5a] of 1985,³⁸ while the isotopies of spin were first studied in Ref. [5b] of 1989. The background theory was in this way sufficiently known to allow the writing of paper [95] of 1990.³⁹ Following these initial studies, a number of additional papers were devoted to the isotopies of the $SU(2)$ symmetry, such as Ref. [5c] of 1993 published by the *JINR Rapid Communications*. The most comprehensive study in the field is that of paper [5d] published in 1998 by *Acta Publicanbdae Mathematicae* whose impeccable editorial review is here reported with appreciation.

Evidently, we cannot repeat here the vast literature in the isotopies of Lie's theory and are forced to outline its application to the specific problem of the neutron spin. Nevertheless, the reader should be warned that a knowledge of the Lie-Santilli isothory is essential to prevent the illusion of having discovered "inconsistencies" (a not unfrequent occurrence), while in reality we have illiteracy of the new field. Very insidious is the rather natural expectation that the familiar notions of quantum mechanical orbital and intrinsic angular momenta for isolated particles moving in vacuum, equally apply for the same particle when immerses within the hyperdense media inside hadrons, stars or quasars.

shown by a number of evident misprints clearly incompatible with the text. For instance, Eq. (2.45) gives the value $b_4 = 16.5$ basically, while the value for the correct rest energy of the neutron is $b_4 = 1.65$; similarly, there are evident misprints in Eqs. (2.24), (2.32) and others the reader in good faith can easily correct in any case.

³⁸The publication of paper [5a] was delayed for years due to rejections by numerous journals so ascientific and political, the author felt obliged to report in the opening pages of the paper.

³⁹The systematic rejections of paper [95] from all western journals without any visible scientific content have been denounced in the footnotes of Section 6.2.1.

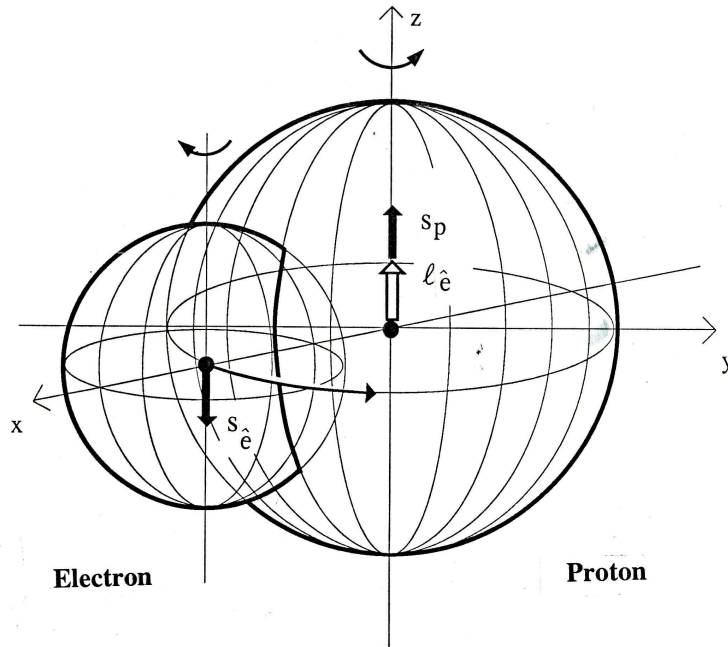

Figure 6.23. A reproduction of Figure 1, page 525, Ref. [98], providing a conceptual view of the orientations of spins and angular momenta needed to achieve a stable structure of the neutron as a hadronic bound state of a proton and an electron.

As an illustration, the third component of the spin of the electron conventionally has the value $\pm 1/2$. However, when the electron is immersed inside the proton, only one value is admitted, that for singlet coupling with the proton, while the other value characterizes strongly repulsive forces. Similarly, the idea that an electron in the core of a collapsing star still has spin $1/2$, is purely political, without any known or otherwise credible scientific support.

In view of the advances occurred since 1990, the mathematical representation of the spin of the neutron is today trivial. Recall that the proton is not mutated because 2000 times heavier than the electron, and that the coupling must be in singlet for stability. This implies that, for the case of the neutron structure, *the spin of the electron is not mutated*. The needed mutation of the quantum into the *hadronic angular momentum* (defined as the angular momentum of a particle immersed within a hadronic medium) is trivially given by the nonunitary-isounitary transforms

$$U \times U^\dagger = \hat{I} = \frac{1}{2}, \quad \hat{T} = 2, \quad (6.2.100a)$$

$$\begin{aligned} L_3 \times Y_{\ell,m}(\theta, \phi) &= 1 \times Y_{\ell,m}(\theta, \phi) \rightarrow U \times [L_3 \times Y_{\ell,m}(\theta, \phi)] \times U^\dagger = \\ &= \hat{L}_3 \times \hat{T} \times \hat{Y}_{\hat{\ell}\hat{m}}(\hat{\theta}, \hat{\phi}) = \frac{1}{2} \times \hat{Y}_{\hat{\ell}\hat{m}}(\hat{\theta}, \hat{\phi}) \end{aligned} \quad (6.2.100b)$$

The mutation is supported by the isotopic invariance of the Hilbert space, Eq. (6.1.28) that, in this case, reads

$$\begin{aligned} \langle \ell, m | \times L_3 \times | \ell, m \rangle \times 1 &\equiv U \times [\langle \ell, m | \times L_3 \times | \ell, m \rangle \times 1] \times U^\dagger = \\ &= \langle \hat{\ell}, \hat{m} | \times 2 \times \hat{L}_3 \times 2 \times | \hat{\ell}, \hat{m} \rangle \times \frac{1}{2}, \end{aligned} \quad (6.2.101)$$

namely, *the mutation of the angular momentum from the quantum value 1 to the hadronic value $\frac{1}{2}$ is a purely internal event not detectable from the outside.*

It is instructive to review the original representation of the spin of the neutron of 1990. For this purpose, Santilli [95] used *irregular isorepresentations* of Lie-Santilli isoalgebras, namely, isorepresentations characterized by nonunitary-isounitary transforms for the generators *different* than those for the product. This difference is rather natural for the structure of the neutron, since the basic nonunitary transform for the rest energy has already been selected, Eq. (6.2.32), hence requiring different nonunitary - isounitary liftings for the angular momentum and for the spin.

For the representation of the hadronic angular momentum, Santilli [95] selected the following irregular isorepresentation of $\hat{S}O(3)$ based on the isodifferential calculus and isolinear momentum (6.2.29b)

$$\hat{I} = U \times I \times U^\dagger = 1/\hat{T} \neq 1, \quad (6.2.102a)$$

$$\hat{L}_k = U \times L_k \times U^\dagger = \epsilon_{kij} \hat{r}_i \hat{\times} \hat{p}_j, \quad (6.2.102b)$$

$$[\hat{r}_i, \hat{r}_j] = [\hat{p}_i, \hat{p}_j] = 0, \quad [\hat{r}_i, \hat{p}_j] = \hat{\delta}_{ij} = \hat{I} \times \delta_{ij} = \rho \times \delta_{ij}, \quad (6.2.102c)$$

$$\begin{aligned} &[\hat{L}_i, \hat{L}_j] \hat{\times} \hat{Y}_{\hat{\ell}\hat{m}}(\hat{\theta}, \hat{\phi}) = \\ &= (\hat{L}_i \hat{\times} \hat{L}_j - \hat{L}_j \hat{\times} \hat{L}_i) \hat{\times} \hat{Y}_{\hat{\ell}\hat{m}}(\hat{\theta}, \hat{\phi}) = \hat{i} \hat{\times} \epsilon_{ijk} \hat{L}_k \hat{\times} \hat{Y}_{\hat{\ell}\hat{m}}(\hat{\theta}, \hat{\phi}) \end{aligned} \quad (6.2.102d)$$

$$\hat{L}^2 \hat{\times} \hat{Y}_{\hat{\ell}\hat{m}}(\hat{\theta}, \hat{\phi}) = \sum_{k=1}^{k=3} \hat{L}_k \times \hat{T} \times L_k \times \hat{T} \times \hat{Y}_{\hat{\ell}\hat{m}}(\hat{\theta}, \hat{\phi}) = \rho^2 \times \hat{\ell} \times (\hat{\ell} + 1) \times \hat{Y}_{\hat{\ell}\hat{m}}(\hat{\theta}, \hat{\phi}), \quad (6.2.102e)$$

$$\hat{L}_3 \hat{\times} \hat{Y}_{\hat{\ell}\hat{m}}(\hat{\theta}, \hat{\phi}) = \rho \times \hat{m} \times \hat{Y}_{\hat{\ell}\hat{m}}(\hat{\theta}, \hat{\phi}), \quad (6.2.102f)$$

$$\hat{\ell} = 1, 2, 3, \dots, \quad \hat{m} = \hat{\ell}, \hat{\ell} - 1, \dots, -\hat{\ell}. \quad (6.2.102g)$$

As one can see, the isotopies lift the integer value of the angular momentum, $\hat{\ell} = 1, 2, 3, \dots$, into the value $\rho \times \hat{\ell}$, where, again, $\hat{\ell} = 1, 2, 3, \dots$, the value $\hat{\ell} = 0$ being excluded by boundary conditions, ρ being a variable depending on the local conditions.

For the study of the *hadronic spin*, (the spin of a particle when immersed within a hyperdense hadronic medium), Santilli [95], page 523, selected the following two-dimensional irregular isorepresentation of $\hat{S}U(2)$

$$\hat{I} = \begin{pmatrix} g_{11} & 0 \\ 0 & g_{22} \end{pmatrix}, \quad \hat{T} = \begin{pmatrix} g_{11}^{-1} & 0 \\ 0 & g_{22}^{-1} \end{pmatrix}, \quad (6.2.103a)$$

$$\hat{J}_1 = \frac{1}{2} \times \begin{pmatrix} 0 & g_{11}^{-1/2} \\ g_{22}^{-1/2} & 0 \end{pmatrix}, \quad \hat{J}_2 = \frac{1}{2} \times \begin{pmatrix} 0 & -i \times g_{11}^{-1/2} \\ i \times g_{22}^{-1/2} & 0 \end{pmatrix}, \quad (6.2.103b)$$

$$\hat{J}_3 = \frac{1}{2} \times \frac{\Delta^{1/2}}{2} \times \begin{pmatrix} g_{11}^{-1} & 0 \\ 0 & -g_{22}^{-1} \end{pmatrix}, \quad \Delta = \text{Det } \hat{I} = g_{11} \times g_{22}, \quad (6.2.103c)$$

$$[\hat{J}_1, \hat{J}_2] = i \times J_3, \quad [\hat{J}_2, \hat{J}_3] = i \times \Delta^{1/2} \times \hat{J}_1, \quad [\hat{J}_3, \hat{J}_2] = 1 \times \Delta^{1/2} \times \hat{J}_2, \quad (6.2.103d)$$

$$\hat{J}^2 \hat{\times} |\hat{j}, \hat{s}\rangle = \sum_{k=1}^3 \hat{J}_k \times \hat{T} \times \hat{J}_k \times \hat{T} \times |\hat{j}, \hat{s}\rangle = \frac{\Delta^2}{3} \times |\hat{j}, \hat{s}\rangle, \quad (6.2.103e)$$

$$\hat{J}_3 \hat{\times} |\hat{j}, \hat{s}\rangle = \hat{J}_3 \times \hat{T} \times |\hat{j}, \hat{s}\rangle = \pm \frac{\Delta}{2} \times |\hat{j}, \hat{s}\rangle, \quad (6.2.103f)$$

Santilli [95] then computed the total angular momentum of the neutron as epr model (6.2.91)

$$J_n = J_p + \hat{L}_{\hat{e}}^{orbital} + \hat{J}_{\hat{e}}^{intrinsic} = \frac{1}{2} + \rho - \frac{\Delta}{2} = \frac{1}{2}, \quad (6.2.104)$$

resulting in the values anticipated above,

$$\rho = \frac{1}{2}, \quad \Delta = 1. \quad (6.2.105)$$

namely, the s[pin of the isoelectron is not mutated and the angular momentum is mutated in such a way that the isoelectron is merely carried out by the proton spin.

6.2.7.E Representatio of the Neutron Anomalous Magnetic Moment

The representation of the anomalous magnetic moment of the neutron also resulted in being elementary [95], *provided* that quantum views are replaced with covering vistas when dealing with dynamics within hyperdense media. The main result of paper [95] in this respect is that *a quantum representation of the anomalous magnetic moment of the neutron is impossible because quantum mechanics does not admit an orbital motion of the electron inside the proton*. By contrast,

when the hadronic orbital motion is admitted, the magnetic moment of the neutron is generated by the following *three* contributions, Ref. [*loc. cit.*], Eq. (2.40, page 526,

$$\mu_n = \mu_p - \mu_{\hat{e}}^{orbital} + \mu_{\hat{e}}^{intrinsic} \quad (6.2.106)$$

Consequently,

$$\begin{aligned} \mu_n &= -1.9 \times \frac{e}{2 \times m_p \times c_o} = \\ &= 2.7 \times \frac{e}{2 \times m_p \times c_o} - 4.6 \times \frac{e}{2 \times m_p \times c_o}, \end{aligned} \quad (6.2.107)(6.2.107)$$

from which we derived the desired values

$$\mu_{\hat{e}}^{tot} = -4.6 \times \frac{e}{2 \times m_p \times c_o} = 2.5 \times 10^{-3} \times \mu_e, \quad (6.2.106b)$$

$$\mu_{\hat{e}}^{orbital} = (1 + 2.5 \times 10^{-3}) \times \mu_e, \quad (6.2.108)$$

where e represents the absolute value and we used: the orientation of the hadronic angular momentum and spin (Figure 6.23); the different signs of the changes of the proton to the electron; and the rescaling of Bohr's unit for the electron magnetic moment from its value in term of m_e to that in terms of m_p as needed for the neutron magnetic moment.

The plausibility of values (6.2.106c) is established by the fact that *the small value of the total magnetic moment of the isoelectron is fully compatible with the null value of its total angular momentum.*

6.2.7.F Concluding Remarks

REPRESENTATION OF ALL CHARACTERISTICS OF THE NEUTRON

It should be stressed that Ref. [95] did achieve a representation of *all* characteristics of the neutron, including rest energy, meanlife, charge radius, spin, anomalous magnetic moment, anomalous electric moment (see [95] for brevity), charge, and parities, plus a direct representation of the spontaneous decay of the neutron given by the hadronic tunneling of its physical constituents, without any theological assumption that the proton and the electron "disappear" at the time of the synthesis to protect vested interests on preferred conjectures.

It should also be stressed that the representation is invariant, due to the isounitary character of the model, namely, the numerical values remain the same under the same basic assumptions at different times. Note that the latter fundamental condition for consistency is not shared by papers using "deformations" of quantum mechanics due to their activation of the Theorems of Catastrophic Inconsistency studied earlier.

These volumes are dedicated to hadronic mechanics and not to other theories. Hence, we solely study models constructed via the full and correct use of the basic

laws of hadronic mechanics, and refer to epistemological studies all other papers, particularly when catastrophically inconsistent. The indication by colleagues of directly relevant papers in the structure of the neutron as per model (6.2.91) verifying the above crucial condition of invariance, would be greatly appreciated for due corrections.

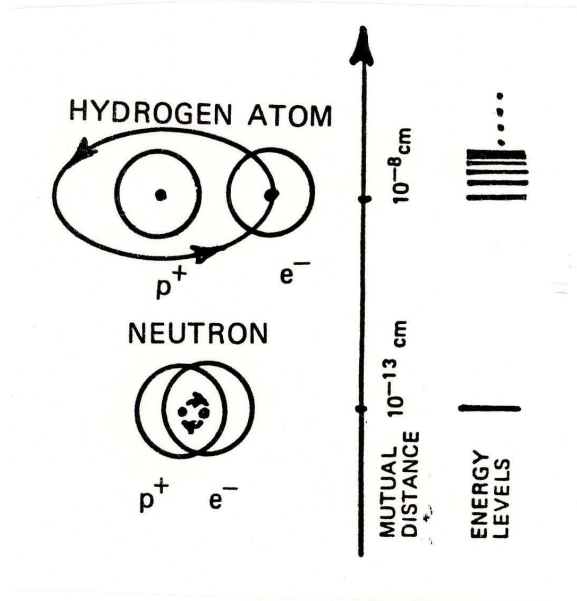

Figure 6.24. An illustration of the main objective of model (6.2.91), the representation of the neutron as a new bound state of the hydrogen at distances of one fm, along Rutherford's historical conception [91]. This conception requires that the neutron has no excited hadronic states, thus requiring the suppression of the atomic spectrum, a condition that is fully verified by hadronic mechanics. In fact, any excitation causes the neutron constituents to pass the hadronic horizon, thus recovering the conventional quantum states of the hydrogen. As we shall see, this feature has potentially fundamental relevance for new clean energies since the neutron is one of the biggest reservoirs of clean energy available to mankind.

COMPATIBILITY WITH OTHER EXPERIMENTAL DATA

As reported in Ref. [99], page 118, Santilli was astonished by value (6.2.99d) because *the numerical value of the characteristic quantity $b_4 = 1.592$ derived from the mere assumption that the neutron is a bound state of a proton and an electron, coincides, within the approximations herein assumed, with the numerical value of $b_4 = 1.653$ obtained from fit (6.1.112) of the experimental data of the Bose-Einstein correlation.* Since the density of the fireball of the Bose-Einstein

correlation is of the same order as the density of the proton, this astonishing compatiobility provides a direct experimental verification of:

- 1) The geometrization of the density of hadronic media via characteristic quantity $b_4 = 1/n_4$ of the Minkowski-Santilli isogeometry;
- 2) The structure of the neutron as a hadronic bound state of a proton and an electron; and
- 3) The validity of Santilli's isorelativity for the characterization of the hadronic structure, with particular reference to validity of the Poincaré-Santilli isosymmetry and related isorenormalizations (see next section).⁴⁰

ABSENCE OF QUARK AND NEUTRINO CONJECTURES

The lack of quark conjectures was a primary motivation of model (6.2.91), since its primary intent was to reduce the constituents of the neutron to conventional,, physical, massive particles actually existing in our spacetime.

The lack of neutrino conjectures should also be noted, since a direct consequence of the spin structure of Figure 6.23. In essence, paper [95] established that the historical conjecture of the neutrino originated from the inability by quantum mechanics to represent half-odd-integer angular momenta because, as soon as the latter are admitted for the electron inside the proton, the neutron does indeed originate from a compressed hydrogen atom without any need of conjecturing undetectable hypothetical particles.

Note that the lack of need for neutrino conjectures is specifically referred to the neutron *synthesis*, because the neutron *decay* is a separate problem requiring separate analysis presented later on.

SUPPRESSION OF THE ATOMIC MASS SPECTRRUM

As it was the case for the π^0 , the hadronic structure model of the neutron suppressed the conventional atomic spectrum of energy down to one, and only one, energy level, that of the neutron. All excited states are, therefore, of *quantum* nature. In this way, the neutron does indeed result to be a compressed hydrogen atom according to Rutherford's historical conception [91] (see Figure 6.24).

The industrial and scientific implications of the above features are far reaching. On industrial grounds, the knowledge of the numerical value of the isorenormalized rest energy of the electron will turn out to be crucial for the conception and development of mechanisms for the *stimulated decay of the neutron*, as one mechanism to utilize its energy.

On scientific grounds, the above features eliminate current beliefs on "neutron resonances" (see the Particle Data) and establish for hadrons too the historical teaching of nuclear, atomic and molecular physics according to which *the number*

⁴⁰The author cannot describe the *thrill of discovery* caused by this and various other moments felt during the scientific journey presented in these volumes.

of actual constituents increases with mass, as shown in more details in a next section.

NEARLY AT REST AND NEARLY FREE CONSTITUENTS A result of Ref. [95] particularly significant for possible industrial applications is that *the isoelectron is nearly at rest*, evidently in view of the very small value of the hadronic kinetic energy. This implies that the "missing energy" of 0.78 MeV is embedded in the isorenormalization of the electron rest energy. In turn, such a feature is crucial to predict and test mechanisms for possible stimulated decay of the neutron [112].

Similarly, paper [95] established that *the isoelectron is nearly free*, due to the very small value of the hadronic binding energy, by confirming the similar result by the original proposal [14] for the structure of the π^0 . This second result is also important for [possible industrial applications because it confirms the possibility of producing free the neutron constituents with one mechanism or another, as we shall see [112].

6.2.8 Relativistic Structure Model of the Neutron as a Hadronic Bound State of a Proton and an Electron

6.2.8.A Introduction

In the preceding section, we have reviewed Santilli's paper [95] of 1990 achieving the first known, nonrelativistic, exact and (time) invariant representation of *all* characteristics of the neutron as a hadronic bound state of a proton and an electron. The studies were conducted following Rutherford's legacy [91] on the synthesis of the neutron from a hydrogen atom in the core of a matter star

$$H = (p^+, e^-)_{qm} \rightarrow n = (\hat{p}^+, \hat{e}^-)_{hm}. \quad (6.2.109)$$

and were centered on the impossibility that the permanently stable proton and electron "disappear" from the universe at the time of the synthesis just to please organized interests on quantum mechanics (qm) and Einsteinian doctrines and required the prior construction of the covering hadronic mechanics (hm) and relativity specifically conceived for the problem at hand. In the preceding section we also reviewed the first achievement, also in paper [95], of a nonrelativistic, exact and invariant representation of *all* characteristics of the antineutron as a bound state of an antiproton and a positron, following the synthesis from an anti-hydrogen atom in the core of an antimatter star

$$\bar{H} = (p^-, e^+)_{qm} \rightarrow \bar{n} = (\hat{p}^-, \hat{e}^+)_{hm}. \quad (6.2.110)$$

This section is devoted to a verbatim review of Santilli's paper [96] of 1996 achieving the first relativistic, exact and (time) invariant representation of *all*

characteristics of the neutron and of the antineutron according to the above syntheses.

In the hope of minimizing the predictable posturing of judging new problems with old knowledge, let us begin with the identification of the rather dramatic differences between the structure of the hydrogen atom and that of the neutron. It is hoped in this way readers will see their disqualification as serious scientists in the event they venture judgments on the extremely complex problem of the neutron structure via the use of old and decrepit mathematical and physical knowledge.⁴¹

As set in the history of physics, the structure of the hydrogen atom is characterized by action-at-a-distance interactions derivable from a potential between the proton and the electron assumed as being point-like, a fully acceptable abstraction in this case thanks to motion in vacuum at mutual distances much bigger than the size of the particles. Additionally, the (absolute value of) the binding energy of the hydrogen atom is quite small compared to its total energy. In view of these and other features, *quantum mechanics did achieve an exact and invariant representation of all features of the hydrogen atom via the sole knowledge of the Hamiltonian.*

The structure of the neutron is dramatically different than the above century-old lines. To begin, the neutron is one of the densest media measured in laboratory to date; point-like wavepackets do exist in academic manipulations for preset personal gains, but do not exist in the physical reality; and the size of all wavepackets is of the same order of magnitude of the size of the neutron itself. Hence, whatever the constituents, they must be in a state of total mutual penetration of their wavepackets and/or their charge distribution.

The latter conditions cause the emergence of the old legacy that strong interactions are nonlinear (in the wavefunction), nonlocal-integral and nonpotential-nonhamiltonian, for which representation the construction of hadronic mechanics was proposed [14]. At any rate, any attempt at reducing the conditions of total mutual penetration to point like abstractions, for the evident studious intent of preserving quantum mechanics and Einsteinian doctrines, is outside the boundary of serious science.⁴²

⁴¹In reading this section one should keep in mind the extreme difficulties experienced by Santilli in the publication of paper [96], denounced in the footnotes of Section 6.2.1, which difficulties eventually lead Santilli to the publication of paper [96] in a remote, yet scientifically serious journal in China. In view of the huge scientific and social implications, the difficulties here denounced constitute one of the strongest evidence on the deplorable condition of physical research under public financial support currently existing, with due exceptions, in the United States of America, England, France, Germany, Sweden, Russia, and other countries.

⁴²We assume the reader has some technical knowledge of the fact that quantum mechanics can solely represent particles in their point-like abstractions, and that the current attempts of adding at least one dimension via the so-called *string theories* are afflicted by catastrophic mathematical and physical inconsistencies studied in Section 6.1.6 (see Ref. [86] for specific studies). The deplorable condition of physical

Hence, the lack of exact character of quantum mechanics for the structure of the neutron is beyond credible doubt, the only debatable issue being the selection of the broader mechanics achieving an exact and (time) invariant representation of *all* characteristics of the neutron, in the same way as quantum mechanics achieved an exact and (time) invariant representation of all characteristics of the hydrogen atom.

The structure of the neutron is rendered much more complex by additional very peculiar aspects, such as the fact that synthesis (6.2.109) requires 0.78 MeV of *positive* binding energy (Section 6.2.2) under which the Schrödinger equation is no longer physically significant. Additionally, it is clear from the calculations and verifications of the preceding sections that binding energies due to potential interactions, such as those of Coulomb origin, are about 10^{-5} smaller than contributions from the strong interactions responsible for the neutron structure, thus being ignorable. Any belief of the "exact" character of Einsteinian doctrines under these conditions would be sheer scientific corruption.

In summary, the technical difficulties (whose solution required decades of laborious efforts) inherent in the problem considered are given by the facts that *any serious study of the structure of the neutron requires not only the abandonment of quantum mechanics and special relativity in favor of a suitable covering discipline, but also the achievement of an exact and invariant representation of all characteristics of the neutron without any use of any potential or Hamiltonian at all.*

The biggest mental obstacle for the understanding of this section is, therefore, due to the predictable expectation of the use of one or another potential for the representation of the neutron structure while, as we shall see, the exact and invariant representation of synthesis (6.2.109) has been achieved without any use nowhere of any potential or Hamiltonian. This is a necessary condition for consistency because the dominant forces are those of contact, zero-range type due to total mutual penetration of the constituents. The treatment of these interactions with any potential would then be equivalent, for instance, to representing with a potential the resistive forces experienced by a satellite during re-entry in Earth's atmosphere, thus exiting all boundaries of physics.

Under the above premises, the *sole* quantitative representation of synthesis (6.2.109) known to Santilli was the construction of a *new* geometry, relativity and mechanics specifically conceived for the problem considered, while keeping a kilometeric distance from the widespread opposite trend of adapting nature to pre-existing doctrines.

research under public financial support is further documented by the fact that these inconsistencies, even though published in serious refereed journals, continue in being ignored by organized interests in the field, rather than being disproved in equally refereed journals.

As we shall see, Ref. [96] achieved several advances *prior* to addressing synthesis (6.2.109), including the construction, specifically for the neutron structure, of: the Minkowski-Santilli isogeometry; Santilli isorelativity; the Poincaré-Santilli isosymmetry; the isospinorial covering of the Poincaré-Santilli isosymmetry; the Dirac-Santilli isoequatio; and the consequential isorenormalizations of the rest energy, angular momenta, and magnetic moments of the neutron constituents.

As set in the history of science, the conventional Dirac equation for the hydrogen atom represents one electron under the external field of a proton. A fundamental result achieved for the first time by Santilli in paper [96] is that the isotopic lifting of Dirac's equation represents one electron, this time, totally immersed within the hyperdense medium inside the proton considered as external. By recalling that Dirac's equations allows the treatment of both particles and antiparticles (a feature evidently persisting under isotopies), Ref. [96] provided the first known, joint isorelativistic structure model of both the neutron and the antineutron according to syntheses (6.2.109) and (6.2.109).

On historical grounds, Santilli pointed out in Ref. [96] that, quite intriguingly, the technically most difficult problem (mutation of the total angular momentum of the electron down to the value zero) was first solved by P. A. M. Dirac in two of his last papers [13,114]. These papers remained vastly ignored by orthodox physics due to their excessive departures from preferred lines, while, by contrast, the same papers received primary attention by Santilli who quoted and reviewed them in various works (see, e.g., EHM, Volume II). Hence, an objective of this section is to establish the important historical fact that, even though without his knowledge, Dirac himself established the foundations for the quantitative treatment of the proton and the electron as actual physical constituents of the neutron.

It should be indicated that, besides Diracs papers [113,114], the literature in the field is truly large because Rutherfords legacy has stimulated countless studies since its inception of 1920. However, the greatest number of these studies have been conducted via quantum mechanics and, as such, they are ignored here to prevent a prohibitive length. A very limited number of studies have been conducted via the use of broader mechanics other than hadronic mechanics, but they represent only some, rather than all, characteristics of the neutron and additionally suffer the catastrophic inconsistencies typical of all nonunitary theories on a conventional Hilbert space (Section 6.1.6). Consequently, inconsistent studies are equally ignored to avoid a prohibitive length of this section.

We would like to apologize to the author of these efforts for the inability of even a partial reviews to prevent discriminatory selections due to their number, and

recommend interested historians to conduct a comprehensive review of all studies conducted to date on the structure of the neutron along Rutherford's legacy.⁴³

The author would gratefully appreciate the indication, for proper quotation in future editions of this volume, of studies on the structure of the neutron as a bound state of a proton and an electron under the condition that: 1) they were published *prior* to 1990; 2) they are quantitative, rather than conceptual-epistemological; and 3) they achieve an exact and invariant representation of *all* characteristics of the neutron, since the representation of only some of them may bypass central issues.

6.2.8.B Poincaré-Santilli isosymmetry for the Neutron and its Isodual for the Antineutron

For the description of the dynamics of an electron orbiting in vacuum around a proton in the hydrogen atom, we assume the exact validity of the conventional Minkowski spacetime $\hat{M}(x, \eta, R)$ with local coordinates $x = (x^\mu) = (x^1, x^2, x^3, x^4)$, $x^4 = c_o \times t$, where c_o is the speed of light in vacuum, with metric $\eta = \text{Diag.}(1, 1, 1, -1)$, unit $I = \text{Diag.}(1, 1, 1, 1)$, field of real numbers $R(n, +, \times)$ with basic unit I , invariant $(x - y)^2 = [(x^\mu - y^\mu) \times \eta_{\mu\nu} \times (x^\nu - y^\nu)] \times I \in R$, and conventional Poincaré symmetry $P(3.1)$ with generators $J_{\mu\nu}$, P_μ and symmetry transformations hereinafter assumed to be known.⁴⁴

A fundamental assumption of isorelativistic hadronic mechanics to achieve a representation of synthesis (6.2.109) without any potential or Hamiltonian, is that the transition of the electron from motion in vacuum to motion within a

⁴³The author has invited Cynthia Whitney, Editor of *Galilean Electrodynamics*, to organize one or more volumes of papers on syntheses (6.2.109) and (6.2.110). Interested participants are encouraged to send their contribution directly to Whitney, under the condition that they are specifically devoted to structure models of the neutron and/or antineutrons in *with the [proton and the electron as the actual physical constituents]*.

⁴⁴Remember from Chapter 3 that the field R normally used for special relativity throughout the 20-th century is that with the trivial unit 1, in which case the invariant is given by

$$(x - y)^2 = (x^\mu - y^\mu) \times \eta_{\mu\nu} \times (x^\nu - y^\nu), \quad (a)$$

and the Poincaré symmetry is believed to be 10-dimensional. By contrast, the assumption of the unit of the base field R to coincide with the 4-dimensional unit of the Poincaré symmetry, requires the invariant to have the form

$$(x - y)^2 = [(x^\mu - y^\mu) \times \eta_{\mu\nu} \times (x^\nu - y^\nu)] \times I, \quad (b)$$

as a condition for said invariant to be a scalar, that is, an element of R . In turn, the latter correct way of writing the invariant allows the discovery of the 11-th dimension of the Poincaré symmetry,

$$\begin{aligned} (x - y)^2 &= [(x^\mu - y^\mu) \times \eta_{\mu\nu} \times (x^\nu - y^\nu)] \times I = \\ &= \{(x^\mu - y^\mu) \times (n^2 \times \eta_{\mu\nu}) \times (x^\nu - y^\nu)\} \times (n^{-2} \times I), \quad n \in R, \quad n \neq 0. \end{aligned} \quad (c)$$

Admittedly, at the elementary level of special relativity, alternatives (a) and (b) are of marginal relevance. However, at the isotopic level, a number of inconsistencies emerge in the event the basic unit of the field is selected as being different than the basic unit of the symmetry. This is precisely the feature that permitted Santilli to discover the 11-th dimension of the conventional Poincaré symmetry [5e,5f].

physical medium causes an alteration of spacetime called *mutation*. This feature is mathematically represented with the the lifting of the Minkowski metric η into a metric $\hat{\eta}$ with an arbitrary functional dependence on local coordinates x , velocities v , accelerations a , energy E , density d , temperature τ , wave function ψ , their derivatives $\partial\psi$, and any needed additional variable,

$$\eta = (\eta_{\mu\nu}) = \text{const.} \rightarrow \hat{\eta} = (\hat{\eta}_{\mu\nu}) = \hat{\eta}(x, v, a, E, d, \tau, \psi, \partial\psi, \dots), \quad (6.2.111)$$

under a number of regularity conditions identified below assuring that $\hat{\eta}$ admits η as a particular case. This condition is necessary for a quantitative representation of the neutron decay in which we have the transition from the isoelectron on a generalized spacetime with metric $\hat{\eta}$ to the ordinary electron in our spacetime with metric η .

An evident consequential condition is that the signature of $\hat{\eta}$ is the same as that of η , namely, $Sign \hat{\eta} = (1, 1, 1, -1)$. Hence, the generalized metric must admit the factorization into the Minkowski metric multiplied by a nonsingular 4×4 -dimensional metric denoted in the field with the symbol \hat{T}

$$\hat{\eta} = (\hat{\eta}_{\mu\nu}) = \hat{T} \times \eta = (\hat{T}_{\mu}^{\rho}(x, v, a, E, d, \tau, \psi, \partial\psi, \dots) \times \eta_{\rho\nu}), \quad (6.2.112a)$$

$$Det \hat{T} \neq 0. \quad (6.2.112b)$$

Since the neutron is considered isolated from the rest of the universe, the above lifting must preserve *conventional* total conservation laws, namely, the total linear and angular momentum of the neutron must be conserved and the motion of its center-of-mass must be uniform.

As it is well known, a necessary and sufficient condition for the verification of these conservation laws is that *the generalized symmetry must conserve the conventional generators $J_{\mu\nu}$, P_{μ}* . The *sole* possible generalization of the Poincaré symmetry meeting the above requirement is the *Poincaré-Santilli isosymmetry $\hat{P}(3.1)$* whose construction specifically formulated for the neutron structure (6.2.109) was done in Ref. [96] and can be outlined as follows.

The main idea of $\hat{P}(3.1)$ [5e,5f] is the reconstruction of $P(3.1)$ with respect to a generalization of its unit I assumed as being the *inverse* of the mutation of the metric,

$$\hat{I} = \hat{I}(x, v, a, E, d, \tau, \psi, \partial\psi, \dots) = 1/\hat{T} > 0, \quad (6.2.113)$$

in which case \hat{I} is called the *isounit*, \hat{T} is called the *isotopic element*, and the positive-definite character is assumed to preserve the topology of I . The positive-definite character is also assumed to separate the Poincaré-Santilli isosymmetry $\hat{P}(3.1)$ for the neutron from the isodual isosymmetry $\hat{P}^d(3, 1)$ for the antineutron, the latter requiring a negative-definite unit as assumed to be known from Volume I.

The assumption of \hat{I} as the basic unit requires the reconstruction of the field R as Santilli isofield $\hat{R}(\hat{n}, \hat{+}, \hat{\times})$ (Section 3.2), with isonumbers $\hat{n} = n \times \hat{I}$, isosum trivially coinciding with the conventional sum, $\hat{+} \equiv +$, and isoproduct $\hat{n} \hat{\times} \hat{m} = \hat{n} \times \hat{I} \times \hat{m}$, under which \hat{I} is the correct left and right unit.

The latter condition requires, for consistency, the isotopic lifting of the Minkowski spacetime into the Minkowski-Santilli isospacetime $\hat{M}(\hat{x}, \hat{\eta}, \hat{R})$ in which the local coordinates, to be isonumbers, must have the form $\hat{x} = x \times \hat{I}$. Similarly, for the elements of the isometric being isoscalars, they must have the form $\hat{G}_{\mu\nu} = \hat{\eta}_{\mu\nu} \times \hat{I}$ herein assumed.

Ref. [96] only considered the case of a diagonal isounit and isotopic element, because fully sufficient for the structure of the neutron, with explicit form

$$\begin{aligned} \hat{I} &= \text{Diag.}(b_1^{-2}, b_2^{-2}, b_3^{-2}, b_4^{-2}) \times e^{(\psi_e/\hat{\psi}_e) \times \int dr^3 \hat{\psi}^\dagger(r)_{p\downarrow} \times \hat{\psi}(r)_{e\uparrow}} = \\ &= \text{Diag.}(n_1^2, n_2^2, n_3^2, n_4^2) \times e^{(\psi_e/\hat{\psi}_e) \times \int dr^3 \hat{\psi}^\dagger(r)_{p\downarrow} \times \hat{\psi}(r)_{e\uparrow}} \end{aligned} \quad (6.2.114a)$$

$$\begin{aligned} \text{hatr}T &= \text{Diag.}(b_1^2, b_2^2, b_3^2, b_4^2) \times e^{(\psi_e/\hat{\psi}_e) \times \int dr^3 \hat{\psi}^\dagger(r)_{p\downarrow} \times \hat{\psi}(r)_{e\uparrow}} = \\ &= \text{Diag.}(n_1^{-2}, n_2^{-2}, n_3^{-2}, n_4^{-2}) \times e^{(\psi_e/\hat{\psi}_e) \times \int dr^3 \hat{\psi}^\dagger(r)_{p\downarrow} \times \hat{\psi}(r)_{e\uparrow}} \end{aligned} \quad (6.2.114b)$$

where the $b_\mu = 1/n_\mu, \mu = 1, 2, 3, 4$ are the *characteristic quantities of the proton*. The reader is assumed to know that $b_k = 1/n_k, k = 1, 2, 3$ provide a geometrization of the *shape* of the proton, while $b_4 = 1/n_4$ provide a geometrization of its *density*, all quantities being normalized to the value 1 for the vacuum.

At this initial states of the analysis, the characteristic quantities of the proton are assumed as being local variables, $b_\mu = b_\mu(x, v, a, d, \tau, \psi, \partial\psi, \dots)$, for the specific purpose of illustrating the independence of the Poincaré-Santilli isosymmetry from said local functional dependence.

Under the above assumptions, the basic isoinvariant of the neutron is then given by

$$\begin{aligned} (\hat{x} - \hat{y})^{\hat{2}} &= (\hat{x}^\mu - \hat{y}^\mu) \hat{\times} \hat{G}_{\mu\nu} \hat{\times} (\hat{x}^\nu - \hat{y}^\nu) = \\ &= [(x^\mu - y^\mu) \times \hat{\eta}_{\mu\nu} \times (x^\nu - y^\nu)] \times \hat{I} = \\ &= [(x^1 - y^1)^2 \times b_1^2 + (x^2 - y^2)^2 \times b_2^2 + (x^3 - y^3)^2 \times b_3^2 - (x^4 - y^4)^2 \times b_4^2] \times \hat{I} = \\ &= [(x^1 - y^1)^2/n_1^2 + (x^2 - y^2)^2/n_2^2 + (x^3 - y^3)^2/n_3^2 - (x^4 - y^4)^2/2_4] \times \hat{I}, \end{aligned} \quad (6.2.115)$$

where the exponent of Eqs. (6.2.114) can be considered embedded in the characteristic quantities due to their arbitrary functional dependence, or ignored at the moment, due to its cancellation by the isounit.

Note that *isoinvariant (6.2.115) contains as particular cases all infinitely possible Riemannian, Finslerian, as well as any other possible, nonsingular line element with signature (+, +, +, -)*. Hence, Ref. [96] constructed the universal symmetry for all these infinitely possible line elements.

The transformations leaving invariant isoseparation (6.2.115) can be written (see Eqs. (3.4) page 183, Ref. [96])

$$\hat{x}' = \hat{\Lambda}(\hat{w}) \hat{\times} \hat{x}, \quad \hat{x}' = \hat{x} + \hat{A}, \quad (6.2.116)$$

$$\hat{\Lambda}^\dagger \times \hat{\eta} \times \hat{\Lambda} = \Lambda \times \hat{\eta} \times \Lambda^\dagger = \hat{I} \times \hat{\eta} \times \hat{I}, \quad (6.2.116b)$$

$$\widehat{Det} \hat{\Lambda} = Det (\Lambda \times \hat{T}) = \pm \hat{I}, \quad (6.2.116c)$$

where the quantity \hat{A} is identified below and $\hat{w} = w \times \hat{I}$ represents the isoparameters.

The isoconnected component of $\hat{P}(3.1)$ is characterized by

$$\widehat{Det} \Lambda = +\hat{I}, \quad (6.2.117a)$$

$$\hat{P}^o(3.1) = \hat{S}O(3.) \times \hat{A}(3.1), \quad (6.2.117b)$$

with explicit form of the *finite isotransforms* (Eqs. (3.5), page 184, Ref. [96])

$$\begin{aligned} \hat{S}O(3.1) : \quad \hat{x}' &= (\hat{e}^{i \times J_k \times w_k}) \hat{\times} \hat{x} \hat{\times} (\hat{e}^{-i \times J_k \times w_k}) = \\ &= \left[\left(e^{i \times J_k \times \hat{T} \times w_k} \right) \times x \times \left(e^{-i \times w_k \times \hat{T} \times J_k} \right) \right] \times \hat{I}, \end{aligned} \quad (6.2.118a)$$

$$\begin{aligned} \hat{A}(3.1) : \quad \hat{x}' &= (\hat{e}^{i \times P_\mu \times a_\mu}) \hat{\times} \hat{x} \hat{\times} (\hat{e}^{-i \times P_\mu \times a_\mu}) = \\ &= \left[\left(e^{i \times P_\mu \times \hat{T} \times a_\mu} \right) \times x \times \left(e^{-i \times a_\mu \times \hat{T} \times P_\mu} \right) \right] \times \hat{I}, \end{aligned} \quad (6.2.118b)$$

where $(J_k) = (J_{\mu\nu})$, P_μ , w_k , a_μ , $k = 1, 2, 3, 4, 5, 6$, $\mu, \nu = 1, 2, 3, 4$, are conventional quantities of the Poincaré symmetry, and we have used the isoexponentiation (Section 3.2)

$$\hat{e}^X = (e^{X \times \hat{T}}) \times \hat{I} = \hat{I} \times (e^{\hat{T} \times X}), \quad (6.2.119)$$

The reformulation of finite isotransforms (6.1.118) in terms of isogenerators $\hat{J}_k = J_k \times \hat{I}$, $\hat{P}_\mu = P_\mu \times \hat{I}$ is left as an instructive exercise for the interested reader, and assumed hereon.

The computation of the *infinitesimal isotransforms* from the preceding finite forms is elementary, yielding the *Lie-Santilli isoalgebra* (Eqs. (3.6), Page 184, Ref. [96])

$$\begin{aligned} [J_{\mu\nu}, \hat{J}_{\alpha\beta}] &= J_{\mu\nu} \times \hat{T} \times J_{\alpha\beta} - J_{\alpha\beta} \times \hat{T} \times J_{\mu\nu} = \\ i \times (\hat{\eta}_{\nu\alpha} \times J_{\beta\mu} - \hat{\eta}_{\mu\alpha} \times J_{\beta\nu} - \hat{\eta}_{\nu\beta} \times J_{\alpha\nu} + \hat{\eta}_{\mu\beta} \times J_{\alpha\nu}), \end{aligned} \quad (6.2.120a)$$

$$\begin{aligned} [J_{\mu\nu}, \hat{P}_\alpha] &= J_{\mu\nu} \times \hat{T} \times P_\alpha - P_\alpha \times \hat{T} \times J_{\mu\nu} = \\ &= i \times (\hat{\eta}_{\mu\alpha} \times P_\nu - \hat{\eta}_{\nu\alpha} \times P_\mu), \end{aligned} \quad (6.2.120b)$$

$$[P_\mu, \hat{P}_\nu] = P_\mu \times \hat{T} \times P_\nu - P_\nu \times \hat{T} \times P_\mu = 0. \quad (6.2.120c)$$

The initiated reader is aware of the deep meaning of the seemingly innocuous isocommutators (6.2.120c), In fact, the components of the linear momentum *do not* commute when defined over a space with an explicit functional dependence on the local variables. Their isocommutativity then signals the elimination of curvature for brooder vistas.

The *Casimir-Santilli isoinvariants* were also computed in Eqs. (3.7), page 184, Ref. [96], via the use of isocommutators (6.2.120) and can be written

$$\hat{C}^{(0)} = \hat{I} \quad (6.2.121a)$$

$$\hat{C}^{(1)} = \hat{P}^{\hat{2}} = \hat{P} \hat{\times} \hat{P} = (\hat{\eta}^{\mu\nu} \times \hat{P}_{\mu} \times \hat{T} \times \hat{P}^{\nu}) \times \hat{I}, \quad (6.2.121b)$$

$$\hat{C}^{(2)} = \hat{W} \hat{\times} \hat{W}, \quad \hat{W}_m u = \epsilon_{\mu\alpha\beta\rho} J^{\alpha\beta} \times \hat{T} \times P_{\rho}. \quad (6.2.121d)$$

The explicit form of the isotransformations along the third space axis is then given by:

1) **isorotations** [5a,5b,5c,5d]

$$x^{1'} = x^1 \times \cos[\theta \times (\hat{\eta}_{11} \times \hat{\eta}_{22})^{1/2}] - x^2 \times \hat{\eta}_{22} \times \hat{\eta}_{11}^{-1} \times \sin[\theta \times (\hat{\eta}_{11} \times \hat{\eta}_{22})^{1/2}], \quad (6.2.122a)$$

$$x^{2'} = x^1 \times \hat{\eta}_{11} \times \hat{\eta}_{22}^{-1} \times \sin[\theta \times (\hat{\eta}_{11} \times \hat{\eta}_{22})^{1/2}] + x^2 \times \cos[\theta \times (\hat{\eta}_{11} \times \hat{\eta}_{22})^{1/2}]. \quad (6.2.122b)$$

2) **Lorentz-Santilli isotransforms** [5e,5f]

$$x^{1'} = x^1, \text{ eqno}(6.2.123a)$$

$$x^{2'} = x^2, \quad (6.2.123b)$$

$$\begin{aligned} x^{3'} &= x^3 \times \cosh[v \times (\hat{\eta}_{33} \times \hat{\eta}_{44})^{1/2}] - \\ &- x^4 \times \hat{\eta}_{44} \times (\hat{\eta}_{33} \times \hat{\eta}_{44})^{-1/2} \times \sinh[v \times (\hat{\eta}_{33} \times \hat{\eta}_{44})^{1/2}] = \\ &= \hat{\gamma} \times (x^3 - \hat{\beta} \times \frac{b_4}{b_3} \times x^4), \end{aligned} \quad (6.2.123c)$$

$$\begin{aligned} x^{4'} &= -x^3 \times \hat{\eta}_{33} \times (\hat{\eta}_{33} \times \hat{\eta}_{44})^{-1/2} \times \sinh[v \times (\hat{\eta}_{33} \times \hat{\eta}_{44})^{1/2}] + \\ &+ x^4 \times \cosh[v \times (\hat{\eta}_{33} \times \hat{\eta}_{44})^{1/2}] = \\ &= \hat{\gamma} \times (x^4 - \hat{\beta} \times \frac{b_3}{b_4} \times x^3), \end{aligned} \quad (6.2.123d)$$

$$\hat{\beta}^2 = \frac{v_k \times \hat{\eta}_{kk} \times v_k}{c_o \times \hat{\eta}_{44} \times c_o} = \frac{v_k \times b_k^2 \times v_k}{c_o \times b_4^2 \times c_o}, \quad (6.2.123e)$$

$$\hat{\gamma}^2 = \frac{1}{1 - \hat{\beta}^2}. \quad (6.2.123f)$$

3) isotranslations [96]

$$x'_{\mu} = x_{\mu} + A_{\mu} \quad (6.2.124a)$$

$$A_{\mu} = A_{\mu}(x, v, a, E, d, \tau, \psi, \partial\psi, \dots) = a_{\mu} \times \{\hat{\eta}_{\mu\mu} + \\ + a^{\alpha} \times [\hat{\eta}_{\mu\mu}, J_{\mu\alpha}]/1! + a^{\alpha} \times a^{\beta} \times [\hat{\eta}_{\mu\mu}, J_{\mu\alpha}], J_{\mu\beta}]/2! + \dots\}; \quad (6.2.124b)$$

4) space and time isoinversions [96]

$$x' = \pi \times x = (-x^k, x^4), \quad (6.2.125a)$$

$$x' = \pi_t \times x = (x^k, -x^4); \quad (6.2.125b)$$

5) isoselftransforms [5e,5f,96]

$$\hat{\eta} \rightarrow \hat{\eta}' = \hat{n} \hat{\times} \hat{\eta}, \quad \hat{I} \rightarrow \hat{I}' = \hat{n}^{-1} \hat{\times} \hat{I}, \quad \hat{n} \in \hat{R}, \quad n \neq 0, \quad (6.2.126)$$

a property of fundamental relevance for gravitation, grand unification and other basic issues (see Chapter 14).

The following comments presented in ref. [96] should be reviewed:

A) It is easy to see the local isomorphism $\hat{P}(3.1) \approx P(3.1)$ for all positive-definite isounits. Hence, the Lorentz-Poincaré *transformations* are 'inapplicable' (rather than violated) for the neutron structure (6.2.109), but *the Lorentz-Poincaré symmetry remains exact*, and only subjected to the broadest possible *realization* preserving conventional total quantities.

B) The physically most salient differences between the Poincaré symmetry and its isotopic covering is that the former solely applies for linear, local-differential and potential-Hamiltonian interactions, while the latter includes the preceding interactions and additionally tests nonlinear, nonlocal-integral and nonpotential-nonhamiltonian interactions as expected in conditions of deep mutual penetration of the wavepackets and/or charge distribution of particles.

C) The Minkowski-Santilli isospace provides a *geometric unification* of all infinitely possible spaces with signature $(+, +, +, -)$, thus including all possible Riemannian, Finslerian and other spaces (see Chapter 3 for details).

D) The Poincaré-Santilli isosymmetry is *directly universal* for all possible (non-singular) line elements with signature $(+, +, +, -)$, thus being directly universal for all possible Riemannian, Finslerian and other line elements with said signature.

E) As it is well known, no connection was considered throughout the 20-th century between strong and gravitational interactions, trivially, because strong interactions solely occur at distances of 1 *fm*, while gravitational models studies in the 20-th century are restricted to exterior long distance problems. However, *no distinction can be made at this stage of our studies between strong and gravitational interactions* because we are studying the interior neutron problem

within the hadronic horizon with 1 *fm* radius. As recalled in Section 6.1.4, Eqs. (6.1.17)-(6.1.19), all Riemannian metrics admit the factorization of the isotopic element of type (6.2.112), thus reaching line element (6.2.15).

The *Poincaré-Santilli isodual isosymmetry*

$$\hat{P}^d(3.1) = \hat{O}^d(3.1) \times \hat{A}(3.1) \quad (6.2.127)$$

for the characterization of the structure of the antineutron according to model (6.2.110) can be easily constructed from the above derivation via the *isodual map* (Chapter 2), here expressed for an arbitrary quantity

$$\begin{aligned} A(x, v, a, E, d, \psi, \partial\psi, \dots) &\rightarrow A^d(x^d, v^d, a^d, E^d, d^d, \psi^d, \partial\psi^d, \dots) = \\ &= -A^\dagger(-x^\dagger, -v^\dagger, -a^\dagger, -E^\dagger, -d^\dagger, -\psi^\dagger, \partial^\dagger\psi^\dagger, \dots), \end{aligned} \quad (6.2.128)$$

applied to the *totality* of the formalism, including units, numbers, fields, spaces, algebras, symmetries, etc.

6.2.8.C Santilli Isorelativity for the Neutron and its Isodual for the Antineutron

Deviations from the conventional Minkowskian spacetime causes necessary compatible deviations from special relativity. Santilli covering isorelativity [4,5] according to Isoaxioms I to V, Eqs. (6.1.11) to (6.1.16), was adopted for the interior of the neutron in Ref. [96] for synthesis (6.2.109), the isodual isorelativity being adopted for the synthesis of the antineutron (9.2.110). The same assumptions are adopted hereon. The following comments were presented in Ref. [96] and their indication may of value here:

A) The main assumption of isorelativity for the interior of the neutron is the abandonment of the speed of light as the basic invariant, and its replacement with the maximal causal speed (6.1.11). The assumption was mandated by numerous facts, such as: the expectation of physical media opaque to light, in which case any use of the speed of light as the basic invariance is nonsensical; clear experimental evidence in which particles move faster than the local speed of light within physical media, such as water, in which case the assumption of the speed of light as the basic invariant cause violation of causality; and other facts.

This central assumption will be derived later on from first axiomatic principles, and submitted to additional confrontation with experimental data. At this point, we merely indicate that the assumption can be easily derived via the derivative of space with respect to time on the isocone of causal speeds in the (3,4)-plane

$$\begin{aligned} \hat{d}\hat{x}^2 &= \hat{d}\hat{x}^3 \hat{\times} \hat{d}\hat{x}^3 - \hat{d}\hat{x}^4 \hat{\times} \hat{d}\hat{x}^4 = \\ &= (dx^3 \times b_3^2 \times dx^3 - dx^4 \times b_4^2 \times dx^4) \times \hat{I} = \end{aligned}$$

$$= (dx^3 \times dx^3/n_3^2 - dx^4 \times dx^4/n_4^2) \times \hat{I} = 0, \quad (6.2.129)$$

that, for b_3, b_4 independent from x , yields [5,96]

$$V_{max} = \left| \frac{dr}{dt} \right|_{max} = c_o \times \frac{b_4}{b_3} = c_o \times \frac{n_3}{n_4}. \quad (6.2.130)$$

V_{max} is essentially the maximal possible speed of the electron when a physical constituent of the neutron, that is, the maximal orbital speed of the electron when trapped within the hyperdense proton and constrained to rotate with its spin. When the neutron decays and the electron is expected, we have $b_3 = b_4 = 1$ and the conventional value c_o is recovered as maximal causal speed in vacuum.

B) The structure of the neutron is described in Ref. [96] via the use of our notions of time and length and their related units, with the understanding that the intrinsic time of the neutron, the *neutron isotime* is given by

$$\hat{t}_n = t \times \hat{I}_t, \quad \hat{I}_t = b_4^{-2} = n_4^2, \quad (6.2.131)$$

and the *neutron isolength* along the 3-axis has the expression

$$\hat{\ell}_n = \ell \times \hat{I}_\ell, \quad \hat{I}_\ell = b_3^{-2} = n_3^2, \quad (6.2.132)$$

where t and ℓ are our time and length, respectively.

It is evident that the above defined neutron proper time and proper length are *different* than our own, to such an extent that a perfectly spherical shape assumed in the outside may correspond to a different structure in the inside, trivially, due to possible different values of the space characteristic quantities.

C) Isoaxioms I to V are verified by all experimental evidence considered so far. The objective of this section is, therefore, to show that the same isoaxioms are verified also by the structure of the neutron.

D) When locally defined, that is, defined at a given value of spacetime, *isotransformations are highly nonlinear, thus mapping inertial into noninertial frames*. This is a necessary condition for the admission of unrestricted, thus generally non-Newtonian forces, such as acceleration-dependent forces. It is evident that, under such a nonlinear structure, the center of mass of an isolated neutron cannot have a uniform motion.

E) Since the objective of this section is the achievement of a *global* representation of the neutron structure, *all values of the characteristic quantities are hereon assumed as being averaged to constants, thus regaining the linearity of the isotransforms and their preservation of inertial systems* [96, page 188).

6.2.8.D The Isoselfdual Dirac-Santilli Isoequation

The next important advance presented in Ref. [96] is the construction of the isotopies of Dirac's equation in a way conform to the rules of hadronic mechanics,

today known as the *Dirac-Santilli isoequation*. The resulting isothory is as fundamental for hadronic mechanics as the conventional Dirac equation is for quantum mechanics.

As recalled earlier, the conventional Dirac equation represents an electron moving in vacuum under the electromagnetic field of a proton, as occurring in the hydrogen atom, while the isotopic version represents the same electron when moving within hyperdense media, as occurring in the neutron structure.⁴⁵

Recall that the Schrödinger equation represents indeed the hydrogen atom as a bound state of a proton and an electron, while Dirac's equation *does not* because it solely represents the electron *under the field of the proton considered as external*. To avoid illusory appraisals, the reader should expect the same conceptual setting for the isotopic equation because isotopies are axiom-preserving. Hence, the Dirac-Santilli isoequation represents the dynamics of an electron immersed within the proton *considered as external*.

Additionally, we should recall that the conventional Dirac equation has been misinterpreted throughout the 20-th century as solely representing the electron, since the positron was derived via the so-called "hole theory" or other manipulations. This misinterpretation resulted to be due to the use of basically insufficient mathematical and physical insight.

Hadronic mechanics has identified fundamental flaws in this view, such as the fact that a *4-dimensional irreducible representation of spin 1/2 does not exist*. Consequently, in the eventuality orthodox views were correct, Dirac's equation would represent the electron via a *reducible* representation of spin 1/2, thus implying that the electron is composite.

The advent of the isodual mathematics (Section 2.2) permitted the identification of the property that the conventional *gamma matrices*

$$\gamma^k = \begin{pmatrix} 0 & \sigma_k \\ -\sigma_k & 0 \end{pmatrix}, \quad \gamma^4 = i \times \begin{pmatrix} I_{2 \times 2} & 0 \\ 0 & -I_{2 \times 2} \end{pmatrix}, \quad (6.2.133)$$

characterize the Kronecker product of one irreducible, two-dimensional representation of spin 1/2 time its isodual,

$$\gamma^k = \begin{pmatrix} 0 & \sigma_k \\ \sigma_k^d & 0 \end{pmatrix}, \quad \gamma^4 = i \times \begin{pmatrix} I_{2 \times 2} & 0 \\ 0 & I_{2 \times 2}^d \end{pmatrix}, \quad (6.2.134)$$

thus jointly representing an electron and a positron. In any case, this joint representation is *necessary* to achieve a full scientific democracy for particles

⁴⁵Since the appearance of Ref.s [5,96] there have been studies on the so-called "deformation" of Dirac equation that essentially copy Santilli's result (generally without quotation of their origination) but without formulating the theory on isospaces over isofields (in the illusion of hiding the paternity fraud). These "deformations" are hereon ignored because catastrophically inconsistent, as now familiar.

and antiparticles at all levels, thus including the first quantization here considered. Alternatively, the above features are rigorously represented by the fact that *Dirac's gamma matrices are isoselfdual* (invariant under isoduality) [96].

Under the above clarifications, the construction of the Dirac-Santilli isoequation can be outlined as following. First, ref. [96] identified the *total representation space* of the conventional Dirac equations

$$S_{tot} = \{M_{orb}(x, \eta, R) \times S_{spin}(2)\} \times \{M_{orb}^d(x^d, \eta^d, R^d) \times S_{spin}^d(2)\}, \quad (6.2.135)$$

that resulted in being *twelve-dimensional*, due to the inclusion of the orbital and intrinsic spaces for both the electron and the positron.

Consequently, Ref. [96] assumed the following fundamental, twelve-dimensional, total isospace

$$\hat{S}_{tot} = \{\hat{M}_{orb}(\hat{x}, \hat{\eta}, \hat{R}) \times \hat{S}_{spin}(2)\} \times \{\hat{M}_{orb}^d(\hat{x}^d, \hat{\eta}^d, \hat{R}^d) \times \hat{S}_{spin}^d(2)\}. \quad (6.2.136)$$

The above assumption requires the use of *four different isounits and related isotopic elements*, one pair for each of the four distinct motions,

$$\hat{I}_{tot} = \{\hat{I}_{orb} \times \hat{I}_{spin}\} \times \{\hat{I}_{orb}^d \times \hat{I}_{spin}^d\}. \quad (6.2.137a)$$

$$\hat{T}_{tot}^{-1} = \{\hat{T}_{orb} \times \hat{T}_{spin}\} \times \{\hat{T}_{orb}^d \times \hat{T}_{spin}^d\}, \quad (6.2.137b)$$

with combined total orbital (to) and total spin (ts) expressions for particle and antiparticle

$$\hat{I}_{to} = \hat{I}_{orb} \times \hat{I}_{orb}^d, \quad \hat{I}_{ts} = \hat{I}_{spin} \times \hat{I}_{spin}^d \quad (6.2.138)$$

Ref. [96], Eqs. (6.1, page 189 then constructed the isotopies of Dirac's equation in the most rigorous known way, via the linearization of the second order Casimir-Santilli isoinvariant, Eq. (6.2.121b),

$$\begin{aligned} & (\hat{G}^{\mu\nu} \hat{\times}_{to} \hat{P}_\mu \hat{\times}_{to} \hat{P}_\nu + \bar{m}_{\hat{e}}^2) \hat{\times}_{to} |\hat{\psi}\rangle = \\ & = (\hat{G}^{\mu\nu} \hat{\times}_{to} \hat{\Gamma}_\mu \hat{\times}_{to} \hat{P}_\nu + \hat{i} \hat{\times}_{to} \bar{m}_{\hat{e}}) \hat{\times}_{to} (\hat{G}^{\alpha\beta} \hat{\times}_{to} \hat{\Gamma}_\alpha \hat{\times}_{to} \hat{P}_\beta + \hat{i} \hat{\times}_{to} \bar{m}_{\hat{e}}) \hat{\times}_{to} |\hat{\psi}\rangle = 0, \end{aligned} \quad (6.2.139a)$$

$$\{\hat{\Gamma}_\mu, \hat{\Gamma}_\nu\} = \hat{\Gamma}_\mu \hat{\times}_{to} \hat{\Gamma}_\nu + \hat{\Gamma}_\nu \hat{\times}_{to} \hat{\Gamma}_\mu = \hat{2} \hat{\times}_{to} \hat{G}_{\mu\nu}, \quad (6.2.139b)$$

$$\{\hat{\gamma}_\mu, \hat{\gamma}_\nu\} = \hat{\gamma}_\mu \times \hat{T} \times \hat{\gamma}_\nu + \hat{\gamma}_\nu \times \hat{T} \times \hat{\gamma}_\mu = 2 \times \hat{\eta}_{\mu\nu}, \quad (6.2.139c)$$

$$\hat{\Gamma}_\mu = \hat{\gamma}_\mu \times \hat{I}_{to}. \quad (6.2.139d)$$

where, as shown below

$$\bar{m}_{\hat{e}} = m_e \times c_o \times \frac{b_4}{b_3}. \quad (6.2.140)$$

The above reduction is excessively general for the structure of the neutron. Hence, Ref. [96] assumed the simplified conditions

$$\hat{I}_{to} = 1/\hat{T}_{to} = \hat{I}, \quad \hat{I}_{ts} = I = \text{Diag.}(1, 1), \quad (6.2.141)$$

from which Ref. [96] derived the explicit form of the *isogamma matrices*

$$\hat{\gamma}_k = b_k \times \begin{pmatrix} 0 & \hat{\sigma}_k \\ \hat{\sigma}_k^d & 0 \end{pmatrix}, \quad \hat{\gamma}_4 = i \times b_4 \times \begin{pmatrix} I_{2 \times 2} & 0 \\ 0 & I_{2 \times 2}^d \end{pmatrix}, \quad (6.2.142)$$

where σ^k are the conventional Pauli matrices.

The above expressions then characterize the *Dirac-Santilli isoequation* (Eq. (6.3), p. 190, Ref. [96]),

$$(\hat{G}^{\mu\nu} \hat{\times} \hat{\Gamma}_\mu \hat{\times} \hat{P}_\nu + \hat{i} \hat{\times} \bar{m}_e) \hat{\times} |\hat{\psi}\rangle = (\hat{\eta}^{\mu\nu} \times \hat{\gamma}_\mu \times \hat{P}_\nu + i \times \bar{m}_e) \times \hat{T} \times |\hat{\psi}\rangle = 0. \quad (6.2.143)$$

The understanding of this section requires the knowledge that the structure of the neutron is represented via the above isoequation *without* any need to add electromagnetic potentials. The latter are crucial for the hydrogen atom but their contribution is ignorable for the neutron structure with respect to the much bigger contribution from the strong interactions (see below). At any rate, the addition of said potential is trivial and left to the interested reader.

6.2.8.E Isospinorial Covering of the Poincaré-Santilli Isosymmetry and its Isodual

The next advance achieved in Ref. [96] is the first construction of the *isospinorial covering of the Poincaré-Santilli isosymmetry*

$$\hat{\mathcal{P}}(3.1) = \hat{S}L(2.\hat{C}) \times \hat{\mathcal{A}}(3.1), \quad (6.2.144)$$

via the following realization (Eq. (6.4), page 190, ref. [96])

$$\hat{S}L(2.\hat{C}) : \hat{R}_k = \frac{1}{2} \times \epsilon_{kij} \Gamma_i \hat{\times} \Gamma_j, \quad \hat{S}_k = \frac{1}{2} \times \Gamma_k \hat{\times} \Gamma_4, \quad (6.2.145a)$$

$$\hat{\mathcal{A}}(3.1) : P_\mu. \quad (6.2.145b)$$

The verification by the above generators of commutation rules (6.2.120) is an instructive exercise for the interested reader.

The proof that the Dirac-Santilli isoequation transforms covariantly under $\hat{\mathcal{P}}(3.1)$ is instructive. Equally instructive is the proof of the isoselfduality of Eq. (6.2.143), thus eliminating the need for an isodual image. In turn, this establishes that the true symmetry of the conventional Dirac equation is the isoselfdual symmetry

$$S_{tot} = P(3.1) \times P^d(3.1). \quad (6.2.146)$$

Similarly, the total symmetry of the Dirac-Santilli isoequation is given by the isoselfdual symmetry

$$\hat{S}_{tot} = \hat{\mathcal{P}}(3.1) \hat{\times} \hat{\mathcal{P}}^d(3.1). \quad (6.2.147)$$

The reader's technical knowledge can be tested at this point via the knowledge of the reason for symmetries (6.2.146) and (6.2.147) to be *twenty two dimensional*.

6.2.8.F Isorenormalization of Spin and Angular Momentum

In order to conduct the direct study of the hadronic structure model of the neutron as a bound state of a isoproton and an isoelectron

$$n = (\hat{p}^+, \hat{e}^-)_{hm}, \quad (6.2.148)$$

Ref. [96] studied the mutations of the intrinsic characteristics of the electron when totally immersed inside the proton, a feature called *isorenormalization* in ref. [96] for the first time, with evident isodual image for the antineutron.

Hence, Ref. [96] provided the following realization of the Poincaré-Santilli isosymmetry

$$\hat{O}(3.1) : \hat{L}_k = \epsilon_{kij} \hat{r}_i \hat{\times} \hat{P}_j, \quad \hat{S}_k = \frac{1}{2} \times \epsilon_{kij} \hat{\gamma}_i \hat{\times} \hat{\gamma}_j, \quad (6.2.149a)$$

$$[\hat{L}_i, \hat{L}_j] = \epsilon_{ijk} b_k^{-2} \times \hat{L}_k, \quad (6.2.149b)$$

$$\hat{L}^2 \hat{\times} |\hat{\psi}\rangle = (b_1^{-2} \times b_2^{-2} + b_2^{-2} \times b_3^{-2} + b_3^{-2} \times b_1^{-2}) \times |\hat{\psi}\rangle, \quad (6.2.149c)$$

$$\hat{L}_3 \hat{\times} |\hat{\psi}\rangle = \pm b_1^{-1} \times b_2^{-1} \times |\hat{\psi}\rangle, \quad (6.2.149d)$$

$$\hat{S}^2 \hat{\times} |\hat{\psi}\rangle = \frac{1}{4} \times (b_1^2 \times b_2^2 + b_2^2 \times b_3^2 + b_3^2 \times b_1^2) \times |\hat{\psi}\rangle, \quad (6.2.149e)$$

$$\hat{S}_3 \hat{\times} |\hat{\psi}\rangle = \pm b_1 \times b_2 \times |\hat{\psi}\rangle, \quad (6.2.149f)$$

which realization exhibits the mutations/isorenormalizations of spin and angular momentum *necessary* for the representation of neutron structure.

6.2.8.G Isorenormalization of the Rest Energy

A direct consequence of the mutation of the speed of light,

$$c_o \rightarrow c = c_o \times b_4 = \frac{c_o}{n_4}, \quad (6.2.150)$$

is the isorenormalization of the rest energy of the electron in structure (6.2.148). However, the corresponding mutation

$$E_e = m_e \times c_o^2 \rightarrow E_{\hat{e}} = m_e \times c_o^2 \times b_4^2 = m_e \times \frac{c_o^2}{n_4^2}, \quad (6.2.151)$$

would be *erroneous* because violating causality in physical media whose density is such that $b_4 > b_3$, in which case

$$c_o \times b_4 > c_o \times V_{max} = c_o \times \frac{b_4}{b_3} \quad (6.2.152)$$

At any rate, isorenormalization (6.2.151) would imply that. for the case of water,

$$E_{\hat{e}} \approx \frac{4 \times E_e}{9}, \quad (6.2.153)$$

since in water $b_4 \approx 2/3$. By contrast, for the correct isorenormalization (see below) we must have for an electron traveling in water $E_{\hat{e}} = E_e$ since, as indicated in Section 6.1.4, for water we have $b_4 = b_3$ due to its homogeneity and isotropy.

In view of the above issues, Ref. [96] derived the isorenormalization of the rest energy from primitive isosymmetries. In fact, the isolinear momentum in the Lie-Santilli isoalgebra (6.2.120) has the explicit form, Eq. (5.2), p. 188, Ref. [96]

$$\begin{aligned} \hat{P}_\mu \hat{\times} |\hat{\psi}\rangle &= \hat{P}_\mu \times \hat{T} \times |\hat{\psi}\rangle = -\hat{i} \hat{\times} \hat{\partial}_\mu |\hat{\psi}\rangle = \\ &= -i \times \hat{I}_\mu^\nu \times \partial_\nu |\hat{\psi}\rangle = -i \times b_\mu^{-2} \times \partial_\mu |\hat{\psi}\rangle = -i \times n_\mu^2 \times \partial_\mu |\hat{\psi}\rangle, \quad \text{nosum}, \quad (6.2.154) \end{aligned}$$

with space and time eigenvalues

$$p = (p_\mu) = (m_e \times \hat{\gamma} \times c_o \times \frac{b_4}{b_3} \times v_k, m_e \times \hat{\gamma} \times c_o^2 \times \frac{b_4}{b_3}), \quad k = 1, 2, 3. \quad (6.2.155)$$

Consequently, the Casimir-Santilli isoinvariant (6.2.121b) assumes the explicit form

$$\begin{aligned} \hat{P} \hat{\times} \hat{P} \hat{\times} |\hat{\psi}\rangle &= \hat{G}^{\mu\nu} \hat{\times} \hat{P}_\mu \hat{\times} \hat{P}_\nu \hat{\times} |\hat{\psi}\rangle = \\ &= \hat{\eta}^{\mu\nu} \times \hat{P}_\mu \times \hat{T} \times \hat{P}_\nu \times \hat{T} \times |\hat{\psi}\rangle = \\ &= (m_e^2 \times \hat{\gamma}^2 \times c_o^2 \times \frac{b_4^2}{b_3^2} \times (v_k \times b_k^2 \times v_k) - m_e^2 \times \hat{\gamma}^2 \times c_o^4 \times b_4^2) \times |\hat{\psi}\rangle = \\ &= m_e^2 \times c_o^4 \times \frac{b_4^4}{b_3^4} \times \hat{\gamma}^2 \times (\hat{\beta}^2 - 1) \times |\hat{\psi}\rangle = \\ &= -m_e^2 \times c_o^4 \times \frac{b_4^4}{b_3^4} \times |\hat{\psi}\rangle = -m_e^2 \times V_{max}^4 \times |\hat{\psi}\rangle, \quad (6.2.156) \end{aligned}$$

from which we obtain the *isorenormalization of the rest energy*

$$\begin{aligned} E_e = m_e \times c_o^2 \rightarrow E_{\hat{e}} &= m_e \times c_o^2 \times \frac{b_4^2}{b_3^2} = \\ &= m_e \times c_o \times \frac{n_3^2}{n_4^2} = m_e \times V_{max}^2, \quad (6.2.157) \end{aligned}$$

that resolved the ambiguities indicated earlier.

it is easy to expect, in general, similar mutations / isorenormalizations of *all* intrinsic characteristics of the electron. This illustrates a main prediction

of hadronic mechanics according to which strong interactions alter all intrinsic characteristics of particles in a hadronic bound state as well as in deep inelastic scatterings of hadrons. This prediction is impossible for quantum mechanics, trivially, because strong interactions are entirely represented with a Hamiltonian.

Among these predictions, it is worth recalling [96] that light emitted in the interior of the neutron structure reaches the outside *blueshifted*, namely, with an increase of its frequency according to Isoaxiom IV via a mechanism based on the absorption of energy from the medium itself.

The fact that the rest energy of the neutron is constant establishes the impossibility for light to be created inside an isolated neutron. In turn, this confirms the impossibility of assuming the speed of light as the basic invariant for the neutron structure.

Note that no mutation of the Doppler's law is possible for light in water due to its homogeneous and isotropic character.

The isodualities of the results of this section for the antineutron are left as a useful exercise for the reader interested in new scientific vistas.

6.2.8.H Isorenormalization of Electric and Magnetic Moments

Another, well known, important role of Dirac's equation is the characterization of the electric and magnetic moments. The next advance of Ref. [96], Eqs. (6.5), page 190, was the repetition of the characterization (see, e.g., Ref. [115]), this time for isoequation (6.2.143), resulting in the *isoprenormalized electric and magnetic moments*,

$$\hat{\epsilon}_{\hat{e}} = \epsilon_e \times \frac{b_3}{b_4}, \quad \hat{\mu}_{\hat{e}} = \mu_e \times \frac{b_3}{b_4}. \quad (6.2.158)$$

This derivation is also an instructive exercise for scholars interested in research intended as the pursuit of *new* knowledge.

6.2.8.I Representation of the Neutron spin.

Following all the preceding preparatory advances, Ref. [96] specialized the results to the isorelativistic representation of the simplified structure model of the neutron and antineutron

$$n = (p^+, \hat{e}^-)_{hm}, \quad (6.2.159a)$$

$$\bar{n} = (p^-, \hat{e}^+)_{hm}, \quad (6.2.159b)$$

where the proton p^+ and the antiproton p^- are not mutated, being about 2,000 times heavier than the electron and the positron.

As now familiar from the nonrelativistic study, Figure 6.23 in particular, a necessary condition for the consistency of models (6.2.159) is that the isoelectron and the isopositron have a null total angular momentum. In turn, this is possible

if and only if

$$|\hat{L}_3| = |\hat{S}_3|, \quad |\hat{L}^2| = |\hat{S}^2|. \quad (6.2.160)$$

By using isorealizationb (6.2.156), the above conditions require that

$$b_1^{-1} \times b_2^{-1} = \frac{1}{2} \times b_1 \times b_2, \quad (6.2.161a)$$

$$b_1^{-2} \times b_2^{-2} + b_2^{-2} \times b_3^{-2} + b_3^{-2} \times b_1^{-2} = \frac{1}{4} \times (b_1^2 \times b_2^2 + b_2^2 \times b_3^2 + b_3^2 \times b_1^2) \quad (6.2.161b)$$

which conditions admit the unique solution (Eq. (7.3), page 192, Ref. [96])

$$b_1 = b_2 = b_3 = b_s = \sqrt{2} = 1.415, \quad (6.2.162)$$

providing the numerical value of the space characteristic quantities of the proton and antiproton as predicted by the Dirac-Santilli isoequation.

It should be noted that the important geometric result here is the spherical shape of the proton, as expected from the fact that it is assumed not to be mutated. Also, such a shape is always defined up to scaling from the structure of the invariant (6.2.115). The actual charge radius of the neutron will be derived later on.

6.2.8.J Representation of the Neutron Rest Energy.

From Isoaxiom V and the preceding derivation (6.2.156) we have the isorenormalization of the rest energy

$$E_e = m_e \times c_o^2 = 0.511 \text{ MeV} \quad \rightarrow \quad E_{\hat{e}} = m_e \times c_o^2 \times \frac{b_4^2}{b_3^2} = E_n - E_p = 1.294 \text{ MeV}, \quad (6.2.163a)$$

$$\frac{b_4^2}{b_2^2} = 2.532, \quad \frac{b_4}{b_3} = 1.592, \quad (6.2.163b)$$

where m_e is the inertial mass of the electron, and the calculations apply for both the neutron and the antineutron.⁴⁶

The knowledge of the space characteristic quantity, Eqs. (6.2.162), then allows the computation of the numerical value of b_4

$$b_4^2 = \frac{1.293 \times 1.415}{0.511} = 3.580, \quad b_4 = 1.892, \quad (6.2.164)$$

⁴⁶Ref. [96] used the values $E_e = 0.5 \text{ MeV}$ and $E_n - E_p = 1.3 \text{ MeV}$, thus resulting in the numerical value $b_4/b_3 = 1.62$. The difference is noted to prevent possible claims of "mistake" ventured for political objectives far from serious science.

which value, for the approximations here assumed, is fully within the corresponding nonrelativistic expression, Eqs. (6.2.99d), as well as fully within the value obtained via the fit of experimental data on the Bose-Einstein correlation, Eqs. (6.1.112).

It should be noted that the comparison of values (6.2.164) and (6.1.112) indicates that the proton density (defined, again, as its rest energy divided by its volume) is *bigger* than the density of the Bose-Einstein fireball. This result, even though merely indicational at this stage of our knowledge, is correct because the fireball of the Bose-Einstein correlation is extremely elongated, thus resulting in a density lower than that of an individual proton.

6.2.8.K Representation of the Neutron Magnetic Moment.

As familiar from the analysis of the preceding section, the null value of the total angular momentum of the isoelectreon predicts that its intrinsic magnetic moment is, at best, very small. In fact, isoequation (6.2.158) permits the following numerical, exact and invariant representation of the anomalous magnetic moment of the neutron (Eqs. (7.4), page192, Ref. [96])

$$\mu_n = -1.9 \times \frac{|e|}{2 \times m_p \times c_o} = \mu_p + \hat{\mu}_{\hat{e},orb} + \hat{\mu}_{\hat{e},spin}, \quad (6.2.165a)$$

$$\mu_p = +2.7 \times \frac{|e|}{2 \times m_p \times c_o}, \quad (6.2.165c)$$

$$\mu_{e,intr} = +1.00 \times \frac{|e|}{2 \times m_e \times c_o} = 1\mu_B, \quad (6.2.165b)$$

$$\mu_{\hat{e},tot} = -4.6 \times \frac{|e|}{2 \times m_p \times m_o} = -2.4 \times 10^{-3} \times \frac{|e|}{2 \times m_e \times c_o}, \quad (6.2.165d)$$

$$\hat{\mu}_{\hat{e},intr} = +1 \times \frac{b_3}{b_4} \mu_B = \frac{1.415}{1.892} \mu_B = +0.747 \mu_B, \quad (6.2.165e)$$

$$\hat{\mu}_{\hat{e},orb} = -0.744 \mu_B. \quad (6.2.165f)$$

where we have used the configuration of Figure 6.23, and we should remember the change in direction of the magnetic moment caused by the change of the sign of the charge. The mutated electric moment of the neutron is ignored because very small in any case.

6.2.8.L Representation of the Neutron Meanlife and Charge Radius

As shown in well written treatments of the conventional Dirac equation (see, e.g., E. Corinaldesi and E. Strocchi [115], page 191 and following), the behavior of

the electron in the hydrogen atom is represented by a basic (scalar) contribution acting on each component of the wavefunction,

$$H^{(0)} \times \psi_1 = \left(\frac{p^2}{2 \times m_e} - e \times A_0 \right) \times \psi_1 = E \times \psi_1, \quad (6.2.166)$$

plus an infinite series of perturbative terms, the first one of the type

$$H^{(1)} \times \psi_1 = \left(-\frac{(p^2)^2}{8 \times m_e^3 \times c_o^2} - \frac{e}{2 \times m_e^2 \times c_o^2 \times r} \times \frac{dA_o}{dr} \times L * s - \frac{e \times \hbar^2}{8 \times m_e^2 \times c_o^2} \times \Delta A_o \right) \times \psi_1, \quad (6.2.167)$$

where A_0 is the fourth component of the electromagnetic potential A_μ originated by the external proton, $L * S$ is the usual scalar product, and the rest is well known.

The repetition of the same procedure for the the case of isoequation (6.2.143) characterized by isounit (6.2.114a) has the following main implications [96]:

1) The term $-e \times A_0$ in Eq. (6.2.166) is ignorable, as for the nonrelativistic case, due to the dramatically bigger contribution from the terms $\psi_e/\hat{\psi}_{\hat{e}}$.

2) All perturbative terms are consequently ignorable, as typical for hadronic mechanics due to its capability of turning conventional weakly convergent or divergent expansions into strongly convergent isotopic forms (see later on). 3) The resulting radial equation is then identical to the non relativistic expression (6.2.92) that we rewrite in the form including the meanlife and the charge radius

$$\left[\frac{1}{r^2} \left(\frac{d}{dr} r^2 \frac{d}{dr} \right) + \frac{\bar{m}_{\hat{e}}}{\hbar^2} \left(E_{hb} + V \times \frac{e^{-b \times r}}{1 - e^{-b \times r}} \right) \right] \times \hat{\psi}(r) = 0, \quad (6.2.168a)$$

$$\tau^{-1} = \lambda^2 \times |\hat{\psi}(0)|^2 \times \frac{\alpha^2 \times E_{hk}}{\pi \times \hbar}. \quad (6.2.168b)$$

$$R_n = b^{-1}, \quad (6.2.168c)$$

in which we have replaced the quantity m/ρ^2 unknown for Eqs. (6.2.92) with the known value $m_{\hat{e}} = 1.293 MeV/c_o^2$, the representation of parity being left to the interested reader. The repetition of the same procedure as that for the nonrelativistic case then yields the desired representation. In particular, the derivation confirms that Eq. (6.2.143) predicts one and only one energy level, that of the neutron, thus suppressing again the atomic spectrum of energy.

This complete the *numerically exact and time invariant relativistic representation via the Dirac-Santilli isoequation of all characteristics of the neutron as a hadronic bound state of a proton and an electron first achieved in Ref. [96], including the representation of: rest energy; meanlife; size; spin; charge; magnetic moment; and other characteristics; the spontaneous decay being treated in the subsequent section.*

6.2.8.M Dirac’s Generalization of Dirac’s Equation

Santilli pointed out in Ref. [96], page 191, the important historical occurrence according to which the first mutation of the total angular momentum of the electron from half-off-integer to integer values down to the value zero, was achieved by P. A. M. Dirac in papers [113,114]

Dirac’s papers remained vastly ignored by orthodox because not aligned with vested interest in old doctrines. By contrast, Santilli did study these papers in detail and presented their review in EHM, Volume II, Section 10.7, as well as in other works, including paper [96].

Due to the great historical significance of these studies by Dirac, it is important to outline here the main aspects. The reader should be aware that papers [113,114] are rather complex in conception and technical realization. Hence, by no means our brief review pays them justice, and their true understanding can only be gained by the study of the original works.

In Ref. [113] Dirac introduced the following equations called by Santilli *Dirac’s generalization of Dirac’s equation*

$$(a_\mu \times \partial_\mu + \beta) \times q \times \psi = 0, \tag{6.2.169a}$$

$$q = \text{Column } (q_1, p_1; q_2, p_2), \quad \psi = \text{Column } (\psi_{1+}, \psi_{1-}; \psi_{2+}, \psi_{2-}). \tag{6.2.169b}$$

By assuminmg

$$a_4 = I_{4x4}, \tag{6.2.170}$$

Dirac’s a-matrices are characterized by the expression [113]

$$a_\mu \times \beta \times a_\nu + a_\nu \times \beta \times a_\mu = 2 \times \beta \times \eta_{\mu\nu}, \tag{6.2.171}$$

where $\eta_{\mu\nu}$ is the conventional Minkowski metric.

On the basis of the above structure, Dirac reaches the following realization of the *a-* and *β-*matrices

$$\beta = \begin{pmatrix} 0 & 0 & 1 & 0 \\ 0 & 0 & 0 & 1 \\ -1 & 0 & 0 & 0 \\ 0 & -1 & 0 & 0 \end{pmatrix}, \quad a_1 = i \times \begin{pmatrix} 0 & 0 & -1 & 0 \\ 0 & 0 & 0 & 1 \\ -1 & 0 & 0 & 0 \\ 0 & 1 & 0 & 0 \end{pmatrix}, \tag{6.2.172a}$$

$$a_3 = \begin{pmatrix} 0 & 0 & 0 & 1 \\ 0 & 0 & 1 & 0 \\ 0 & 1 & 0 & 0 \\ 1 & 0 & 0 & 0 \end{pmatrix}, \quad a_3 = i \times \begin{pmatrix} 1 & 0 & 0 & 0 \\ 0 & 1 & 0 & 0 \\ 0 & 0 & -1 & 0 \\ 0 & 0 & 0 & -1 \end{pmatrix}. \tag{6.2.172b}$$

The angular momentum / spin is characterized by

$$S_{ij} = -(a_i \times \beta \times a_j - a_j \times \beta \times a_i) \times \frac{q \times q^t}{8}, \tag{6.2.173}$$

where t stands for transposed, and possesses the eigenvalues

$$\begin{aligned} S^2 &= S_{12}^2 + S_{23}^2 + S_{31}^2 = \\ &= \frac{1}{8} \times (q_1^2 + p_1^2 + q_2^2 + p_2^2) = J \times (J + 1), \end{aligned} \quad (6.2.174a)$$

$$J = \frac{1}{4} \times (q_1 + p_1 + q_2 + p_2) - \frac{1}{2} = \frac{1}{2} \times (n + n'), \quad (6.2.174b)$$

$$n, n' = 0, 1, 2, 3, \dots \quad (6.2.174c)$$

thus admitting the value $J = 0$ for the ground state.

Dirac introduced the above theory in paper [113] for a study of two coupled oscillators with quantum numbers q_k, p_k , $k = 1, 2$, and then continued the analysis in paper [114]. In the author's view, papers [113,114] are, by far, the most interesting papers ever written on oscillators.

The historical aspect particularly significant for hadronic mechanics is that, without his knowledge, *Dirac's generalization of Dirac's equation has an irreducible isotopic structure with isotopic element*

$$\hat{T} = \beta, \quad (6.2.175)$$

where irreducibility is referred to the property that papers [113,114] become inconsistent unless *entirely* elaborated with respect to the isoproducts of the type

$$A \hat{\times} B = A \times \hat{T} \times B. \quad (6.2.176)$$

In fact, Eq. (6.2.169a) can be identically written in the formalist of the Dirac-Santilli isoequation (6.2.143) according to the expressions

$$(a_\mu \times \partial_\mu + \beta) \times q \times \psi \equiv (\hat{\eta}^{\mu\nu} \times a_\mu \times \hat{T} \times p_\mu + 1) \times \hat{T} \times \hat{\psi} = 0, \quad (6.2.177a)$$

$$\hat{T} = \beta, \quad \hat{I} = \beta^{-1}, \quad \hat{\psi} = q \times \psi, \quad (6.2.177b)$$

$$p_\mu \hat{\times} \hat{\psi} = \hat{p}_\mu \times \hat{T} \times \hat{\psi} = -i \hat{\times} \hat{\partial}_\mu \hat{\psi} = -i \times \hat{I} \times \partial_\mu \psi, \quad (6.2.177c)$$

thus acquiring the full isotopic structure while preserving all results.

The irreducible nature of the above reformulation is established by the isoanticommutators of the a -matrices that can *only* be isotopic, i.e. of the type

$$\begin{aligned} \{a_\mu, a_\nu\} &= a_\mu \hat{\times} a_\nu + a_\nu \hat{\times} a_\mu = \\ &= a_\mu \times \hat{T} \times a_\nu + a_\nu \times \hat{T} \times a_\mu = a_\mu \times \beta \times a_\nu + a_\nu \times \beta \times a_\mu = 2 \times \hat{\eta}_{\mu\nu}. \end{aligned} \quad (6.2.178)$$

The above property illustrates the reason for the name "Dirac-Santilli isoequation" suggested for structure (6.2.143) and (6.2.177) by various authors.

The necessity of the correct isotopic reformulation should be kept in mind. It is easy to prove that Dirac's original formulation is *noncanonical* at the classical level and *nonunitary* at the operator level, thus activating the now familiar inconsistencies theorems. By contrast, the isotopic reformulation reconstructs canonicity and unitarity on isospaces over isofields, thus avoiding the inconsistency theorems.

It is also interesting to note the differences between Eqs. (6.2.143) and (6.2.177a) in the representation of the total null value of the angular momentum of the electron when inside the proton. This aspect was first studied in EHM Volume II, page 498, and can be outlined as follows. The lifting of the total angular momentum

$$J_{qm} = S_{spin} + L_{orb} = \frac{1}{2} + n \rightarrow J_{hm} = 0, \quad (6.2.179)$$

is achieved by Eq. (6.2.143) via an isotopic lifting of the $O(3)$ and $SU(2)$ symmetries in such a way that

$$\hat{J}_{hm} = \hat{S}_{spin} + \hat{L}_{orb} \equiv 0. \quad (6.2.180)$$

However, the lifting occurs under a *non-null* value of the individual components,

$$|\hat{S}_3| = |\hat{L}_3| \neq 0, \quad (6.2.181a)$$

$$|\hat{S}^2| = |\hat{L}^2| \neq 0. \quad (6.2.181b)$$

By contrast, Dirac achieves a null value of the total angular momentum via *null* values of its components,

$$\hat{S}_{spin} \equiv \hat{L}_{orb} \equiv 0. \quad (6.2.182)$$

The latter property has deep implications, by providing additional evidence of the unique capabilities of Dirac's intuition. In fact, Santilli's solution (6.2.181) does indeed hold under the conditions it is presented, namely, that Rutherford's electron is constrained to *orbit* inside the proton along its spin (Figure 6.23). By contrast, Dirac's solution (6.2.182) holds when *Rutherford's electron is compressed all the way to the center of the proton*, since, in the latter conditions, the orbital and intrinsic angular momenta are superimpose, thus resulting in an individual null, value.

The reader should be aware that the implications of papers [113,114] are simply beyond our imagination. We limit ourselves to indicate only a few implications to prevent excessive novelty that is at times disturbing.⁴⁷

⁴⁷Santilli has personally experienced countless cases in which the presentation of basically novel ideas caused uncontrollable repulsions, at times with hysterical overtones, including prohibitions at the last

For structural consistency, Dirac's generalization of Dirac equation cannot be formulated on the conventional Minkowski space $M(x, \eta, R)$ and must be formulated on the Minkowski-Santilli isospace $\hat{M}(\hat{x}, \hat{\eta}, \hat{R})$, this time, with isometric

$$\hat{\eta} = \beta \times \eta = \begin{pmatrix} 0 & 0 & 1 & 0 \\ 0 & 0 & 0 & -1 \\ -1 & 0 & 0 & 0 \\ 0 & -1 & 0 & 0 \end{pmatrix}, \quad (6.2.183)$$

namely, *Dirac-Santilli isoequation (6.2.177) characterizes the first known nondiagonal realization of the spacetime isometric.*

Rather than being an innocuous occurrence, the implications are far reaching because the line element now reads

$$\begin{aligned} x^{\hat{2}} &= x^{\mu} \times (\beta_{\mu}^{\rho} \times \eta_{\rho\nu}) \times x^{\nu} = x^{\mu} \times \hat{\eta}_{\mu\nu} = \\ &= x^1 \times x^3 - x^2 \times x^4 - x^3 \times x^1 - x^2 \times x^4 = -2 \times x^2 \times x^4, \end{aligned} \quad (6.2.184)$$

namely, *Dirac-Santilli isoequation (6.2.177) mutates spacetime from the conventional four-dimensions down to two-dimensions.* Moreover, the space *appears* from the outside as being 4-dimensional, while intrinsically it is only 2-dimensional, thus illustrating again the "isobox" of Chapter 3.

At this point, scientific priests solely intent in preserving old knowledge will rush to abuse their illusory academic credibility by stating that the above result is pure philosophy or a mere mathematical curiosity. Since our scientific knowledge can only be qualified as being lilliputian, having the very short life of at most two hundred years, when possible civilizations in the universe may have millions of years of scientific evolution, ascientific posturing of the above type are certainly far from reality.

Recall that, according to clear experimental evidence, the electron is a "pure oscillation" of space, namely, a structure in which there is no oscillation of a "little mass" or anything else we define as "material." In fact, Schrödinger proved in 1935 (the year in which the author was born) that the variable " x " in the conventional Dirac equation for a *free* electron describes a pure oscillation, of course, of space

moment to deliver invited lectures when the novelty of the topic appeared from the abstract, and the like. This behavior by persons who are expected as being "researchers" is so abnormal to have motivated the harsh comments that *researchers who feel repulsion to novelty behave like a priest desecrating the altar or a rabbi desecrating the torah.* A person decides to become a priest to honor the altar. Similarly, a person decides to become a rabbi to honor the torah. Hence, when a person decides to become a "researcher," he/she must dedicate his/her life to the pursuit of "new" knowledge, rather than the vigil guardianship of old knowledge. Showing repulsion to the presentation of new knowledge is a violation of the very essence of research, let alone amoral and ascientific. The list of names qualifying as "scientific priests desecrating the scientific altar" would fill dozens of pages, but definitely the name of P. A. M. Dirac would not appear in that list!

as a universal substratum for all events visible to mankind (Sections 6.1.2 and 6.1.3).

Intriguingly, *Dirac-Santilli isoequation (6.2.177) establishes that, in the transition from motion in vacuum to total immersion within the hyperdense medium inside the proton, the electron performs the mutation from an oscillation in (3+1)-dimension, to one in (1+1) dimension, namely, the electron is indeed reduced to a dimensionless point in space and time.*

In turn, the above result has its own far reaching implications, such as the possible triggering of continuous creation of matter in the universe studied in the next section, at which point it appears prudent to terminate the presentation of novelties because it may be disturbing to some (but not all!) physicists, as indicated above.

6.2.8.N Dirac-Santilli Genotopic and Hyperstructural Equations

The preceding studies have been conducted by assuming the neutron as isolated from the rest of the universe, thus resulting in conventional total conservation laws that required the isotopic branch of hadronic mechanics.

However, these are ideal conditions generally not verified in reality, since the neutron is generally a member of a nuclear process, such as the synthesis of the deuteron. The latter, by conception, is irreversible, in which case the isotopic branch of hadronic mechanics does not apply, requiring the broader genotopic branch (Chapter 4). In turn, this requires a broadening of the Dirac-Santilli isoequation (6.2.143) into a structurally irreversible form.

Under the assumption of a knowledge of Chapter 4, the latter objectives can be achieved via the selection of two different, yet conjugated units for motion forward and backward in time and related genoproducts,

$$\hat{I}^> = (\hat{I})^\dagger, \quad \hat{I}^> = 1/\hat{T}^>, \quad \hat{I}^< = \hat{T}, \quad (6.2.185a)$$

$$A > B = A \times \hat{T}^> \times B, \quad A < B = A \times \hat{I}^< \times B, \quad (6.2.185b)$$

the forward and backward geometrics

$$\hat{G}^> = \hat{\eta}^> \times \hat{I}^>, \quad \hat{G}^< = \hat{I}^< \times \hat{\eta}, \quad (6.2.186a)$$

$$\hat{\eta}^> = \hat{T}^> \times \eta, \quad \hat{\eta}^< = \hat{T} \times \eta, \quad (6.2.187b)$$

and remaining genomathematics herein assumed.

The *Dirac-Santilli forward genoequation* can then be written

$$\begin{aligned} & (\hat{G}^{>\mu\nu} > \hat{\Gamma}_\mu^{>} > \hat{P}_\nu^{>} + \hat{i}^> > \bar{m}_e^{>}) > |\hat{\psi}^> > = \\ & = (\hat{\eta}^{>\mu\nu} \times \hat{\gamma}_\mu^{>} \times \hat{P}_\nu^{>} + i \times \bar{m}_e^{>}) \times \hat{T}^> \times |\hat{\psi}^> > = 0. \end{aligned} \quad (6.2.188a)$$

$$(\hat{\gamma}_\mu^{>}; \hat{\gamma}_\nu^{>}) = \hat{\gamma}_\mu^{<} < \hat{\gamma}_\nu^{>} > \hat{\gamma}_\mu^{>} = 2 \times \hat{\eta}_{m\mu\nu}^{>}, \quad (6.2.188b)$$

$$\hat{P}_\mu^> |\hat{\psi}^> = -i \times \hat{I}_\mu^{>\rho} \times \partial_\rho |\hat{\psi}^>, \tag{6.2.188c}$$

with conjugate equations for the backward form.

Note that the *forward genogamma matrices* are characterized by bracket of "Jordan-admissible type." Note also that irreversibility is embedded in the most primitive possible form, in the genounits as well as in the geometrics. Note finally that geometrics are generally nondiagonal (Chapter 4).

The *Dirac-Santilli forward and backward hyperequations* are given by the preceding ones when the isounits are assumed as being nonhermitean as well as multivalued (Chapter 5).

6.2.8.O The Meeting between Dirac and Santilli

As a personal note, it may be of some value to recall that, prior to Dirac's death (occurred on October 20, 1984), Santilli had a short meeting with Dirac during a scientific conference in Florida, where Dirac had retired, during which meeting the main elements of this section were discussed. Santilli first approached Dirac by indicating interest in his papers [113,114], at which indication Dirac had one of his rare moments of visible pleasure, perhaps because extremely few physicists had been interested in the same papers.

After qualifying himself as being capable of understanding the papers (Santilli being a former member of the Department of Mathematics of Harvard University under DOE support), Santilli indicate to Dirac the extremely deep mathematical and physical implications of his work, including the surpassing of the mathematics used in the 20-th century physics, as well as the (at that time) potential representation of the synthesis of the neutron inside a star as originally conceived by Rutherford.

Santilli was aware that, in his last years, Dirac had been the victim of abuses by scientific gangsters in an illusory posture of academic power, who opposed and dubbed his late research as being "fringe science." This dubbing originated from Dirac's increasing opposition to quantum field theory due to its divergencies, thus implicitly opposing quark theologies. The highlight of the meeting occurred when Dirac instantly understood, following very few words, that the isotopies eliminate divergencies, at which point Dirac rose from his chair to sit down again and enter into a kind of "scientific trance," being clearly immerse in very deep thinking.⁴⁸

⁴⁸Isounit (6.2.114) verifies the properties

$$|\hat{I}_n| \gg 1, \quad |\hat{T}_n| \ll 1. \tag{a}$$

Consequently, any given *divergent* perturbative series,

$$\begin{aligned} A(w) &= A(0) + w \times [A, H]/! + w^2 \times [[A, H], H]/2! + \dots \rightarrow \infty, \\ [A, H] &= A \times H - H \times A, \end{aligned} \tag{b}$$

is turned into the strongly convergent series

$$A(w) = A(0) + w \times [A;H]/! + w^2 \times [[A;H];H]/2! + \dots \rightarrow N < \infty,$$

Following a minute or so of silence, Dirac asked Santilli: "How do you manage this type of research?" at which question Santilli honestly replied "amidst huge oppositions." In fact, Santilli had just been terminated at Harvard University despite the availability of large DOE funds. In particular, Santilli met Dirac precisely while writing the book *Ethical Probe of Einstein Followers in the USA: An Insider's View* [89] and its three volumes of documentation [90] (which books were indeed published the month and year of Dirac's death).

After an additional minute of silence, typical of his taciturn character, yet showing a deep mental activity, Dirac told Santilli something to the effect that he would help, and requested papers in the field. On his way back to the *Institute for basic Research* in Cambridge, MA, Santilli did mail to Dirac representative papers on hadronic mechanics via his address at Florida State University in Tallahassee. Unfortunately, Dirac's health deteriorated thereafter due to late age (or perhaps Santilli's papers were never released to him by FSU?), and Santilli never heard from Dirac again.

What a pity! There is no doubt that, had Dirac lived, or had Santilli visited Dirac earlier, the history of hadronic mathematics and mechanics would have been dramatically different because physical research advances on grounds of perceived relevance, and never on sole grounds of scientific content. Hence, had Dirac been able to release one single statement of interest on isomathematics and related topics, the popularity of hadronic mechanics would have been consequentially instantaneous and widespread.⁴⁹

$$[A, H] = A \times \hat{T} \times H - H \times \hat{T} \times A, \quad (b)$$

under the condition (verified for the Dirac-Santilli isoequation) that $|\hat{T}| \ll w$. This is the property instantly understood by Dirac and so evident in any case. Yet, the property has been another reason for opposing, obstructing and jeopardizing the construction of hadronic mechanics by world wide organized interests, with documented prohibition since 1983 (sic) without credible technical arguments to publish papers in the American, British, French, Swedish and other Physical Societies, prohibition to present papers in various international conferences, prohibition by major particle physics laboratories to consider proposals for truly basic experiments, etc.

The political roots of the obstructions are given by the fact that *hadronic mechanics permits a convergent perturbation theory for strong interactions*, let alone the removal of the divergencies, a feature well known to opposing interests. The point is that such a property would relegate Quantum ChromoDynamics (QCD) to pure mathematical theology, thus wiping out large public funds in the field. As indicated above, scientific gangsters dubbed Dirac's last studies as being "fringe science" because he was trying to remove the divergencies in QCD.

⁴⁹The understanding of the meeting between Santilli and Dirac requires the knowledge that it occurred while Santilli was the victim of the organized scientific crimes perpetrated by Sidney Coleman, Steven Weinberg and Sheldon Glashow at Harvard University denounced in Footnote 1 of this volume.

6.2.9 The Etherino Hypothesis

6.2.10 The Etherino Hypothesis on the Neutron Synthesis

6.2.10.A The Missing Energy in the Neutron Synthesis

By no means, the advances presented in the preceding sections resolve all basic problems in the structure of the neutron. In fact, we remain, among others, with the basic problem of identifying the *the origin of the energy 0.782 MeV missing in the reaction*

$$p^+ + e^- \rightarrow (p^+, \hat{e}^-)_{hm} = n, \quad (6.2.189a)$$

$$E_n - (E_p + E_e) = 939.565 - (938.272 + 0.511) \text{ MeV} = 0.782 \text{ MeV}. \quad (6.2.189b)$$

with the understanding, as indicated earlier, that the reaction

$$p^+ + \bar{\nu} + e^- \rightarrow (p^+, \hat{e}^-)_{hm} = n, \quad (6.2.190)$$

has no scientific sense because the missing energy is it positive, while $\bar{\nu}$ carries a *negative* energy, being an antiparticle. Additionally, the cross section between antineutrinos and protons or positron is essentially null. Hence, in the event predictable manipulations may turn the energy of an antiparticle into a positive value (something quite possible in a field in which science is conducted via abuses of academic power rather than admission of scientific veritas), said energy cannot possibly be delivered to the proton and/or to the electron.

Note that

6.2.10.B Possible Origins of the Missing Energy in the Neutron Synthesis

The above basic question was identified and studied by Santilli in paper [97], resulting in the following possible alternatives:

HYPOTHESIS 6.2.9.I: The 0.782 MeV missing in the synthesis of the neutron originate from its environment, such as that in the interior of stars.

Despite its seemingly plausible and rational character, the above hypothesis still remains with basic unsolved aspects. In fact, at the extreme pressures in the interior of stars, *the proton and the electron are essentially at rest at the time of the neutron synthesis.* Hence, Hypothesis I still remains with the unidentified mechanism of transferring the missing energy from the environment to the proton and/or the electron. Vague nomenclatures, such as "via the temperature," are indeed acceptable as academic parlance, but they are not adequate for the quantitative objectives of these volumes.

Independently from the above, the probability of the synthesis of the neutron is essentially null when the proton and the electron have the (relative) missing

energy of 0.782 MeV because, as indicated in Section 6.2.3, in that case their cross section becomes very small. This occurrence increases the difficulties for the transfer of energy from the environment to the proton or the electron and should not be surprising to serious scholars because it is written in history that basically new problems require basically new vistas.

In addition to the above, Hypothesis I is simply disconcerting for the author because it implies the *conception of stars as astrophysical bodies with internal mechanisms decreasing the energy in time*, while stars are one of the most majestic sources of energy in the universe. To see the differences between orthodox thinking and physical reality, physicists are suggested to multiply 0.782 MeV by the number of neutrons synthesized in a star every second, resulting in a *temperature loss* (in the sense that the heat energy is no longer usable because transferred to the neutrons) of the order of

$$E_{loss}^{star}/sec = 0.782 \times 10^{25} \text{ MeV}/sec. \quad (6.2.191)$$

Physicists should then verify that nuclear syntheses do overcome the above loss in such a way to result in a positive energy output. The above occurrences led Santilli to formulate the following alternative [97]

HYPOTHESIS 6.2.9.II: The 0.782 MeV missing in the synthesis of the neutron originate from the ether (aether) conceived as a universal substratum for all visible events in the universe with a very high energy density.

Needless to say, the latter hypothesis creates *more* problems than the first, as typically the case for basic advance. Yet, the serious study of unsolved basic issues requires serious scientific democracy, that is, the equal treatment of *all* possibilities, and then the selection of the correct one, after exhausting all avenues. Our interest here is merely that of "initiating" studies on the latter hypothesis, with the understanding (indicated in Section 6.1.3) that, due to their dimensions and potential outcome, the study of the ether may well require the entire third millennium.

To begin, Hypothesis II was formulated by Santilli [97] to initiate quantitative studies of the old hypothesis of *continuous creation of matter in the universe*, that has been voiced repeatedly during the 20-th century. Hence, paper [97] pointed out, apparently for the first time, that *the best possible mechanism for continuous creation in the universe is precisely the synthesis of neutrons inside stars*, via the assumption that the missing energy originates from the ether conceived as a universal medium with an extremely large energy density.

Rather than being farfetched, the hypothesis is supported by predictably insufficient, yet significant evidence, such as the fact that stars initiate their lives as being solely composed of hydrogen atoms that miss the energy needed for the

first and most fundamental nuclear synthesis, that of the neutron, after which all conventional nuclear syntheses follow.

Additionally, explicit calculations indicate that the immense energy needed for a supernova explosion, that are visible by the naked eye on Earth from very distant galaxies, simply cannot be explained via the sole use of conventional nuclear syntheses, particularly in view of the fact that supernova explosions occur at the *end of the life of stars*. This suggests again the possible existence of a mechanism extracting energy from the ether and transferring it into our spacetime.⁵⁰

To understand Hypothesis II, one should recall from Section 6.1.2, Ref. [1], that the notion of ether as a universal substratum appears as being necessary not only for the characterization and propagation of electromagnetic waves, but also for the characterization and propagation of all elementary particles and, therefore, for the very existence of all matter in the universe.

The need of a universal medium for the characterization and propagation of electromagnetic “waves” is so strong to require no study here, e.g., for waves with 1-m wavelength for which the reduction of waves to photons (for the evident hope of eliminating the ether as a medium to preserve Einsteinian theories) loses credibility.

The same notion of ether appears necessary also for the characterization and propagation of the electron, due to its structure as a “pure oscillation,” namely, an oscillation of one of the points of space in which there is no oscillation of a “little mass” as conventionally understood. Similar structures are expected for all other particles.

Once matter is *entirely* reduced to oscillations of a universal substratum [1], the transfer of energy from the substratum to our spacetime via the neutron synthesis and other events, become quite possible indeed.

It should be also recalled from Section 6.1.2. [1] that the above conception implies that, contrary to our sensory perception, *matter is totally empty, and space is totally full by a medium*, the former being mere excitations of the latter. This conception was submitted in paper [1] to illustrate the lack of existence of the “ethereal wind” [2] that delayed studies on the ether for at least one century.

In fact, under the above conception, motion of matter would merely require the transfer of the characteristic oscillations from given points of the ether to others. Mass is then characterized by the known equivalence of the energy of the characteristic oscillations, and inertia is the resistance provided by the ether against changes of motion [1].

⁵⁰The “explanation” of supernova explosions via gravitational collapse is more controversial than the nuclear one due to known catastrophic inconsistencies of gravitational theories on a curved space studied in Section 1.4 (see paper [13]). Prior to venturing credible judgments on the structure of the universe via Einstein’s gravitation, its catastrophic inconsistencies must be resolved first, not in equivocal academic corridors or via the usual silence, but via papers published in refereed journals.

6.2.10.C The Etherino Hypothesis

In order to conduct quantitative studies on the origin of the missing energy, Santilli [97] assumed that the synthesis of the neutron from protons and electrons occurs via the *absorption*, either from the environment inside stars or from the ether, of an "entity", called *etherino* (meaning in Italian "little ether") and represented with the symbol "*a*" (from the Latin aether), having mass 0, a minimum of 0.782 *MeV* energy, plus other possible features in the event necessary (see below). By unifying Hypotheses I and II, we reach in this way the following:

Etherino hypothesis on the neutron synthesis:

$$p^+ + a_n + e^- \rightarrow n, \quad (5.2.192)$$

where a_n denotes the *neutron etherino* (see below for other cases), and the energy 0.782 *MeV* is assumed as being "minimal" because of the presence of conventional "negative" binding energy due to the attractive Coulomb interactions between the proton and the electron at short distances, and other reasons.

The energy carried by the etherino is also assumed as being minimal in the event the neutrino exists as a physical particle, thus requiring the identification of the origin of its own energy. In fact, as now well known, the value 0.782 *MeV* is the minimal energy for the sole synthesis of the neutron.

It should be stressed that, in order to prevent the invention of additional hypothetical particles over an already excessive number of directly undetectable particles existing in contemporary physics, **the etherino is not a particle, but a mere mathematical symbol used to represent the transfer of the missing energy (and possibly other features) from the environment or the ether to the neutron.** The lack of characterization as a conventional physical particle will be made mathematically clear below.

Note that Hypothesis (6.2.191) was submitted [97] in lieu of (6.2.190) as a credible way to turn the negative energy of the antineutrino into the needed positive form, as well as as an attempt to resolve the excessive inconsistencies or insufficiencies of the neutrino hypothesis.

The synthesis of the antineutron in the interior of antimatter stars is evidently given by

$$p^- + \bar{a}_{\bar{n}} + e^+ \rightarrow \bar{n}. \quad (5.2.193)$$

where $\bar{a}_{\bar{n}}$ is the *antineutron antietherino*, namely an entity carrying negative energy as necessary for antimatter (Volume I). This would imply that the ether is constituted by a superposition of very large but equal densities of positive and negative energies existing in different yet coexisting spacetimes, a concept permitted by the isodual representation of antimatter with deep cosmological and epistemological implications since their total null value would avoid discontinuities at creation.

For the synthesis of the neutral pion we have the hypothesis

$$e^+ + a_{\pi^0} + e^- \rightarrow \pi^0, \quad (5.2.194)$$

where a_{π^0} is the π^0 -*etherino*, namely, an entity carrying mass, charge and spin 0 and minimal energy of 133.95 MeV transferred from the ether to our spacetime. Numerous similar additional forms of etherinos can be formulated depending on the hadron synthesis at hand.

6.2.10.D Representation of the Etherino via Hadronic Mechanics

It is evident that *hadronic mechanics* allows a quantitative representation of the etherino hypothesis and, more specifically, of the possible exchanges of energy between matter and the ether. In fact, the transfer of 0.782 MeV energy to the neutron is represented via: the isotopic lifting of the unit and Hilbert spaces

$$I > 0 \rightarrow \hat{I} = 1/\hat{T} > 0 \quad (6.2.195a)$$

$$\langle \psi | \times | \psi \rangle \times I \rightarrow \langle \hat{\psi} | \times \hat{T} \times | \hat{\psi} \rangle \times \hat{I}; \quad (6.2.195b)$$

the consequential isorenormalization of the rest energy and angular moments (see the preceding sections)

$$E_e = m \times c_o^2 \rightarrow E_{\hat{e}} = m_e \times c_o^2 \times \frac{b_4^2}{b_3^2}; \quad (6.2.196a)$$

$$S \rightarrow \hat{S}, \quad L \rightarrow \hat{L} \quad (6.2.196b)$$

and other isorenormalization processes.

The above representation also illustrates the purely mathematical character of the etherino as being a mere symbol to represent the *transfer* of a physical quantity to the neutron synthesis.

Once the missing energy has been transferred to the neutron constituents, evidently, it remains with the latter. and this illustrates the mechanism here considered of the continuous creation of matter in the universe.

6.2.11 Neutron Decay: Possible New Longitudinal Communications?

6.2.11.A Poincaré vs Poincaré-Santilli Symmetries

The most important implication of hadronic mechanics in the neutron synthesis (evident from the preceding two sections) is the lack of *necessary* spin 1/2 to be carried by the etherino, namely, only 0.782 MeV are needed for synthesis, since the neutron spin 1/2 is a consequence of constraining the electron to orbit within the proton with an angular momentum equal to its spin. This results in a null value of the total angular momentum of the mutated electron (isoelectron), and

the spin of the neutron coincides with that of the proton (Figure 6.23). A deeper understanding of this mechanism is now important for an initial study of the neutron decay.

At it is well known to experts, *Einstein special relativity prohibits the above representation of the neutron spin because it would require the breaking of its central pillar, the Poincaré symmetry*. Recall that the Poincaré symmetry was conceived for *Keplerian systems*, typically represented by our Solar systems, consisting of a *finite number of point-like, massive constituents without collisions in individually stable orbits around a heavier constituent, the Keplerian nucleus*.⁵¹

A crucial consequence is that represented via the familiar ten conservation laws of total quantities,

$$\frac{dX_i(t, r, p)}{dt} = \frac{\partial X_i}{\partial b^\mu} \times \frac{db^\mu}{dt} + \frac{\partial X_i}{\partial t} = 0, \quad (6.2.197)$$

where

$$X_1 = E_{tot} = H = T + V, \quad (6.2.198a)$$

$$(X_2, X_3, X_4) = \mathbf{P}_{Tot} = \Sigma_a \mathbf{p}_a, \quad (6.2.198b)$$

$$(X_5, X_6, X_7) = \mathbf{J}_{tot} = \Sigma_a \mathbf{r}_a \wedge \mathbf{p}_a, \quad (6.2.198c)$$

$$(X_8, X_9, X_{10}) = \mathbf{G}_{Tot} = \Sigma_a (m_a \times \mathbf{r}_a - t \times \mathbf{p}_a), \quad (6.2.198d)$$

$$i = 1, 2, 3, \dots, 10; \quad k = 1, 2, 3; \quad a = 1, 2, 3, \dots, N.$$

from which we have the necessary conservation, individually and separately, of the linear and angular momentum. Possible internal exchanges of linear momentum and angular momentum are prevented by the lack of collision.

There is no doubt that, as above conceived, the Poincaré symmetry is indeed exact for the above identified systems. However, the belief that Einstein's special relativity and its underlying Poincaré symmetry apply to all possible systems is sheer scientific corruption, particularly when proffered by experts with uncontrollable fanatic fervor for nonscientific aims.

In fact, the Poincaré symmetry is *inapplicable* for the neutron synthesis (rather than violated because not conceived for that) because:

1) The keplerian constituents must admit a point-like abstraction under which the neutron synthesis is impossible, e.g., because the electron would simply go through the proton without bonding;

2) The keplerian constituents must admit no collision, under which additional condition the neutron synthesis is also impossible;

⁵¹The lack of collision for the applicability of the Poincaré symmetry is carefully avoided in textbooks and Ph. D. courses because its admission, alone, would flair up the understanding of its limitations, with consequential unwanted search for suitable generalizations of Einsteinian doctrines.

3) The system must be time reversal invariant, namely, the time reversal event must be causal (as it is indeed the case for a Keplerian system), under which conditions the neutron synthesis is impossible because structurally irreversible and would violate the energy conservation in any case.

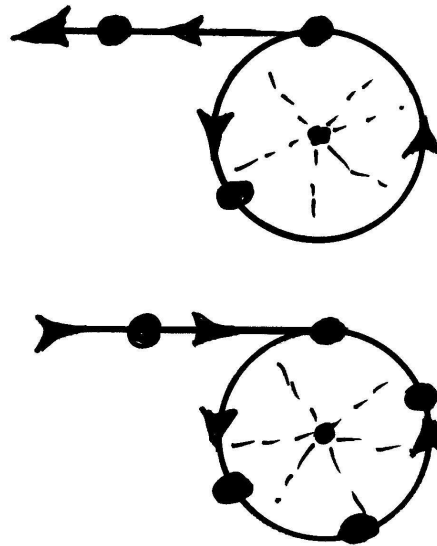

Figure 6.25. A schematic illustration of the inapplicability of Einstein's special relativity and its fundamental Poincaré symmetry for systems with constraints. The "sling shot" of this figure illustrates physical events impossible for special relativity and its Poincaré symmetry, but existing in the physical reality, such as the conversion of angular into linear momentum in the top view and the conjugate case of conversion of linear momentum into angular momentum in the lower view. When the physical reality of the neutron structure is admitted as being a constrained system, there is no need for the neutrino conjecture for both the neutron synthesis as well as for its decay. The understanding is that models without and with neutrinos do not necessarily exclude each other, the only scientific exclusion being that via unbiased experiments. The picture also illustrates the reason the author considers current "experimental results" in deep inelastic scattering as being "experimental beliefs." In fact, said results are claimed via the use of the conventional potential scattering theory under the notorious conditions of verifying Einsteinian doctrines and the Poincaré symmetry, thus (tacitly) excluding constrained conditions and exchanges of the type illustrated in this figure.

By comparison, the Poincaré-santilli isosymmetry:

- 1') Represents the constituents as extended, nonspherical and deformable;
- 2') Admits collisions between the constituents at mutual distances equal or smaller than their size; and

3') Can be extended to an irreversible formulation via the lifting of the isounit into a non-Hermitean form.

Additionally, the isosymmetry readily admits constraints on the conversion of linear into angular momentum and vice-versa (see Figure 6.25), such as the trivial constraint

$$P_k \equiv C \times \epsilon_{kij} r_i \wedge p_j. \quad (6.2.6.2.199a)$$

$$E_p \equiv E_L, \quad (6.2.199b)$$

where C is a dimensional constant that can be derived from the underlying basic conservation, that of the energy. More complex forms of constraints are left to interested colleagues.

At the limit, *the sole quantity with a certain conservation is the energy*, since all other quantities may admit one or another form of conversions among themselves and into energy. In fact, the kinetic energy carried by the linear momentum is the primitive physical quantity with ultimate conservation, since the linear momentum can transform itself into angular momentum and vice versa.

6.2.11.B Alternatives in Neutron Decay

Without doubt, *the spontaneous decay of the neutron constitutes strong evidence that the proton and the electron are its physical constituents, merely emitted via hadronic tunneling*, and we shall write

$$(p^+, \hat{e}^-)_{hm} \rightarrow (p^+ + e^- + ?)_{qm}, \quad (6.2.200)$$

where the question mark indicates the open issue of reconciling the l.h.s. treated with hadronic mechanics (hm), and the r.h.s, treated with conventional quantum mechanics (qm), the emitted particles being in vacuum.

It is also evident that the etherino hypothesis requires a reinspection of such a spontaneous decay. To conduct a true scientific analysis, rather than adopt a scientific religion, it is necessary to identify all plausible alternatives, and then reach a final selection via experiments. We reach in this way the following *three* possible alternatives [97]:

1. Neutron decay without etherino and antineutrino:

$$n = (p^+, \hat{e}^-)_{hm} = (p^+ + a_n + e^-)_{hm} \rightarrow (p^+ + e^-)_{qm}, \quad (6.2.201)$$

1. 2. Neutron decay with the emission of the etherino:

$$n = (p^+, \hat{e}^-)_{hm} = (p^+ + a_n + e^-)_{hm} \rightarrow (p^+ + e^- + a_n)_{qm}; \quad (6.2.202)$$

3. Neutron decay with the emission of the antineutrino:

$$n = (p^+, \hat{e}^-)_{hm} = (p^+ + a_n + e^-)_{hm} \rightarrow (p^+ + e^- + \bar{\nu})_{qm}. \quad (6.2.203)$$

Case 1 is fully allowed by hadronic mechanics via the transformation of the constrained angular momentum of the isoelectron into the linear momentum of the electron in vacuum as per Figure (6.2.25). This case supports the continuous creation of matter because, after having been transferred from the ether to the neutron, the originally missing energy of 0.782 MeV remain in our spacetime and are carried by the emitted particles..

Case 2 essentially implies that some or all of the originally missing energy of 0.782 MeV is returned to the ether as a universal medium. Note that this case does not necessarily imply the denial of of the continuous creation because, following its synthesis and acquisition of 0.782 MeV , the resulting neutrons generally belongs to stable nuclei.

Case 3 is very controversial and merely quoted here for completeness because the antineutrino is expected to carry *negative* energy, thus creating a number of fundamental open issues. Of course, believers in neutrinos could interchange them with antineutrinos "to fix things," but this would create a host of additional problems in the standard model.

Case 3 is primarily listed here to indicate that *the lack of existence of the neutrino for the neutron synthesis, by no means, implies that the neutrino does not exist for the neutron decay.* In different words, the neutron synthesis and its spontaneous decay are two basically different problems requiring independent treatment and. of course, separate experimental resolutions.

Needless to say, a selection between alternatives 1, 2, 3, is impossible on theoretical grounds alone, and can only be seriously achieved via experiments, such as those "requested" in the last appendix of this chapter. The problem is that the most fundamental and important a given experiment is, the bigger the organized interests against its consideration, let alone conduction.

6.2.11.C New Longitudinal Communications triggered by the Neutron?

As indicated in Section 6.1.3, when considered at interstellar distances, our current communications via electromagnetic waves can only be compared to pre-historical communications via smoke signals, due to the fact that the speed of light becomes excessively small for interstellar distances. Clearly, interstellar science will initiate the day in which quantitative research is initiated on possible new forms of communications admitting speeds millions of times bigger than that of light in vacuum. Clearly, such a scientific process can only initiate under the condition that it is beyond Einsteinian doctrines. Clearly, studies of this nature are expected to require centuries of trial and errors.

Once the problem is structured in the appropriate nonpolitical venue, systematic studies may reveal a varieties of possibilities, some of which may be already

under study experimentally, such as correlated spin effects, matter transmission, and others.

The possibility here indicated for the young mind of any age is that physical media of high rigidity, as the ether is expected to be, should indeed admit (at least) two forms of communications, the transversal ones already in use in electromagnetic communications (in which the oscillations are perpendicular to the direction of propagation), and a new, hitherto unknown communication of longitudinal character (in which the oscillations are along the direction of propagation).

Besides its intrinsic interest, the search for new communications is suggested by the possibility that *current experimental claims on "neutrino detection" are indeed real, and only in need for a more adequate interpretation.* Alternatively, we must stress that *the lack of existence of neutrinos does not necessarily invalidate available experimental data on neutrino experiments.*

The most fundamental synthesis in nature, that of the neutron, emerges again as fundamental for the above issues. In the event the missing energy of 0.782 MeV in the neutron synthesis does indeed originate from the ether, its transfer to the neutron should create a form of impulse in the ether itself and its propagation cannot possibly be transversal, thus leaving as sole possibility its longitudinal form. Speeds millions of times bigger than the speed of light in vacuum are then consequential.

Consequently, *it is possible that current experiments on "neutrino detection," rather than detecting the emission of the imaginary neutrino in our spacetime,*

$$p^+ e^- \rightarrow n + \nu, \quad (6.2.204)$$

detect instead a longitudinal impulse propagating through the ether, herein denoted ℓ . We reach in this way the following

Hypothesis of longitudinal impulses via the neutron synthesis:

$$p^+ e^- \rightarrow n + \ell. \quad (6.2.205)$$

besides potential contributions beyond our imagination at this writing, the latter alternative would render more plausible the claims of current neutrino experiments. In fact, they are currently based on the theological belief that massive particles, such as the neutrinos in their current conception, could traverse entire stars and galaxies without any collision, a belief clearly beyond any rational basis.

the traversing of entire stars and galaxies without collision is instead fully plausible for alternative (6.2.205) since, in the latter case alone, no massive entity propagates at all, the propagation being related to a longitudinal impulse through space.

In short, interstellar communications need a new Guglielmo Marconi capable of conceiving longitudinal or other forms of very fast communications, as well as capable of producing them and then detecting them at a distance.

6.2.12 Laboratory Synthesis of the Neutron from Protons and Electrons

6.2.12.A The Dominant Factor in the Neutron Synthesis: Ethical Decay in Physics

Addressing the problem of the laboratory synthesis of the neutron without the joint addressing of issues pertaining to scientific ethics and accountability, would be so hypocritical to be repugnant to the author.

The synthesis of the neutron is, by far, the most fundamental synthesis in nature because the synthesis of all matter beyond the hydrogen depends on the prior synthesis of the neutron. Additionally, the neutron is an inextinguishable reservoir of energy, since it is naturally unstable (when isolated and member of certain nuclei) and decays into the proton plus a highly energetic electron that can be easily trapped with a thin metal shield.

Hence, we have a societal duty to study the possible synthesis of the neutron (done in this section) and its stimulated decay (done in the next section). Moreover, the neutron synthesis and decay offer serious possibilities to reach in due time new forms of energies via the use of *light* (rather than heavy) nuclei, thus having a realistic chance of decreasing harmful radiations and waste, whose study is mandated by scientific ethics and accountability.

Despite these transparently relevant aspects, well known to experts to qualify as such, it has been impossible for the author in about thirty years of failed attempts to locate *any* laboratory *anywhere* on Earth willing to "consider," let alone conduct, laboratory tests on the synthesis of the neutron as it occurs in stars, from protons and electrons.

At this point it is necessary to recall that experiments have their own standard of value: the more fundamental is a test, the bigger is the priority for its conduction over manifestly lesser relevant tests. Hence, the systematic refusal of laboratories in the U.S.A., England, France, Germany, Russia, Sweden, Norway, China, Japan, and other countries to conduct tests on the synthesis of the neutron seals the existence of serious problems of scientific ethics and accountability in the contemporary physics community that must be addressed by anybody with a minimum care for society.

The reason for the impossibility of even "considering" the laboratory synthesis of the neutron is that such a synthesis is impossible for Einsteinian doctrines and quantum mechanics, as reviewed in the preceding sections. Hence, the mere "consideration" of the experiment would imply laboratory directors being the target of organized scientific crime on Einsteinian doctrines, resulting in academic

and family disruptions similar to those suffered by the author for three decades (see Footnote 1 of this Volume II and the other footnotes).

The first tests on the laboratory synthesis of the neutron was done in the 1960s by a collaboration headed by Don Carlo Borghi, an Italian priest-physicist of the University of Milano, and it is today known as the *Don Borghi experiment* [116,117]. The experiment was so opposed, disrupted and jeopardized by the organized scientific crime of the time in Italy that Don Borghi was forced to leave Italy and conduct the test in Brazil.

Following the release of the claim of having successfully achieved the laboratory synthesis of the neutron, the attacks on Don Borghi's experiments in Italy and elsewhere increased in time, thus showing their true character as the outcome of organized scientific crime. In fact, all dismissals and dubbings have been based on purely theoretical considerations without first repeating the test. Finally, said character is sealed by the fact that Don Borghi experiment is quite simple and inexpensive to repeat as shown in this section, thus voiding the objections of any credibility other than the opposition to undesired human knowledge.

Due to the failure by the world wide physics community to repeat Don Borghi's experiments for over thirty years, Santilli had no other choice that repeat the experiment himself [118,119], as reported below in this section. In so doing, Santilli became the victim of additional attacks, such as that of for promoting "fringe science" (Wikipedia) and similar dubbings, again, without the prior repetition and dismissal of the new measurements.

It should be stressed that, in the event the above organized opposition was indeed convinced that the neutron synthesis is impossible in laboratory, Don Borghi and Santilli should have been *encouraged*, rather than opposed, to conduct the test since they would have been negative. In any case, it is set in history that any experiment, even when negative, is beneficial to human knowledge. Hence, evidence accumulated over some thirty years identifies clearly and incontrovertibly the existence of a world wide organized scientific crime intent in suppressing undesired human knowledge, thus perpetrating a crime against mankind.

Any person with a minimum of dignity and care for human knowledge should admit that a condition of the above type cannot continue indefinitely without inflicting severe damages to society. Somebody, somehow, somewhere has to initiate the containment of the ethical decay. For this reason, Santilli has reached the following decisions:

- 1) Publicly denounce for scientific corruption any scientists who criticizes experimental *measurements* on pure grounds of *theoretical* conjectures. Needless to say, experiments must indeed be subjected to theoretical elaborations and discussions. However, the use of theoretical beliefs for the dismissal of new measurements just because they are not aligned with Einsteinian doctrines is a crime against society that, if we really care, must be openly denounced as such.



Figure 6.26. A view of the Italian priest-physicist Don Carlo Borghi, originally of the University of Milano, who dedicated his research life to theoretical and experimental studies on Rutherford's legacy, namely, to the study of the neutron as a bound state of a proton and an electron. It appears that Don Borghi had indeed a fulfilling religious life, but his studies on the neutron were opposed by the organized scientific crime in Italy of the 1960s to such an extent, he had to leave Italy and conduct experiment [116,117] in Brazil. The theoretical papers by Don Borghi and his associates on the neutron structure lack the advanced mathematical knowledge needed for a consistent quantitative study of the problem. As such, these theoretical studies are inconclusive and left for inspection to interested historians. However, no matter what its final interpretation will be, Don Borghi's test [116,117] deserves indeed the historical priority of being the first experiment on the laboratory synthesis of neutrons from protons and electrons.

2) Publicly denounce as scientific corruption all rejections for the publication of *experimental* papers on sole *theoretical* machinations, because measurements can only be scientifically dismissed via counter-measurements.

3) Promote legal proceedings and/or class actions for lack of scientific ethics, absence of accountability, misuse of public funds, and other changes, against

laboratories operating under public financial support in which basic experiments on open fundamental issues, such as those on the inapplicability of Einsteinian doctrines, are dismissed in favor of other experiments generally of dramatically bigger cost, yet of comparatively insignificant (at best) scientific relevance.

Following thirty years of documented experiences, the author's view is that the grip of the organized scientific crime on Einsteinian doctrines at laboratories such as SLAC, FERMILAB, CERN, SACLAY, RUTHERFORD, DESY, JINR and others is so strong, capillary and diversified that there is no hope for their participation in truly basic experiments until said laboratories are brought to court and the organized scientific crime currently in their control is unmasked. The author sincerely prays to be mistaken, but that requires serious basic experiments under serious ethical scrutiny.⁵²

6.2.12.B Don Borghi's Experiment on the Neutron Synthesis

The first experiment on the synthesis of neutrons from protons and electrons was conducted by Don Carlo Borghi and his associates C. Giori and A. Dall'Olio in the 1960s at the CEN Laboratories in Recife, Brazil [116,117].⁵³

Needless to say, Don Borghi's experiment is in need of independent reruns, either in its original form, or in one of several alternatives discussed in the next subsection. Nevertheless, Don Borghi's experiment constitutes the first historical test on Rutherford's conception of the neutron, and it is remarkable, not only because of the claimed results, but also because of its simplicity and low cost.

In essence, the experimentalists placed in the interior of a cylindrical metal chamber (called *klystron*) a hydrogen gas (at a fraction of 1 *bar* pressure) originated from the electrolytical separation of water, kept mostly ionized by an electric arc (with about 500 *V* and 10 *mA*) and traversed by microwaves (with 10^{10} s^{-1} frequency). Since protons and electrons are charged, they could not escape from the metal chamber, and remained trapped in its interior.

⁵²The reader in good faith should be aware that, according to intelligence gathered by an investigative firm hired by the International Committee on Scientific Ethics and Accountability (www.scientificethics.org), the organized scientific crime currently controlling physics laboratories is planning indeed the repetition of the tests [116-1179], but for the premeditated intent of dismissing the tests via manipulations of the type illustrated in Appendix 6A, and certainly not for scientific knowledge. This is the reason for the need of continuing the conduction of the tests outside said crime and irrespective of their claims. In the final analysis, scientific truth always emerges and the bigger is the opposition against tests [116-119], the bigger will be the condemnation by posterity. **It should be finally noted that, at this writing (January 19, 2008), Santilli is coordinating the repetition of tests [116-119] at a number of laboratories thanks to all necessary funds provided by the industrial applications of hadronic mechanics, although Santilli is prohibiting their disclosure at this time to prevent certain disruption by the organized scientific crime.**

⁵³The submission for publication [117] was done following Don Borghi's death by Santilli (without his name appearing in the paper), and publication occurred thanks to the support by N. Takybayev from Kazakhstan that is here acknowledged with most sincere gratitude.

In the cylindrical exterior of the chamber the experimentalists placed various materials suitable to be activated when exposed to a neutron flux (such as gold, silver and other substances). Following exposures of the order of weeks, the experimentalists reported nuclear transmutations due to a claimed neutron count (of up to 10^4 cps), apparently confirmed by beta emissions (evidently not present in the original material). For the next subsection, note that experiment [116,117] makes no claim of direct detection of neutrons, and only claims the detection of clear nuclear transmutations.

It is evident that, if confirmed, Don Borghi's experiment establishes Rutherford's conception of the neutron, as well as its treatment via hadronic mechanics, since the latter is the only mechanics permitting an exact and invariant representation of all characteristics of the neutron as a bound state of a proton and an electron.

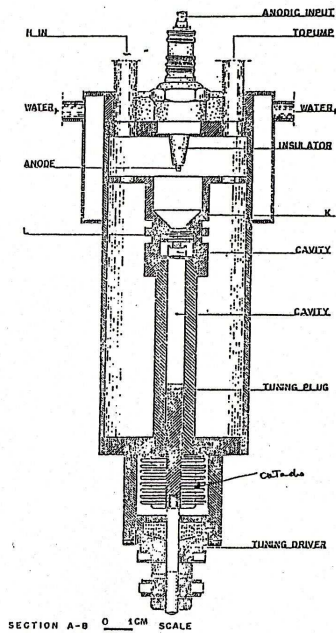

Element -	Net mass (gr)	Date -	Max net Activity ($\alpha/10^3$)
Dy (oxide)	2,580	13/02/70 06/08/70	83 107
Nb (oxide)	2,128	26/02/70 04/08/70	61 47
Er (oxide)	5,361	26/01/70 27/07/70	69 118
Sb (oxide)	2,688	18/02/70 24/07/70	51 97
In (metallic)	0,135	21/01/70	54
Ag (metallic)	2,130	12/02/70 16/06/70	51 17
Au (metallic)	0,960	23/02/70 10/07/70	10 27
Tl (metallic)	10,260	14/02/70	41

Figure 6.27. A view of the klystron used in tests [116,117] and one of the tables of results showing nuclear transmutations that can only occur via exposure to entities originating from the interior of the klystron, which entities have to be necessarily neutral and particle size (to pass through the metal wall of the klystron) and have strong interactions (to be absorbed by nuclei).

6.2.12.C Santilli's Experiment "toward" the Neutron Synthesis.

We now report test [118-119] conducted by R. M. Santilli on the synthesis of the neutron from protons and electrons, which tests were initiated in 2006 and completed with systematic repetition and reruns in 2007. As we shall see, *Santilli experiment [1118-119] confirms Don Borghi's experiment [116-117], although in a rather suprising way identified below.* Needless to say, Santilli makes no claim of final confirmation. As a matter of fact, experimental studies in the synthesis of the neutron are at their beginning and so much remains to be done. Also, in view of this initial character, any expectation of full maturity or criticism for insufficiencies of measurements [118-119] without their rerun, shall be denounced as scientific corruption since the fields needs measurements rather than theologies.

A serious study of Don Borghi's experiment requires: 1) The identification of the process creating the neutral, strongly interacting entities; 2) The identification of the entities themselves; and 3) The identification of the nuclear reactions they induce.

As reviewed above, tests [116-117] had two different processes in the interior of the klystron, the electric arc and the microwave. According to the original presentations [116], it *appears* that the experimentalists expected the neutral entities to originate from resonating effects caused by microwaves, and assumed the electric arc as essentially having the role of maintaining the hydrogen gas partially ionized.

Santilli conceived experiment [118] as being solely based on the use of an electric arc within a cold (i.e., at atmospheric temperature) hydrogen gas without any use of microwave at all, for the specific purpose of initiating systematic studies on the mechanism creating the neutral entities. The expectation was that, in the absence of any detection of neutral entities via the sole use of the electric arc, the addition of high frequency microwaves was expected to be necessary.

A main result of experiment [118-119] is that *the sole use of electric arcs within a hydrogen gas produces entities causing nuclear transmutations that confirm Don Borghi's experiment [116-117].* The use of high frequency microwaves has not been studied during these measurements [118,119]. Ref. [118] contains a summary of the measurements, while Ref. [119] contains various details, including copies of the print outs of some of the numerous scans.

All tests here reported were conducted at the laboratory of the Institute for Basic Research (IBR) in Palm Harbor, Florida, with the participation of the IBR technicians Terry Allen, John T. Judy, Michael Rodriguez, Jim Alban and Ray Jones, whose professional assistance has been invaluable for the conduction of tests [118,119] as well as for their detailed record and documentation.

Radiation counts were done via:

- 1) A photon-neutron detector model *PM1703GN* manufactured by Polimaster, Inc., with sonic and vibration alarms as well as memory for printouts, with the photon channel activated by CsI and the neutron channel activated by LiI;
- 2) A photon-neutron detector SAM 935 manufactured by Berkeley Nucleonics, Inc., with the photon channel activated by NaI and the neutron channel activated by $He-3$ also equipped with sonic alarm and memory for printouts of all counts;
- 3) A BF^3 activated neutron detector model 12-4 manufactured by Ludlum Measurements, Inc., without counts memory for printouts;
- 4) An alpha, beta, gamma and X-ray detector model 907-palmRAD manufactured by Berkeley Nucleonics, Inc.; and
- 5) Samples of commercially available materials suitable for activation.

Electric arcs were powered by welders manufactured by Miller Electric, Inc., including a Syncrowave 300, a Dynasty 200, and a Dynasty 700 capable of delivering an arc in DC or AC mode, the latter having frequencies variable from 20 to 400 Hz.

The following three different klystrons were manufactured, tested and used for the measurements (see [119] for pictures):

Klystron I: A sealed cylindrical klystron of about 6" outside diameter (OD) and 12" height made of commercially available, transparent, PolyVinyl Chloride (PVC) housing along its symmetry axis a pair of tungsten electrodes of 0.250" *OD* and 1" length fastened to the tip of 0.250" *OD* conducting rods protruding through seals out of the top and bottom of the klystron for electrical connections. The electrodes gap was controllable by sliding the top conducting rod through the seal of the flange. The PVC was selected to be transparent so as to allow a visual detection of the arc.

Klystron II: A rectangular, transparent, PVC klystron 3" \times 3" \times 6" filled up with commercial grade hydrogen at atmospheric pressure and temperature traversed by a 2" long electric arc powered by a standard Whimshurst electrostatic generator.

Klystron III: A cylindrical metal klystron fabricated in schedule 80 carbon steel pipe with 12" *OD*, 0.5" wall thickness, 24" length and 3" thick end flanges capable of withstanding hydrogen pressure up to 500 psi with the internal arc between thoriated tungsten electrodes controlled by outside mechanisms.

A first series of measurements were initiated with Klystron I on July 28, 2006, at 2 p.m. Following flushing of air, the klystron was filled up with commercial grade hydrogen at 25 *psi* pressure. We first used detector *PM1703GN* to verify that the background radiations was solely consisting of photon counts of 5 – 7 $\mu R/h$ without any neutron count; we delivered a DC electric arc at 27 *V* and 30 *A* (namely with power much bigger than that of the arc used in Don



Figure 6.28. A picture of Klystron I and of detector SAM 935. Note the similarity with the klystron used in tests [116,117], but also the primary differences being given by the use of metal walls for tests [116,117], and transparent polycarbonate walls for tests [118,119]. The latter were selected so as to permit the visual identification of the creation of an interior electric arc with a gap between the electrodes, the latter being necessary to assure the creation of a discharge through the hydrogen gas.

Borghini's tests [116,117]), at about 0.125" gap for about 3 s; we waited for one hour until the electrodes had cooled down; and then placed detector *PM1703GN* against the PVC cylinder. This resulted in the detection of photons at the rate of 10 – 15 $\mu R/h$ expected from the residual excitation of the tips of the electrodes, but no neutron count at all.

However, about three hours following the test, detector *PM1703GN* entered into sonic and vibration alarms, specifically, for neutron detections off the instrument maximum of 99 *cps* at about 5' distance from the klystron while no anomalous photon emission was measured. The detector was moved outside the laboratory and the neutron counts returned to zero. The detector was then returned to the laboratory and we were surprised to see it entering again into sonic and vibrational alarms at about 5' away from the arc chamber with the neutron count off scale without appreciable detection of photons, at which point the laboratory was evacuated for safety. After waiting for 30 *m* (double neutron's lifetime), we were surprised to see detector *PM1703GN* go off scale again in neutron counts at a distance of 10' from the experimental set up, and the laboratory was closed for the day.

Inspection of the laboratory the following morning indicated no neutron detection in the general area, but detector *PM1703GN* showed clear neutron counts when placed next to the PVC wall. The same detections persisted for two subsequent days until the hydrogen was flushed out of the chamber.

The test was repeated the afternoon of August 4, 2006, with the welder operating in AC mode at 30 V and 30 A plus a transformer that allowed to deliver an arc with 700 V and 1.2 A for 5 s with a gap of about 0.375". We waited again until the incandescence of the tips was extinguished and placed detector *PM1703GN* near the cylindrical PVC wall, resulting in sonic and vibrational alarms much sooner and definitely bigger than those of the first test with DC arc requiring, again, the evacuation of the laboratory.

Most significantly, detector *PM1703GN* would repeatedly go into sonic and vibrational photon alarms when placed against the cylindrical PVC wall up to three weeks following the last activation of the arc, namely, after a period of time excluding residual atomic excitations, thus confirming nuclear reactions.

During the preceding tests detector SAM 935 was used for a verification of the readings of *PM1703GN* with rather puzzling results. In fact, detector SAM 935 did show clear detections of apparent neutrons via counts clearly above the background of 0.10 cps, but such counts had no comparison with the continuous neutron alarms of detector *PM1703GN* (see the figures and the scans in [119]).

The settlement of this ambiguity delayed the completion of the measurements for a number of months due to the need for the proper selection and reception of a third detector. Following various theoretical studies, we selected and secured the BF^3 activated detector 12-4, namely, a neutron detector activated by nuclei heavier than the $He - 3$ of SAM 935 and the $Li - 7$ of detector *PM1703GN*. Following its arrival, confirmation of the background, and placement next to Klystron I operated as in the above reported first tests. detector 12-4 showed no neutron count at all for the entire day of the test. However, the following morning, after manually impacting the klystron, detector 12-4 showed apparent neutron counts at the rate of 50 cps for about one hour duration, namely a count much bigger than that by SAM 935 (as predicted, see below). A second impacting of the klystron produced identical results.

The traditional use of silver and gold foils placed around Klystron I was expectedly inconclusive because it showed various electron and photon emissions, but no clearly identifiable *conventional* emissions as expected from activation via the conventional use of a neutron flux.

A second series of measurements were initiated with Klystron II on August 8, 2006. Repeated tests produced no neutron detection. To simulate the "trigger" needed for the neutron synthesis, the test was repeated the following morning with an implosion due to the contamination of the chamber with air and the resulting $H - O$ combustion triggered by the arc. Despite the rudimentary nature

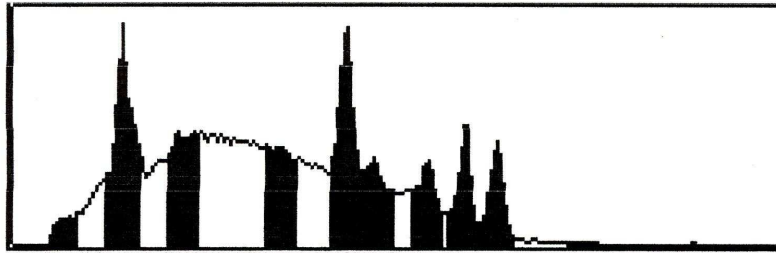

PEAKS FOUND

CHN	ENERGY (keV)	GROSS CPM	AMBIENT CPM	CONTINUUM CPM	NET CPM	UNC
16	27.0	22122	972	16148	5002 ± 4.25	
37	97.9	132198	8006	65824	58368 ± 0.89	
56	194.8	106786	7284	92488	7014 ± 6.70	U235s
87	424.4	90276	3602	85558	1116 ± 38.5	
110	646.5	128710	2760	68672	57278 ± 0.89	Cs137
118	739.9	67746	2180	60060	5506 ± 6.74	
137	974.9	60834	2026	40820	17988 ± 1.96	U238
149	1143.5	65446	1142	26070	38234 ± 0.95	Co60
160	1305.5	52112	860	16148	35104 ± 0.92	Co60
189	1819.3	4388	122	3498	768 ± 12.3	
210	2246.2	1542	20	1352	170 ± 32.8	
224	2543.3	1706	26	550	1130 ± 5.19	

2 OF 2 LIBRARY LINES FOR Co60 FOUND Correlation = 1.00
 LINE PEAK INTENSITY NET CPM
 1173.2 1143.5 99.90 38234
 1332.5 1305.5 99.98 35104

1 OF 1 LIBRARY LINES FOR Cs137 FOUND Correlation = 0.80
 LINE PEAK INTENSITY NET CPM
 661.7 646.5 90.00 57278

1 OF 1 LIBRARY LINES FOR U235s FOUND Correlation = 0.80
 LINE PEAK INTENSITY NET CPM
 185.7 194.8 57.00 7014

1 OF 1 LIBRARY LINES FOR U238 FOUND Correlation = 0.80
 LINE PEAK INTENSITY NET CPM
 1001.0 974.9 2.00 17988

NUCLIDES NOT PRESENT:

2 OF 3 LIBRARY LINES FOR U233 FOUND Correlation = 0.58
 2 OF 3 LIBRARY LINES FOR Ra226 FOUND Correlation = 0.05
 0 OF 1 LIBRARY LINES FOR Am241 FOUND Correlation = 0.00
 0 OF 7 LIBRARY LINES FOR Eu152 FOUND Correlation = 0.00
 0 OF 0 LIBRARY LINES FOR Name FOUND Correlation = 0.00

LINES NOT ASSOCIATED WITH ANY NUCLIDE:

Energy	Net CPM	Eff Corrected
27.0	5002.0	44976.7 C
97.9	58368.0	224471.0 C

Figure 6.29. Reproduction of the print out of a typical scan of detector SAM 935 when under neutron alarm.

of the equipment, this implosion caused, by far, the biggest neutron alarms in different detectors due to off-scale *cps* without any appreciable photon detection, as confirmed and documented by the print-outs. The laboratory was evacuated again for the rest of the day, residual counts persisted for days, and the test was not repeated for safety.

A third series of tests was initiated on December 20, 2006, with Klystron III filled up with commercial grade hydrogen at 100 psi, but the tests were quickly terminated for safety due to an excessive number of counts by the various detectors as well as the virtually instantaneous disintegration of the tips of the thoriated tungsten electrodes that prohibited an electric arc for the duration of at least a few seconds.

Following completion of the tests, the detectors were returned to their manufacturers for control; they were verified to operate properly; and the printout of all readings stored in their memory was released [119] confirming the measurements reported above.

Systematic reruns of the tests in early 2007 confirmed all the above detections, including in particular their anomalous behavior. However, all tests producing protracted off scale neutron alarms, such as those with implosion or at 100 psi hydrogen gas, were not repeated for safety.

No meaningful counts were detected with the above identified klystrons in using various gases other than hydrogen, although this should not exclude possible similar effects under sufficiently more powerful arcs. No neutron, photon or other radiation was measured from electric arcs submerged within liquids. Hence, the data herein reported appear to be specific for electric arcs within a hydrogen gas under the indicated conditions.⁵⁴

6.2.12.D Don Borghis Hypothesis of Neutroids

Recall that the synthesis of the neutron from protons and electrons has at least *two* quantum anomalies (that is, deviations from quantum mechanics), the first is given by the need of at least 0.78 MeV over the rest energies of the protons and the electron, and the second is given by the fact that the quantum spin $1/2$ of the proton and the electron cannot produce the spin $1/2$ of the neutron.

The usual "quick fix" to salvage Einstein special relativity and quantum mechanics, such as the assumption that the proton and the electron have 0.78 MeV relative kinetic energy, reveals a skin deep mind, because such an assumption

⁵⁴It should be indicated that E. Conte and M. Pieralice claimed in *Infinite Energy* of 1999 to have synthesized neutrons from protons and electrons. However, they abstained from quoting don Borghi in their original paper, resulting in denunciations of attempting to steal the scientific priority to a dead priest; they copied ad literal Santilli paper [95] without its direct quotation, resulting in a lawsuit at the U. S. Federal Court one can inspect at www.scientificethics.org; and their neutron detection has been the subject of criticisms so severe to prevent a review.

Alarm, neutron	9/2/2006/10:50:00 AM	53 Cps
Alarm, neutron	9/2/2006/10:56:00 AM	58 Cps
Alarm, neutron	9/2/2006/10:57:00 AM	34 Cps
The device off	9/2/2006/10:58:00 AM	
The device on	9/3/2006/3:05:00 AM	
Alarm, neutron	9/3/2006/3:05:00 AM	1 Cps
Alarm, neutron	9/3/2006/3:05:00 AM	1 Cps
Calibration	9/3/2006/3:06:00 AM	
Alarm, neutron	9/3/2006/3:07:00 AM	99 Cps
Alarm, neutron	9/3/2006/3:07:00 AM	99 Cps
Alarm, neutron	9/3/2006/3:08:00 AM	99 Cps
Alarm, neutron	9/3/2006/3:09:00 AM	99 Cps
Alarm, neutron	9/3/2006/3:10:00 AM	99 Cps
Alarm, neutron	9/3/2006/3:10:00 AM	99 Cps
Alarm, neutron	9/3/2006/3:11:00 AM	99 Cps
Alarm, neutron	9/3/2006/3:13:00 AM	99 Cps
Alarm, neutron	9/3/2006/3:13:00 AM	99 Cps
Alarm, neutron	9/3/2006/3:17:00 AM	99 Cps
Alarm, neutron	9/3/2006/3:17:00 AM	99 Cps
The device off	9/3/2006/3:17:00 AM	
The device on	9/3/2006/5:53:00 AM	
Alarm, neutron	9/3/2006/5:54:00 AM	1 Cps
Calibration	9/3/2006/5:54:00 AM	
Alarm, neutron	9/3/2006/5:54:00 AM	99 Cps
Alarm, neutron	9/3/2006/5:58:00 AM	99 Cps
Alarm, neutron	9/3/2006/5:59:00 AM	99 Cps
Alarm, neutron	9/3/2006/5:59:00 AM	99 Cps
Alarm, neutron	9/3/2006/5:59:00 AM	99 Cps
Alarm, neutron	9/3/2006/6:00:00 AM	99 Cps
Alarm, neutron	9/3/2006/6:02:00 AM	99 Cps
Alarm, neutron	9/3/2006/6:03:00 AM	99 Cps
Alarm, neutron	9/3/2006/6:04:00 AM	99 Cps
Alarm, neutron	9/3/2006/6:05:00 AM	99 Cps
The device off	9/3/2006/6:05:00 AM	
The device on	9/3/2006/7:45:00 AM	
Alarm, neutron	9/3/2006/7:46:00 AM	1 Cps
Calibration	9/3/2006/7:46:00 AM	
Alarm, neutron	9/3/2006/7:48:00 AM	99 Cps
Alarm, gamma	9/3/2006/7:58:00 AM	18 uR/h
Alarm, gamma	9/3/2006/8:03:00 AM	7 uR/h
Alarm, gamma	9/3/2006/8:03:00 AM	11 uR/h
Alarm, neutron	9/3/2006/8:04:00 AM	37 Cps
The device off	9/3/2006/8:09:00 AM	
The device on	9/3/2006/8:09:00 AM	
Alarm, neutron	9/3/2006/8:09:00 AM	1 Cps
Alarm, neutron	9/3/2006/8:09:00 AM	1 Cps

Figure 6.30. Reproduction of the print out of a typical scan of detector PM1703GN when under neutron alarm. Note the separation of the background as well as of gamma detections from neutron detections.

Alarm, neutron	9/1/2006/5:57:00 AM	99 Cps
Alarm, neutron	9/1/2006/5:58:00 AM	99 Cps
Alarm, neutron	9/1/2006/5:59:00 AM	99 Cps
Alarm, neutron	9/1/2006/6:01:00 AM	99 Cps
Alarm, neutron	9/1/2006/6:01:00 AM	99 Cps
Alarm, neutron	9/1/2006/6:01:00 AM	99 Cps
Alarm, neutron	9/1/2006/6:02:00 AM	99 Cps
Alarm, neutron	9/1/2006/6:02:00 AM	99 Cps
Alarm, neutron	9/1/2006/6:02:00 AM	99 Cps
Alarm, neutron	9/1/2006/6:03:00 AM	99 Cps
Alarm, neutron	9/1/2006/6:03:00 AM	99 Cps
Alarm, neutron	9/1/2006/6:03:00 AM	99 Cps
Alarm, neutron	9/1/2006/6:03:00 AM	99 Cps
Alarm, neutron	9/1/2006/6:04:00 AM	99 Cps
Alarm, neutron	9/1/2006/6:04:00 AM	99 Cps
Alarm, neutron	9/1/2006/6:04:00 AM	99 Cps
Alarm, neutron	9/1/2006/6:04:00 AM	99 Cps
Alarm, neutron	9/1/2006/6:05:00 AM	99 Cps
Alarm, neutron	9/1/2006/6:05:00 AM	99 Cps
Alarm, neutron	9/1/2006/6:05:00 AM	99 Cps
Alarm, neutron	9/1/2006/6:07:00 AM	99 Cps
Alarm, neutron	9/1/2006/6:08:00 AM	99 Cps
Alarm, neutron	9/1/2006/6:08:00 AM	99 Cps
Alarm, neutron	9/1/2006/6:09:00 AM	99 Cps
Alarm, neutron	9/1/2006/6:09:00 AM	99 Cps
Alarm, neutron	9/1/2006/6:09:00 AM	99 Cps
Alarm, neutron	9/1/2006/6:10:00 AM	99 Cps
Alarm, neutron	9/1/2006/6:10:00 AM	99 Cps
Alarm, neutron	9/1/2006/6:10:00 AM	99 Cps
Alarm, neutron	9/1/2006/6:11:00 AM	99 Cps
Alarm, neutron	9/1/2006/6:11:00 AM	99 Cps
Alarm, neutron	9/1/2006/6:14:00 AM	99 Cps
Alarm, neutron	9/1/2006/6:14:00 AM	99 Cps
Alarm, neutron	9/1/2006/6:15:00 AM	99 Cps
Alarm, neutron	9/1/2006/6:15:00 AM	99 Cps
Alarm, neutron	9/1/2006/6:15:00 AM	99 Cps
Alarm, neutron	9/1/2006/6:15:00 AM	99 Cps
Alarm, neutron	9/1/2006/6:15:00 AM	99 Cps
Alarm, neutron	9/1/2006/6:16:00 AM	99 Cps
Alarm, neutron	9/1/2006/6:16:00 AM	99 Cps
Alarm, neutron	9/1/2006/6:16:00 AM	99 Cps
Alarm, neutron	9/1/2006/6:16:00 AM	99 Cps
Alarm, neutron	9/1/2006/6:17:00 AM	99 Cps
Alarm, neutron	9/1/2006/6:17:00 AM	99 Cps
Alarm, neutron	9/1/2006/6:17:00 AM	99 Cps
Alarm, neutron	9/1/2006/6:17:00 AM	99 Cps

Figure 6.31. Reproduction of the print out of a typical scan of detector PM1703GN when under one of the continuous neutron alarms that required evacuation of the laboratory. Note the off-scale and duration of the alarm that disqualify as nonscientific other "interpretations" used to oppose measurements [119].

prevents the synthesis, as established by the quantitative representation of the neutron structure of the preceding sections. In fact, at the indicated relative energy, the $p - e$ cross section is of the order of 10^{-20} barns, at which value any synthesis is pure nonscientific nonsense.

The complexity of the neutron synthesis then emerges in its full light, jointly with the grossly insufficient character of our knowledge. These and other factors suggest caution prior to venturing claims on the full synthesis of the neutron, and this explains the reason for the title of paper [118] reporting measurements 'toward' the neutron synthesis.

Along the above lines, we can safely state that an electric discharge within a hydrogen gas at a few psi pressure and atmospheric temperature (as above described) produces "entities that:

- 1) Are not hydrogen atoms (because in that case no nuclear transmutation would be conceivably possible);
- 2) Have dimensions of the order of 1 fm as for all hadrons (otherwise the detectors would show no counts);
- 3) Are neutral (otherwise they would not move through walls);
- 4) Are stable for hadron standards (more accurate data being grossly premature at this writing);
- 5) Remain initially confined within the arc chamber under steady conditions, to slowly exit, except for the case of production under implosion causing rapid propagation;
- 6) Are generally released hours following the tests, with anomalous counts lasting for weeks;
- 7) Are not neutrons (otherwise we would have ordinary neutrons detections).

In fact, *all detectors systematically behaved in an anomalous way*, namely, in a way different than that for direct neutron detection as defined by the manufacturers of the equipment. This is clearly illustrated by a kind of "detectors self-activation" since detector *PM1703GN* entered into neutron alarm with no photon count while driving miles away from the test at about 15m following exposure to Klystron I. The anomalous behavior was confirmed with reruns in different directions from the lab via the use of detector *PM1703GN*. The other detectors also showed similar anomalous behavior, although with different delay times.

The most plausible interpretation is that the tests produced "entities" other than neutrons that were absorbed by nuclei of the detectors, then causing nuclear transmutations that, following a delay time, produced ordinary neutrons. In different words, the delayed detections here reported for Klystron I do indeed refer to actual neutrons, although originating from nuclear transmutations caused by the original emissions, and not from the original emission itself.

In view of the above and other anomalies, don Borghi introduced the name of *neutroids* for the entities produced inside the klystron (see below Lino Daddi historical account). We believe that the differentiation between neutrons and neutroids is quite appropriate. Consequently, to initiate quantitative studies on neutroids we we present the following:

HYPOTHESIS 6.2.12A [118]: Under steady conditions, thus excluding implosions and other impact events, a steady electric arc within a hydrogen gas at a few psi pressure and atmospheric temperature produces a new particle called neutroids and denoted with the symbol \tilde{n} , having the values (in nuclear units) $A = 1, Z = 0, J = 0, u = 0.008$, and we shall write

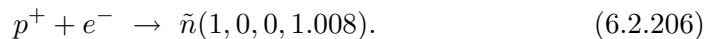

Note that the value $J = 0$ is assumed for the primary purpose of indicating that the total angular momentum is assumed as being conventional, thus not excluding non-null integer values requiring separate study not considered at this time. Also, the rest energy of the neutroids is assumed as being that of the proton in atomic mass units $1u = 931.49MeV$, $m_p = 938.27MeV = 1.0078 \approx 0.008u$ (see the Tables of Nuclides <http://atom.kaeri.re.kr/>) because the electron mass $0.511MeV = 0.0005 u$ is ignorable for our approximation and the $p - e$ binding energy of Coulomb nature is excessively small for our approximation, being of the order of $10^{-3}MeV$).⁵⁵⁵⁶

Our tentative interpretation at this limited level of our knowledge is that, the geometry of the electric arc is quite conducive to processes causing the synthesis of neutron-type particles. By recalling that the magnetic field created by an electric arc is directly proportional to the current and inversely proportional to the distance, in the conditions of tests [118], protons and electrons are exposed to magnetic field with an intensity of the order of $10^8 G$ when at atomic distances from the arc.

Under so powerful a magnetic field, the geometry of the electric arc first aligns protons and electrons with their magnetic moments along the tangent to the local magnetic force (Figure 6.32). Subsequently, the same geometry is predicted to cause protons and electrons to collapse into a neutral, hadron-size particle due to

⁵⁵It should be noted that neutroids are expected as being created also with means other than electric arcs within a hydrogen gas. The best illustration is given by numerous known reports of neutron emissions from electrolytic cells with beryllium electrodes saturated with hydrogen, which radiations could be mainly due to neutron synthesis rather than sole emissions from nuclear transmutations as interpreted so far.

⁵⁶It should be indicated that various other names have been suggested for possible bound states of a proton and an electron below Bohrs orbit, including "mini atoms," "hydrino," and others (see Lino Daddi presentation below). Note, however, that the study herein considered under the name of neutroids refers, specifically, to hadrons, while other studies have different aims .

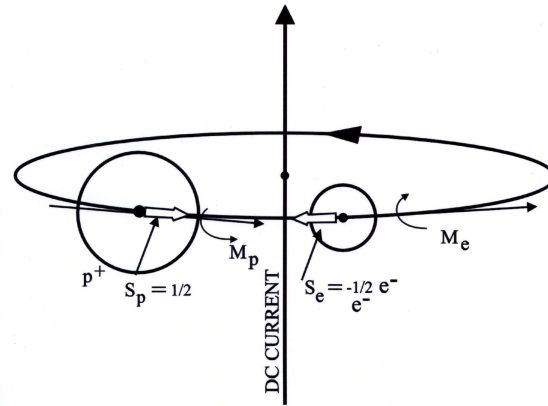

Figure 6.32. A schematic view of the alignment of protons and electrons along a magnetic force line of a DC electric arc.

the very strong Coulomb attractions at short distances of both, opposite charges and opposite magnetic polarities (Figure 6.33).

Quite intriguingly, we cannot exclude the possibility that some of the entities produced by the arc are ordinary neutrons. In fact, the behavior of all detectors for the case of the tests with implosion caused by hydrogen combustion was fully normal and, in particular, without self-activated delayed detection, thus suggesting the production of ordinary neutron.

Similarly, the off-scale neutron alarms with no photon detection were so intense for the tests with klystron III at 100 psi hydrogen gas, that the direct production of neutrons simply cannot be excluded at this writing. The point is that the joint production of a kind of "intermediate" particle between the hydrogen atom and the neutron cannot be excluded either.

Also, at this stage of our quite limited knowledge, we cannot exclude that the addition of high frequency microwaves and related resonances may have caused the production of neutrons in the original experiment by Don Borghi and his collaborators [116]. Note that detectors suitable to identify whether the transmutations originated from the actual production of neutrons, or they originated from neutroids, were not available for tests [116].

Whatever their interpretation, we can safely state that *Santilli's experiment [118,119] confirms Don Borghi's experiment [116,117] because tests [118,119] detected nuclear transmutations on various substances placed in the vicinity of the klystrons, which transmutations are the main claim of Ref. [116-117].* To be scientific, different views should provide a *quantitative* elaboration of the differences

between the two tests, namely, should *prove* that the nuclear transmutations of tests [116,117] are incompatible with those of tests [118,119].⁵⁷

To prevent denunciations of scientific corruption, readers are suggested to avoid the use of quantum mechanical theologies for the dismissal of the above detections, such as the well known impossible existence for quantum mechanics of a bound state $p - e$ at short distances due to the uncertainty principle and other reasons (see Section 6.2.2).

In fact, quantum mechanics is exactly valid for the hydrogen atom, that is, for the dynamics of an electron moving in empty space at relative large distances from a proton. By comparison, the validity of the same discipline for the dramatically different case of the electron moving within the hyperdense medium inside the proton is a pure personal theology without any theoretical support, let alone experimental verifications. Hence, the use of quantum mechanical theologies for the dismissal of new measurements indeed scientific corruption for personal gains.

The application of quantum theologies to the neutroids would imply that the electron freely orbits within the hyperdense medium inside the proton which is nonscientific nonsense. Additionally, we have shown in preceding sections that the neutron is constituted by an electron *constrained* within the proton by said hyperdense medium, under which conditions the use of quantum mechanical theologies for the dismissal of measurements is indeed a crime against society.

6.2.12.E Again, Continuous Creation from the Synthesis of the Neutron?

As indicated in the preceding subsection, we have adopted Don Borghis hypothesis of the neutroids for scientific caution. In this subsection we would like to indicate that *any claim of production of actual neutrons in the set-up of tests [116-119] implies the admission of the continuous creation of matter according to the etherino hypothesis*. Hence, rather than disappearing for the comfort of Einsteinian interests, the hypothesis of continuous creation originated in quantitative studies on the neutron structure, reappears rather forcefully in the laboratory synthesis of the neutron, and will emerge again in the neutron decay of the subsequent section.

The above scenario originates from the following facts:

1) When the proton and the electron have a relative energy of 0.78 MeV the synthesis of the neutron is impossible for the indicated reasons, thus leaving as

⁵⁷It should be also noted that hydrogen atoms with orbits smaller than conventional ones have been predicted in the literature (see, e.g., ref. [120] and papers quoted therein). However, these studies are aimed at processes related to *anomalous atomic orbits*, while our studies deal with *anomalous nuclear hadronic-type particles*.

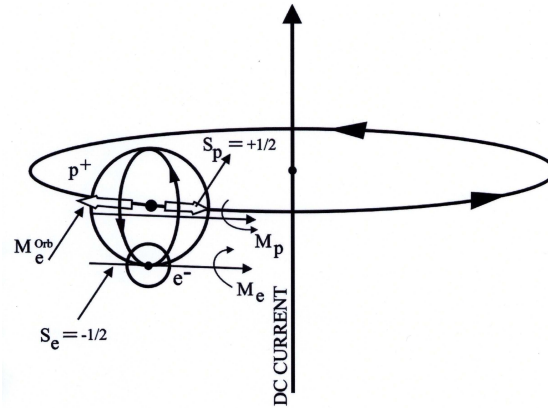

Figure 6.33. A schematic view of the neutroids expected from the collapse of the electron into the proton structure following the alignment of the preceding figure due to very strong, attractive, electric and magnetic Coulomb forces at $1F$ mutual distances due to opposing charges and magnetic polarities. Note that the coupling is in singlet, as necessary for any bond, and it is of axial character, namely, the spin of the proton and of the electron are initially aligned along a single symmetry axis. Following penetration inside the proton, the electron is expected to acquire conventional integer angular momenta, along the lines of Figure 6.23.

only possibility for the neutron synthesis that the proton and the electron are essentially at rest with respect to each other;

2) The transfer of 0.78 MeV from the physical environment to the neutron is indeed plausible for the neutron synthesis in the interior of the Sun due to its density, but the same assumption makes no sense for the comparatively insignificant hydrogen density of the tests here considered; thus, leaving

3) The only plausible explanation for the synthesis of the neutron inside the klystrons of tests [116-119] is the the origination of the missing energy of 0.78 MeV from the ether as a universal medium of very high energy density according to the etherino hypothesis.

We can then conjecture that, in the simplistic geometry of Figures 6.32 and 6.33, following penetration inside the proton, the electron is constrained to orbit with a quantum mechanical angular momentum, resulting in the neutroids, in which case there is neither an energy nor a spin anomaly. Note that in this case the initial relative kinetic energy of the proton and the electron is ignorable.

On the contrary, when the neutron synthesis occurs in the core of a star, the electron may be compressed all the way to the center of the proton, resulting in both the energy and spin anomalies. This speculation appears as being compatible with the hadronic structure model of the neutron forcefully indicating the at rest condition of the electron inside the proton, e.g., for the isorenormaliza-

tion of its mass. The same conjecture appears compatible with the cases of tests [118,119] suggesting the apparent true production of neutrons, such as those with implosion, high pressure, or other "triggers" of hadronic mechanics. Note that in the latter cases too the initial relative kinetic energy of the proton and the electron is ignorable.

As we shall see in the application of the studies herein presented well under way in the industry (and positively not in contemporary academia), the issue as to whether the electron is at rest or not when compressed inside the proton, has a primary relevance for possible new clean energies.

To understand the dichotomy here alluded to, the reader should note that, for industrialists who are currently investing substantial sums of *their* money, the proton and the electron are massive, permanently stable particles that simply cannot "disappear" at the time of the neutron synthesis. Hence, the neutron must be a kind of bound state of a proton and an electron.

By contrast, for academia abusing *public* funds, everything goes. One just needs a few accomplices at "leading" institutions and you get public funds for any desired theory. In fact, as denounced at the initiation of Section 6.2, for contemporary academia, the proton and the electron "disappear" at the time of the neutron synthesis as being replaced by hypothetical directly undetectable quarks without gravity and confinement. Additionally, at the time of the neutron decay, hypothetical quarks "disappear" while the proton and the electron "reappear," and, to complete the adaptation of nature to organized Einsteinian interests, there is the conjecture of another directly undetectable hypothetical particle, the neutrino, claimed as being "detected" via the abuse of scientific credibility and public funds.

One statement can be made with absolute certainty: public money can be easily obtained for academic games via the support of brothers at governmental agencies, but Santilli can testify that none of the industrialists he knows in three continents actively working on new clean energies would give one penny of their money to so farfetched adulterations of nature for personal gains.

In summary, all the above measurements and analyses establish beyond "credible" doubt the very motivation for the birth of hadronic mechanics in 1978 [14], namely that *the structure of the neutron, including its synthesis of this section and its stimulated decay of the next section, signal the truncation of the validity of all Einsteinian doctrines and quantum mechanics, since the usual intentional adulterations via the addition of ad hoc parameters (thanks God!) are no longer effective.*

Still in turn, this illustrates the reason seemingly reputable and indeed fully qualified scientists, such as Sidney Coleman, Steven Weinberg, Sheldon Glashow and their rapidly decreasing number of followers around the world, perpetrated such extreme gestures of scientific obstructions against new studied on the struc-

ture of the neutron as those summarized in Footnote 1 of this volume, reviewed in details in book [89] and documented in the 1,132 pages of the three volumes [90], the latter ones now being available as free download from the indicated web site. Still, in turn, this illustrate that the presentation of new experimental studies on the synthesis (and stimulated decay) of the neutron without the joint open denunciation of the organized scientific crime in the field, would be a false serious scholars should abstain from for their own dignity, let alone for any serious pursuit of new human knowledge.

6.2.12.F Tentative Interpretation of Don Borghi and Santilli Experiments

The idea that the experimentalists of tests [116,117]. two of whom being Catholic priests, have lied in their claims is so ludicrous that can only be proffered by immoral outcasts. Hence, in this work we have assumed that the claims of Refs. [116,117] are true, namely, that the various substances placed in the exterior of the klystron experienced nuclear transmutations due to a flux of *neutrons*.⁵⁸

Needless to say, it is unknown as to whether said final neutron flux originated from the interior of the klystron, or it is due to secondary processes, such as those in the activated substances themselves or in the walls of the klystron.

In the hope, but not the certainly, of achieving an interpretation of the above measurements while avoiding continuous creation of matter in the universe, we assume that neutrons are synthesized by nuclear furnaces, namely, we assume that *neutroids are turned into neutrons when absorbed by nuclei*, and we shall write

$$\tilde{n}(1, 0, 0, 1.008) + a \rightarrow n(1, 0, 1/2, 1.008), \quad (6.2.207)$$

where a is the aetherino or etherino, namely, the entity permitting the energy, spin and other anomalies in the synthesis of the neutron that will not be addressed in this subsection for simplicity.

The above reaction is pure nonsense for quantum mechanics but quantitatively treated in a numerically exact and invariant way by hadronic mechanics as studied in detail in the preceding sections.

Once immersed within nuclei, there is a realistic possibility of identifying the missing 0.78 MeV from vibrational and other nuclear sources (rather than from the vacuum), and the nuclear furnace has the density sufficient to compress the electron deep inside the proton, resulting in the hadronic interpretation of the spin without any need for conjecturing hypothetical neutrinos, as per preceding studies.

⁵⁸Beside the late Don Carlo Borghi, Don Camillo Giori is also a Catholic priest still active in a church in Parma, Italy. Unfortunately, Don Giori has been so harassed by the organized scientific crime on Einstein, that he refuses to talk to anybody about his experiment with Don Borghi.

Note that *the above assumption is sufficient alone, to represent "all" Don Borghi's data [116,117]*, although, to separate quantitative science from epistemology, the reader should keep in mind that the above statement required a lifetime of research summarized in this and in the preceding three volumes of this series.

Under the above view, the substances placed by the experimentalists around the klystron of tests [116,117] absorb a large number of neutroids that, when inside nuclei, are turned into neutrons, thus creating the activation detected in the tests.

To initiate this study, we assume the usual symbol $N(A, Z, J, u)$ for ordinary nuclides as currently known, and the symbol $\tilde{N}(A, Z, J, u)$ for possible anomalous nuclides, namely, nuclides following the absorption of a nuclid not existing in available data, here called *nuclidoids*. We also assume that the binding energy of the neutroids is similar to that of an ordinary nucleon (e.g., $BE = 0.0002 u$ for the deuteron), which assumption is a direct consequence of conversion (6.2.207). Then, for the case of gold, we have

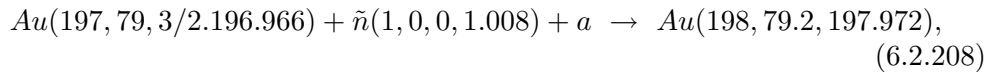

and, similarly, one recovers all conventional activation processes.

By comparison, the application of the above assumption to the steel casing of Don Borghi klystron yields an unknown nuclidoid

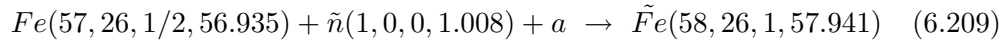

since the tabulated nuclide is $Fe(58, 26, 0, 57.933)$.

Needless to say, the anomalous nuclide $\tilde{F}e(58, 26, 1, 57.941)$ is expected to be highly unstable and decay in a variety of possible modes, although they do not appear to provide the source of neutrons necessary to represent Don Borghi data.

This excludes that the neutrons in Don Borghi experiment were synthesized in the walls of his klystron and confirms, quite preliminarily of course, that the neutrons were synthesized by the activating substances themselves.

Hypothesis (6.2.207) also interprets some of Santilli detections [118,119], with the understanding that the anomalous behavior of the detectors, such as the delayed neutron counts, requires special studies and perhaps the existence of some additional event not clearly manifested in Don Borghi's tests.

To initiate the study, we have the first possible reaction

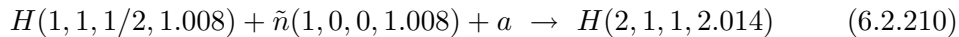

namely, we have the prediction that, under transmutation (6.2.207), the coupling of a neutroid by a proton creates the ordinary deuteron.

The understanding of this statement requires a study of the deuteron via hadronic mechanics conducted in the nuclear section of this chapter (Section 6.3).

In particular, such an understanding requires the scientific honesty to admit that quantum mechanics failed to achieve an exact representation of the simplest possible nucleus, the deuteron, following one century of attempts and a river of public money, since:

1) Quantum mechanics miserably failed to represent the deuteron spin 1 (the ground state of two particles with spin 1/2 must be 0 for quantum mechanics due to the singlet coupling mandated by stability);

2) Quantum mechanics miserably failed to achieve an exact representation of the deuteron magnetic moment despite all quarks manipulations (the hypothetical orbits of the hypothetical quarks are excessively small to make and appreciable contributions to magnetic moments)

3) Quantum mechanics miserably failed to achieve a meaningful representation of the stability of the neutron when coupled to a proton. Should we continue with embarrassing insufficiencies?

As we shall see in Section 6.3, *all* these century old problems are resolved by assuming that *the deuteron is a three-body structure composed by two protons and one electron verifying hadronic mechanics, which structure can be interpreted in first approximation as a two-body system composed by a proton and a neutron verifying quantum mechanics*, the understanding that in the latter approximation nuclear physics ceases to be an exact science.

Reaction (6.2.210) Indicates that the hydrogen content of the polycarbonate walls of Santilli's tests [118,119] do cannot possibly be considered a source of the detected neutrons.

said polycarbonate contains about 75 % carbon, in which case we have the tentative reaction

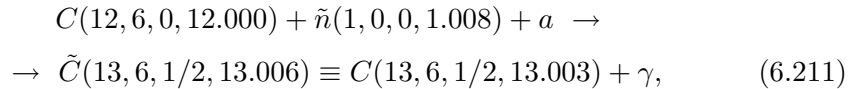

thus excluding the carbon of the polycarbonate can be a source of the detected neutrons.

Finally, said polycarbonate contains about 18.88 % oxygen for which we have the reaction yielding an unknown nuclidoid

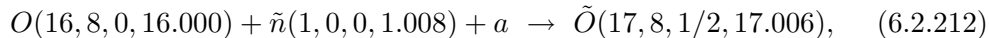

because the known nuclide is $O(17, 8, 5/2, 16.999)$. The latter reaction too is not expected to provide the neutron counts detected by Santilli.

In conclusion, in Santilli's experiment too, it does not appear that the detected neutrons are synthesized by the walls of the klystron. This leaves as the only residual possibility that the neutrons are synthesized by the detectors themselves. To study this possibility we consider the reaction for the He_3 -activated detector

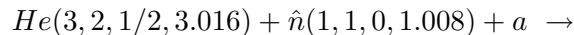

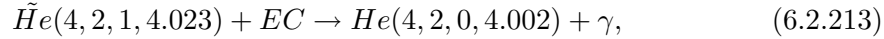

in which, as one can see, the detection of the neutroids is anomalous if any.

Next, we have the reaction for the *Li*-activated detectors

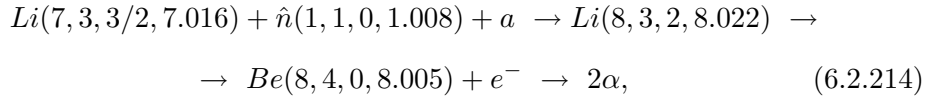

that do indeed behave in a way fully equivalent as to whether the detection refers to neutroids or neutrons.

Finally, for the base of *B*-activated detectors we have the reactions

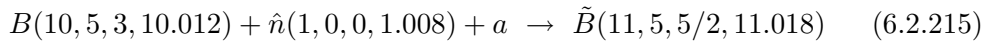

with the predicted spontaneous decay

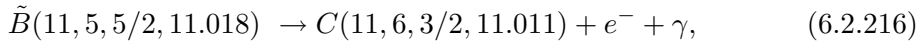

that do not appear to behave normally under a flux of neutroids.

From the above reactions we can see a conceivable explanation of the reason the *He*₃-activated detector resulted as being the least active of all in tests [118-119]. We can also see a plausible reason for the *Li* – 7 activated detector as being the bests for Santilli’s experiment, and that’s the reason for mandating the use of *Li*-activated detector for any reruns of Santilli’s experiment (unless the rerun is commissioned to fake it, as indicated below, in which case care is taken to avoid its use).

Our tentative conclusion is, therefore, that *the neutrons detected in Don Borghi experiment [116,117] were synthesized by the nuclei of the activated substances, while the neutrons of Santilli experiment [118,119] were synthesized by the detectors themselves, either by their activating substance, or by their casing, the latter expected to be the origin of the delayed detection.* For instance, the explanation of the large delayed counts by the *BF*³ activated detector requires a study of the absorption by its plastic casing that cannot be possibly done in this initial study.

In closing, the reader is warned against superficial conclusions, no matter how appealing. In fact, we remain with the possibility that *in Santilli’s experiment, the neutroids are produced in clusters*, something reminiscent of electron clusters, but deeply connected to the new chemical species of heavy hydrogen presented in Volume V, Chapter 10 in particular. Regrettably, we cannot study this aspect at this time since it requires the prior knowledge of the entire Volume V of this series.

Yet, the latter possibility would provide a clear explanation of the large neutron counts experienced by Santilli, so intense to force various evacuations of the laboratory. In fact, it is easy to see that, if neutroids are absorbed by stable

elements in clusters such as $\tilde{n} \times \tilde{n}$, $\tilde{n} \times \tilde{n} \times \tilde{n}$, ..., following their conversion into neutrons by nuclei they would result in an excess of neutrons that can be corrected by nature with the emission of neutrons. In this case, *all* substances near the experiment, whether the walls of the klystron or the substances composing the detectors, would become a source of the detected neutrons.

A reason for suspecting the creation of neutroids in clusters in Santilli's rather than in Don Borghi's experiment is due to the much bigger power of the electric arc used by Santilli's as compared to that in Don Borghi's tests, as well as by a number of anomalous features of sufficiently powerful electric arcs, all irreconcilably incompatible with Einsteinian doctrines (see Volume I, Section 1.2.13), one of which is a radial compression of polarized structures, whether atoms or hadrons, toward the arc, thus naturally creating clusters.⁵⁹

In conclusion, what is needed by the fundamental problem of the neutron synthesis is what it has been denied so far by academic corruption, the conduction of systematic and all encompassing measurements by a large laboratory with the necessary equipment that could not possibly be available for tests [116-119].⁶⁰

6.2.12.G Daddi's Studies on Don Borghi's Experiment

In this section we report *ad litteram* the studies on the laboratory synthesis of the neutron conducted by Lino Daddi, former professor at the Naval Academy of Livorno, Italy, Via degli Oleandri 24, I-57128 Livorno, Italy, email linodaddi@hotmail.com

This subsection presents and comments the data deduced from two versions of the experiment carried out at "Centro de Energia Nuclear", of Pernambuco University (Brazil). Both versions [116, 117] are in English, having the same title: *EXPERIMENTAL EVIDENCE ON THE EMISSION OF NEUTRONS FROM COLD HYDROGEN PLASMA*.

Here the first version will be indicated with [A]. It is an internal report of the "Centro": Comunicação no. 25 of June 1971. It is ascribed to two Research Workers of board: Carlo Borghi (Director) and Attilio Dall'Olio (transferred from Parma University), while Camillo Giori (Parma University but in licence at "Centro") is thanked for the help in organising the experiment. This [A] version

⁵⁹Any welder knows that, under a DC arc, electrodes are attracted to each others and they have to pull one electrode away from the other to create an arc. This feature, very well known in the industry, is carefully kept away from physics courses because it deals with a longitudinal (axial) force called *Ampere force* that is prohibited by Maxwell's equations and Einsteinian doctrines, and, consequently, it does not exist. This academic immorality is also excellent to fake Santilli's experiment. Indeed, one can rerun experiment [118,119] by ignoring the Ampere force, in which case there is a short, rather than an arc, resulting in the desired lack of production of neutroids.

⁶⁰Widespread vulgar academic corruption on Einsteinian doctrines turns the insufficiency of the equipment used in tests [116-119] as a "motivation" for their dismissal, rather than their reruns with better equipment, for evident immoral personal gains in the immoral continuation of immoral abuses of academic power, prestige and public funds.

was presented to “First Brazilian Symposium on Radioisotopes”, held at Rio de Janeiro in June 1970. Almost all measurements were performed in the six previous months.

The [B] version probably was prepared for an external publication (Authors: Borghi-Giori-Dall’Olio) and almost immediately was translated in Italian by Boscoli for a monograph of Andromeda (publisher in Bologna). After don Borghi death (happened in 1984) this [B] paper was published, without changes, in 1993 on vol. 56 of Phys. At. Nucl., page 339.

The versions are enough coincident in the description of a number of nuclear measurements. However the [A] version contains the results of some measurements which are not referred in [B] one, whereas the use of uranium is referred only in [B]. So a careful comparison between the [A] and [B] versions seems useful. My remarks will be pointed out under the [D] symbol.

In [A] the Authors are inclined to think the produced neutrons are epithermal (50–300 eV) whereas on [B] no opinion on neutron energy is asserted.

Don Borghi stated the following objet for its experiment.

[A] [B] ... in order to answer the question whether there is a proton-electron interaction different from the Coulombic one.

... there must be per unit time a very large number of electrons targeting the protons and vice-versa, since every one of such events is a chance for the hypothetical other interaction to work. These conditions are fulfilled when we have a resonant cavity filled with pure hydrogen at low pressure. mixture of free protons and free electrons called a “cold plasma”.

[D] Nevertheless I think the proton-electron reactions could take place inside of the walls rather than inside of the cell. The solid walls could absorb protons as in various LENR experiments. The uncertainty of interpretation doesn’t reduce the importance of the nuclear transmutations obtained in this experiment.

THE EXPERIMENT

The hydrogen

[A] About 10–20 cm³ of hydrogen (S.T.P.) per hour flow into the klystron (highly ionized pure hydrogen at low pressure , 10⁻¹ Torr). It is produced by electrolysis, (water + H₂SO₄), with a current of \cong 1 A.

When the klystron contains other gas than pure hydrogen (for instance, air) no neutron flux is observed. This detail is critical, so that also a small leakage in the vacuum system reduces severely the observed flux of neutrons.

[B] The hydrogen has been always obtained by electrolysis (water + H₂SO₄), dried on silica and filtered through a vacuum tight Palladium tube (25 cm long, 0.5 cm diameter, 0.1 cm thick). The pressure of the gas in the oscillator is about 0.1 Torr.

[D] The opinion of Don Borghi the $p + e$ reaction happen in cold plasma could be wrong. The protons (but also the electrons) may be more numerous in the walls than in the cold plasma (were the pressure is very low indeed).

The $p + e$ reactions could concern the absorbed protons in the walls, according to nuclear reactions in condensed matter (LENR).

The deuterium

[A] [B] The Deuterium percentage in the input flow of hydrogen into the klystron is 1/1000. Therefore in 5 cm^3 at 0.1 Torr pressure the number of D atoms is about 10^{13} , versus 10^{16} of H.

D+D fusion

[A] [B] Possible $d - d$ reactions could actually exist in the klystron if

a) some noticeable amount of deuterium is adsorbed by the inner wall, which is of stainless steel;

b) a beam of D ions with sufficient energy falls onto these D-imbedded walls. A threshold of about 5000 V is required, whilst the klystron works at voltage of 500 V.

[D] The probability of the D+D reaction is judged very little.

Cold plasma

[A] The mechanism of ionization here used permits the permanence of positive ions together with an approximately equal number of electrons in the same volume. This mixture, possible because of the extremely high frequency, is referred to as "cold plasma" of hydrogen.

[B] The "cold plasma" is a considerable number of protons mixed and colliding with an equal number of free electrons, for a time very larger than 10^{-8} sec. This limit is suggested by the known average recombination time of the ionized hydrogen atom.

Millimetric waves

[A] Metallic (stainless steel) UHF oscillator for 4 mm wavelength for ionizing the low pressure hydrogen in the klystron-like oscillator. The peak-to-peak voltage of the microwave e.m. field does not reach to 5000 Volt (the minimum required by D+D reaction); thus is very improbable that D+D reaction contributes to the observed neutron production.

[B] The high frequency has been taken of the order 10^{10} Hertz, with amplitude large enough for ionizing the low pressure pure hydrogen contained in the resonant cavities of a klystron-like oscillator.

[D] An external probe should be necessary in order to ascertain the microwave features. If their stability will be verified, a qualitative monitoring could be committed to a nuclear counter (see item on BF_3 counter).

The cooling / moderating water

[A] The metallic klystron is cooled by a stream of water circulating onto its external wall. The cooling water shield is 1 cm thick

[B] A cooling water flow is necessary, but the cavities containing the plasma are settled outside the cooling layer, so that eventual particles outgoing from them don't cross through the water.

[D] On this argument [A] [B] are not too different, if one thinks the neutrons are produced with very low velocity.

[A] ... samples setted nearby the outer wall of the klystron, at a distance of about 15 cm from the cavities where the cold plasma is produced. The area of samples is about 4.52 cm^2 , thus the solid angle is 1.6×10^{-3} sterad. The neutron emission is assumed to be spherically isotropic.

[D] The above quotation confirms between neutron source and the neutron detectors no moderator is interposed.

Indeed the solid angle is calculated by supposing no scattering of neutrons, just as when no moderator is interposed.

Neutrons or neutroids?

[A] The aim of the present work was only to show the existence of that neutron flux, whilst a more detailed analysis of both intensity and energy spectrum will be object of further works already on the way.

[B] When some proton and electron form the just said neutral bound states, then they behave possibly as neutrons and can cross throughout the walls of the oscillator.

[D] In precedent works Don Borghi named "neutroids" the hypothetical shrunk neutral particle formed by a proton and an electron (hydrogen miniatom). Such a compression is forbidden by the usually accepted interpretations of the Uncertain principle. Other Authors, by utilizing different theories, adopted the names "virtual neutron" (Chatterjee [121]), "hydrino" (Mills [122]), "hydrex" (Dufour [123]), "mass modified hydrogen atom" (WIDOM³ [121]), "hydrogen miniatoms" (Daddi [124]).

Beta particles detector

[A] [B] The resulting activities have been measured by means of a Philips anticoincidence system with a steadily low background 0.9 ± 0.1 cpm.

[D] The efficiency of beta counting depends on various factors, which have to be estimated. Very important is the self-absorption factor, which depends on the thickness of the source. The activation samples used by Don Borghi are quite thick, so the percentage of the emitted beta-particles which reach the detector is often little.

Gamma rays detector

[A] [B] The gamma activity was measured by a well crystal NaI(Tl) phototube (Tracerlab 1“x1”)

[D] The gamma efficiency of this well scintillator is certainly too low. Above all no spectrometric measurement is practically possible with it. So no acceptable energy determination is possible.

BF₃ counter

[A] [B] The large noise due to the microwave field of the klystron makes the signal from BF₃ detectors uncertain, also with careful electric shielding.

[D] This difficulty may turn in an advantage, by using a proportional nuclear counter (perhaps also different from BF₃ type) in order to qualitatively monitoring the primer of the klystron. This method should be confirmed by e.m. measurements.

Activation detectors for neutrons

[A] [B] This neutron flux has been prevalently measured by the activation of samples of several elements mostly obtained from the Atomic Energy of São Paulo (see Table 6.1). From a qualitative standpoint all the samples, after a conveniently long exposure near the external wall of the klystron (for hours or several days or months) show an activity clearly many times above any reasonable fluctuation of the background.

[A] A great care having been taken in order to avoid contamination.

[B] ... as well as evident decays with short periods, whose origin cannot be other than a recent activation.

[D] The (n, γ) capture cross sections depend on the neutron velocity according to a law of the type $1/v$, so they are highest for slow neutrons (saving the presence of resonances for particular values of the energy).

Actually Don Borghi assumes in [A] version the neutrons are produced with epithermal energy, in the range 50–300 eV. This conviction derived from the verified activation of resonance detectors used in the experiment (Tl and Pr). But the non-moderation seems be unjustified, because the higher induced radioactivities would made the measurements more reliable.

They should be improved also by utilizing simple technique as the “cadmium cutting”.

Table 6.1. Activation detectors

Detector (%)	Capture thermal cross section (barn)	Most important resonance cross section, barn (eV)	Produced radioisotope ($T_{\frac{1}{2}}$)	Principal activities (energy in MeV)
^{115}In (96)	157	29000 (1.4)	$^{116}\text{In}^*$ (54 m) [†]	β 1/0.8/06 γ 1.27
	52		^{116}In (14 s)	β 2.9
^{107}Ag (51)	45		^{108}Ag (2.4 m)	β 1.77
^{109}Ag (49)	113	12000 (5.1)	^{110}Ag (24 s)	β 2.2/2.8
^{197}Au (100)	96	30000 (4.8)	^{198}Au (2.7 d)	β 0.96 γ 0.41
^{164}Dy (28)	2600	7500 (54)	$^{165}\text{Dy}^*$ (1.26 m)	IT
	800		^{165}Dy (2.3 h)	β 0.42/0.88/1.25 γ 0.09/0.28
^{121}Sb (57)	6	1400 (6.2)	^{122}Sb (2.8 d)	β 1.4/2.0 γ 0.56
^{123}Sb (43)	2.5	1200 (2.2)	^{124}Sb (60 d)	β 0.6/2.4 γ 0.6
^{55}Mn (100)	13	1950 (337)	^{56}Mn (2.6 h)	β 2.8/1.05
^{141}Pr (100)	11	500 (23)	^{142}Pr (19 h)	β 2.17 γ 1.6
^{203}Tl (29.5)	8	450 (230)	^{204}Tl (3 y)	β 0.76
^{93}Nb (100)	6		^{94}Nb (6.2 m)	IT

[†]Note: transition from $^{116}\text{In}^*$ to ^{116}In is forbidden.

Irradiation geometry

[A] samples setted nearby the outer wall of the klystron, at a distance of about 15 cm from the cavities where the cold plasma is produced. The area s of samples is about 4.52 cm², thus the solid angle is 0.0016 sterad.

[D] The solid angle is not 0.0016, but $s/R^2 = 0.02$ sterad. By dividing for 4π sterad (total solid angle) one obtains the geometry factor (probability) which equals, just, 0.00016.

RESULTS OF THE EXPERIMENT

Decay evaluations

[A] [B] For low level of induced radioactivity the measure has been made by an average in a time as long as possible, and when possible the half lives have been checked with the least squares method.

[D] Even if some graphs are not very clear, on the whole they are suitable for follow the activation and/or the decay, and for a qualitative control of the half-life of the produced activities.

Treatment of the statistical fluctuations

[D] The propagation of the statistical errors not seems always correctly treated. Indeed the Authors sometimes have not chosen in the better way the counting times in order to minimize the fluctuation importance.

For instance, the graphs concerning the indium and the silver can be utilized with difficulty owing to the statistical fluctuations. The standard errors in the thorium measurements (in c.p.m.) were evaluated as if the counting time was one minute (but the induced activity decays in several days!)

Activation of indium, silver and gold.

[D] Fig. 8 and Fig. 9 of [A] version present the activation and decay graphs for gold and silver. In significant Fig. 8 the gold beta activity increases and decreases at least twice. The activated gold would be measured with greater confidence and lower background in gamma-ray spectrometry thank to 411 keV photon the ^{198}Au emits. The activation of indium and silver consists in beta-emitters radioisotopes. Indium presents a strong resonance (29000 barn) at 1.44 eV; gold presents a strong resonance (34000 barn) at 4.8 eV.

These detectors, exposed bare and in a cadmium sheath, would provided, by difference, an answer to the question if the neutrons were thermal or epithermal. Don Borghi (see item on Pr, Nb and Tl) said (in [A]) convicted the energy range was put between 50 eV and 300 eV.

Activation of dysprosium and antimony

[D] The dysprosium proved to be a very good neutron detectors; that was foreseeable for the high value of the capture cross section, and for the favourable counting property of the ^{165}Dy , which half-life is 2.3 hours.

The decay curve obtained is clean and convincing. The dysprosium results could be an unquestionable proof of Don Borghi effect.

Also the antimony has shown a good activation. Its decay curve appears not much disturbed by the statistical fluctuations but the activation curve is less convincing.

The case of manganese

[A] ... a flux of epithermal neutrons, with energy $E > 10$ eV and a probable maximum between 50 and 300 eV. this upper limit is suggested by the fact that no activation is observed with Mn, which has a large resonance peak at 350 eV.

[D] This detector is not even cited in [B] version. This is the typical case in which the detector ought to be surrounded by a moderating sheath during the activation. The slowing down of the neutrons should have increased very much the measurement sensitivity. The Mn exists in nature only as the isotope 55, with a neutron thermal cross section of about 13 barn. The neutron capture forms ^{56}Mn , which emits beta particles and gamma-rays with energy of the order of MeV. Therefore the emission was observable with the used instruments.

However the complete procedure of the exposition is not referred, so the results cannot be quite acquired.

Activation of prometium, niobium and thallium

[D] Don Borghi attached importance to the prometium activation (as also of the partner niobium). The reason of such an interest is in the resonances the activation cross-section shows in the energy band of tens or hundreds eV, which could be the energy band of the emitted neutrons. The prometium decay was particularly regular.

These measures are not referred in [B], in which no hypothesis on the neutron energy is contained (in particular if they are, or not, epithermal).

^{204}Tl decays with a long half-life (3 y), so the Authors preferred don't follow its decrease. Instead an activation curve is presented, with measures which were repeated sometimes during an exposition lasted about a hundred days.

Use of thorium and uranium

[D] Nuclear reactions were also induced in naturally radioactive elements, as thorium and uranium.

Before and after exposition to neutrons, gamma measurements were made, with a little well scintillation detector (NaI). A clean modification of their radioactivity was observed, but the impossibility of energy determination prevented from deduce complete conclusions on nature of the effects.

Case of thorium

[A] [B] The activation of ^{232}Th samples, sealed in plastic tubes and in secular equilibrium with its family, has been repeatedly observed. One sample is conserved as control, and another has been irradiated for 13 days, showing an increasing gamma activity. From the initial 27750 cpm of both samples, the irradiated one reached to 43580, with a difference 16030. The activated sample has been retired and thereafter decayed toward a level 39300 cpm in 34 days.

The analysis of the decay suggests a principal contribution of ^{233}Pa ($T = 27$ days).

[D] The effect of the exposition is very clear, so the thorium measurement should have been the main point of the work of Don Borghi, which could be acknowledged as unquestionable by anyone.

By assuming the main effect was the (n, γ) reaction of ^{232}Th , the decay chain is:

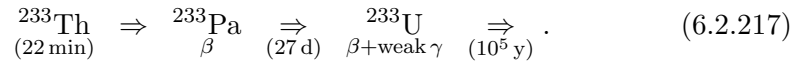

In spite of the already mentioned wrong evaluation of the statistical errors, the thorium measurement seems qualitatively indisputable.

Case of uranium

[B] For U we used cylinders of high density (10 g/cm^3). Its beginning gamma activity $142700 \pm 400 \text{ cpm}$ becomes 144860 ± 400 after some 3 hours of irradiation, and thereafter may be observed to decay to the starting value with a half life of about 30 min, probably due to short lived fission product, as suggested by the secondary maximum “delayed” of about 5 min... Indeed there are almost two observable periods, namely about 2 min and 30 min.

[D] It would sufficed to protract each measure for a longer time, in order to noticeably reduce the statistical errors, which importance here are increased by the little difference between the measures.

Despite the great statistical fluctuations, the use of uranium seems supply some valid indications. A gamma activity increases, and lather decreases, as due to a secondary radioisotope produced by neutrons not directly, but from decay of initial radioisotopes (perhaps beta emitter, not observed).

The half-life should be of some minutes, therefore it seems not belonging to the chain which lead to plutonium; rather it seems due to fission of ^{235}U . The Authors supposed the formation of ^{84}Se which decays in 3 min in ^{84}Br , which decays in 32 min.

CONCLUSIONS

Evaluation of the flux

[B] The so far unknown energy spectrum of these neutrons does the values of the (n, γ) cross sections uncertain. For them no certain flux calculation is allowed.

The activity increase of about $2000 \pm 500 \text{ c.p.m.}$ of the uranium, supposed at saturation, gives a flux ... hence 10^6 n/s .

[D] In order to obtain this rough evaluation, don Borghi takes advantage from the fact the macroscopic cross section is approximately constant ($\cong 1 \text{ cm}^{-1}$) for a large energy range. From the thorium results a very questionable calculation, present in [A] and [B] versions, takes to a similar flux value.

In spite of the many defects, not all slight, particularly in the data utilization, undoubtedly Borghi obtained clear radioactivation of thermal or resonance de-

tectors; it is therefore presumable that the cold plasma produced many neutrons (at least 10^4 n/s). The fact they produced many reactions also without having crossed any moderator suggests they were born with very low, near the thermal values, energy. This could exclude they be due to fusions between nuclei of hydrogen isotopes, for instance between the few deuterons present in the plasma.

Repetition of the experiment

[D] Those who will want repeat the Don Borghi experiment wouldn't be obliged to use all the detectors mentioned here. It will obligatory to have at disposal a low background beta counter and a good gamma spectrometer (with a large NaI crystal or solid state Ge detector).

The choice of the detectors will be made taking in account of the capture thermal cross-sections and of the half-life of the induced radioactivity. For very short times, dysprosium is preferable. For longer times indium and thorium are suitable. In gamma-ray spectrometry a good choice is a gold detector, with its half-life of 2.7 d and a lonely gamma. A further investigation should concern the walls of the cell, which may undergo alterations due to neutrons, or anyway due to nuclear reactions.

6.2.12.H Has the Don Borghi Experiment Been Secretly Redone?

As clear from the preceding analysis, Don Borghi's experiment is truly fundamental for all of physics, quite simple and rapid to rerun, and extremely inexpensive, particularly when compared to particle physics experiments preferred by academia. These aspects render implausible the idea that the experiment has never been rerun somewhere during the several decades since its original conduction.

In view of the above, there is an insistent view that the experiment has indeed been repeated by qualified laboratories. Since this view is voices by independent sources, it has sufficient plausibility for being reported here. The view here referred to is that:

1) The organized scientific crime ordered in the 1990s a U. S. nuclear physics laboratory to rerun Don Borghi experiment under the expectation that the results would be negative, hence good for immediate publication to discredit dissident views;

2) Unfortunately for said crime, the rerun confirmed Don Borghi's claim and, as such, the results could not possibly be released to the scientific community;

3) The organized scientific crime then ordered the repetition of the test to a British laboratory, and the experiment was conducted there under a fake name to cover up the real intent (the indicated fake title is "Studies of electric and magnetic polarization induced by an electric discharge in a hydrogen gas");

4) The results of the British rerun confirmed fully the U. S. tests and, therefore, the original Don Borghi's experiment;

5) Due to the enormous implications, the organized scientific crime brought the case to the attention of the Council of Foreign Relation and/or the organization known as "The New World order." A decision was reached at the top level of the crime to the effect that the results of these reruns had to be kept secret and supporters of Don Borghi experiment had to be continued to be discredited via the use of authoritative accomplices.

6.2.12.I How to Fake Don Borghi and/or Santilli Experiments

as indicated and documented in Appendix 6A, the maximal manifestation of organized scientific crimes occurs in experiments. In fact, various experiments have been commissioned for the studious intent to disprove tests indicating deviations from Einsteinian doctrines thanks to easy manipulations of data, introduction of meaningless parameters, fixing things and the like (see explicit calculations to that effect in Appendix 6A).

Due to the hardly believable ethical collapse of the physics community, experiments suggesting violations of Einsteinian doctrines suffer extreme obstructions in editorial reviews to prevent their publication (see next subsections), while counter-experiments commissioned by the organized scientific crime see their rapid publications in Physical Review Letters, Physics Letters, Journal of Physics, and other journals of the establishment.

It is then natural to expect that the international organized scientific crime will commission reruns of Don Borghi's and/or Santilli experiments for the specific, pre-set intent of manipulating the results to disprove the claims. In view of this expectation, it may be advantageous to both, serious as well as corrupt physicists, to indicate the following easy ways to manipulate said experiments:

1) In Santilli's klystron, the electric discharge can be made under a short with no gap between the electrodes, in which case no "entities" are produced and the occurrence can be used to "disprove Santilli experiment." In fact, for the "entities" to be produced, it is necessary to have a real electric arc within a hydrogen gas with at least 15-20 Kw causing at least a minimal gap of 2-3 mm for at least 4-5 s. When there is a short without gap, the electric current propagates through the electrodes with insignificant impact in the hydrogen gas. Hence, the serious scientist will make sure to have a real gap with a real arc within the hydrogen gas, while the corrupt physicists will make sure to fake a gap in order to "disprove the results."

2) Santilli's experiment can be repeated with minimal power (say of 1 Kw), the use of a hydrogen gas with minimal pressure (say, a fraction of one psi), creating a real arc with a real gap within the hydrogen gas, resulting in no detection of any type for 2-3 days, thus claiming the "disproof of Santilli experiment."

As indicated in the preceding section, the production of the "entities" and the rapidity of their detection are proportional to the power, the pressure of the hydrogen gas and other factors (recall that at 100 psi the production of the "entities" with 30 Kw EC-AC converter was so violent to cause the evacuation of the lab and the impossibility of repeating the test for safety). Hence, it is very easy to fake Santilli's experiment by reducing the power to an minimum to have an arc, reducing the pressure of the hydrogen gas, and limiting the time of the detections.

3) Santilli experiment can be repeated with the klystron insulated from external influence such as noise, vibrations, etc., resulting in no detection for days, thus claiming the "disproof of santilli experiment." As indicated in the preceding analysis, as well as in the references quoted therein, one or two days subsequent to the arc, Santilli had to shake the klystron with a rubber hammer to finally get detections of the "entities" outside the klystron, sometime occurring one or two weeks following the arc. Hence, the more the klystron is insulated from outside influence, the better Santilli experiment can be faked.

4) Santilli experiment can be easily repeated with various neutron detectors none of which is Li-activated, then "fix things" with a sufficiently low power and gas pressure, to end up with signals clearly not of neutron type, thus "disproving Santilli claims." It has been indicated in the preceding sections that, for reasons unknown at this writing, Lithium activation is, by far, the most sensitive to the "entities." Thus, Li-activated detectors can be studiously avoided to serve interests on Einstein. Additionally, it is very easy to select detectors solely sensing to gammas, rather than the "entities," thus reaching the preset aim of "disproving Santilli claims." The "entities" are not neutrons. Hence, it is easy to select detectors that are insensitive to the "entities;" the latter are then absorbed by the casing; resulting in sole gamma emissions. This is an excellent way to fake Santilli experiment because it allows the corrupt physicists to make the beloved claim that "no neutron has been produced in the test."

5) It is very easy to fake Santilli experiment via the mere use of the Tables of Nuclides. In fact, the transmuted nuclides caused by the absorption of the "entities" positively are not listed in the Table of Nuclides and, consequently, they do not exist. For the serious physicist we recall that the claim of production in Santilli experiment of true neutron, with consequential claims of activating conventional nuclides, is a direct admission of the continuous creation of matter in the universe. But then, the only possibility of avoiding such extreme implications is to admit that the "entities" are not neutrons, and, consequently, the activated nuclei are not listed in the Table of Nuclides.

6.2.13 Stimulated Decay of the Neutron

6.2.13.A The Dominant Factor in the Stimulated Decay of the Neutron: Ethical Decay in Physics

The neutron is *naturally unstable* (when isolated or part of certain nuclei). Moreover, depending on its nuclear environment, it exhibits a variety of meanlives from seconds all the way to thousands of years. Hence, it is quite plausible that the neutron admits one or more mechanisms called *triggers* (TR) capable of stimulating,



where β^- can be either conventionally interpreted as an electron and a neutrino, or as an electron and an antietherino. This alternative is irrelevant for the topic of this section and, consequently, it will be ignored.

We shall merely assume the conventional nuclear interpretation of β^- as carrying a negative charge, the conventional rest energy of the electron, and null spin due to antiparallel alignment of the electron and the neutrino/etherino (when the trigger has no spin). Other conventional interpretations of β^- , e.g., when carrying spin 1 due to parallel alignment of the electron and the neutrino/etherino, will be indicated when needed.

The systematic search for the possible stimulated decay of the neutron is an ethical duty of the physics community because, in case confirmed, it creates a new type of energy called by Santilli [125] *hadronic energy*, in the sense of originating from mechanisms in the interior of hadrons, rather than in their collection as typically the case for the *nuclear energy*.

Under a possible stimulated decay, the neutron would release a highly energetic electron that can be easily trapped with a metal shield thus producing heat, plus a possible difference of electric potential between the metal shield and the original material in the event the latter is a conductor (see below).

Besides new energies, the stimulated decay of the neutron would create a new technology, called *hadronic technology*, in the sense indicated above of being based on mechanisms inside hadrons. To our best knowledge, we are referring to the first conceivable possibility of practical applications of hadron physics, since the hadron physics of the 20-th century under the control of quark believers had positively none.

The biggest problem in the study of the possibility to stimulate the decay of the neutron is not the technical profile, since all tests in the field are very simple and immensely less expensive than particle experiments currently preferred at SLAC, FERMILAB, CERN, SACLAY, DESY, RUTHERFORD, JINR and other laboratories around the world.

The biggest problem is given by the widespread ethical decay in physics because, as it is the case for the neutron synthesis, the stimulated decay of the neutron is irreconcilably incompatible with Einsteinian doctrines and quantum

mechanics⁶¹ Consequently, organized academic, financial and ethnic interests on Einsteinian doctrines and quantum mechanics have perpetrated incredible ascientific, amoral and asocial acts of discrediting, jeopardizing and disrupting professional theoretical and experimental research in the field, as documented in this volume.

As it was the case for the laboratory synthesis of the neutron, the study of its stimulated decay without the joint addressing of issues pertaining to scientific ethics and accountability would be so hypocritical to be repugnant to this author.

Hence, the author feels an obligation of continuing the presentation of technical aspects while jointly denouncing organized scientific crimes in the field for judgment by our contemporary society, due to the pressing need for new energies, let alone a judgment by posterity.

Fortunately for society, the industry has responded to the need for new clean energies with investments in the stimulated decay of the neutron for the very reason that originates academic obstructions, *novelty*. However, industrial investments carry restrictions in disclosure because the abuse of academic authority would damage the investment, as desired by academia with due exceptions.

In fact, the author is conducting research under industrial contracts with various confidentiality restrictions. Hence, in this section we will be in a position of solely presenting information authorized for disclosure by the industry, namely, information that is old by industrial standards.

6.2.13.B The Main Hypothesis on the Neutron Stimulated Decay

The alternatives in the possible stimulated decay of the neutron are the following two:

ALTERNATIVE I: The constituents of the neutron are quarks conceived as physical particles in our spacetime.

In this case there is no possibility whatsoever, whether remove or conceivable, to stimulate the decay of the neutron, trivially, because the quarks are believed (but never rigorously proved) as being permanently confined inside the neutron. This is a reason political alignments on quark beliefs are considered a threat to society.

It should be clarified with clarity that physicists do have indeed the right to believe whatever they wish. Scientific crime occur when quark believers (currently in control pf the particle physics community) abuse their academic power to suppress, discredit and jeopardize alternative views.

⁶¹A variation of lifetime of the neutron would mandate the abandonment of the central pillar of special relativity, the Poincaré symmetry for broader vistas.

Ordinary crimes occur when quark believers continue to misuse public funds by ignoring, rather than disproving in refereed journals, the litany of inconsistencies for quarks to be physical particles published in refereed journals and reviewed earlier (lack of gravity due to lack of definition in our spacetime, absence of inertia, impossibility of a serious confinement due to Heisenberg uncertainty principle, etc.)⁶²

ALTERNATIVE II: The constituents of the neutron are particles permitting its synthesis, the proton and the electron.

In this case, the possibility to stimulate the decay of the neutron becomes plausible and quantitatively treatable, provided that one uses the covering hadronic mechanics evidently, because Alternative II is irreconcilably incompatible with quantum mechanics.

In fact, hadronic mechanics predicts various triggers for the stimulated decay (6.2.218) depending on whether acting in the structure of the neutron or in its nuclear environment, each case having various possibilities.

The biggest contributions of hadronic mechanics to the study of the neutron has been the achievement of a consistent representation of the electron as a physical constituent of the neutron, as well as the identification of its rest energy.

Said energy cannot be conventional, due to its immersion within the hyperdense medium inside the proton with consequential deviation from the Minkowskian spacetime experimentally verified in Section 6.1. Due to these mutations, in the transition from the spacetime of the vacuum to that within the hyperdense medium inside the proton, the electron experiences mutation (6,2,163b) of its rest energy we have called *isorenormalization*, i.e.,

$$E_e = 0.511 \text{ MeV} \rightarrow E_{\hat{e}} = 1.294 \text{ MeV}. \quad (6.2.219)$$

in which case the electron is called *isoelectron*.

An additional contribution of hadronic mechanics crucial for the task here at hand is that the isoelectron is essentially free at MeV scale, a feature called *hadronic freedom*

$$BE_{p-\hat{e}} \approx 0. \quad (6.220)$$

As assumed to be familiar by now, this is due to the fact that the force binding the un-mutated proton p and the mutated electron \hat{e} is of contact non-potential

⁶²As editor in chief of the *Hadronic Journal* and of other journals, Santilli has made it a point in accepting for publication papers on quark conjectures, even though he does not believe that quarks are physical particles. The understanding is that the *Hadronic Journal* has always been and will always be available for the publication of qualified alternative or dissident views. By comparison, the journals of the American Physical Society, the British Institute of Physics, and other physical societies solely publish papers on inconsistent, yet politically aligned quark theologies while rejecting qualified alternative or dissident views with motivations whose scientific credibility can only be qualified as being pathetic.

character, thus causing no binding energy, while the binding energy due to the Coulomb attraction is too small for the approximation here considered.

Since the neutron is naturally unstable, and its meanlife varies with its environment, Santilli proposed, apparently for the first time in Ref. [125] of 1994 (see review [126] of 1996), to *test the possible stimulated decay of the neutron via the use of photons γ_r with the resonating (r) energy (or frequency) of 1.294 MeV, plus expected adjustments for binding energies in nuclei:*

$$\gamma_r + (p^+, \hat{e}^-)_{hm} = \gamma_r + n \rightarrow p^+ + \beta^-, \quad (6.2.221)$$

where the "resonating photon" has the characteristic energy or frequency

$$\gamma_r = 1.294 \text{ MeV, or } 3.129 \times 10^{20} \text{ Hz,} \quad (6.2.222)$$

with harmonics

$$\gamma_r = (1.294 \times n) \text{ MeV or } (3.129 \times n) \times 10^{20} \text{ Hz,} \quad (6.2.223)$$

and subharmonics

$$\gamma = (1.294/n) \text{ MeV, or } (3.129/n) \times 10^{20} \text{ Hz, } n = 1, 2, 3, \dots \quad (6.2.224)$$

A second frequency of the resonating photon that should be taken into account is the standard characteristics frequency of the electron, that corresponding to the conventional value of its rest energy, namely,

$$\gamma_r = 0.511 \text{ MeV, or } 1.236 \times 10^{20} \text{ Hz.} \quad (6.2.225)$$

Another possibility to stimulated the decay of the neutron (we can disclose here because presented in Ref. [125]) is by using photons with a wavelength equal to the neutron size. In the former case, the aim is to excite the mutated electron inside the neutron, while in the latter case the objective is to excite the entire neutron. The expulsion of its structural electron and consequential decay is then expected from the above indicated hadronic freedom.

The reader should keep in mind that isorenormalization (6.2.219) depends on the density $b_4 = 1.65$ of the hadronic medium inside the proton, which value has allowed the exact representation of the energy, spin and magnetic moment anomalies of the neutron, and has been independently verified by the experiments on the Bose-Einstein correction of Section 6.1.10.

Note also that the "density" of hadrons has been studied by hadronic mechanics for the first time and completely ignored by orthodox particle physics because incompatible with Einsteinian doctrines. Hence, expecting final knowledge in first instance would be presumptuous (or politically motivated).

Consequently, the serious reader should accept value (6.2.222)-(6.2.224) as merely preliminary and in need of a number of corrections, some of which known,

and other possible. Among the known corrections, we mention the need to adjust value (2.1.222) for nuclear binding energies when dealing with neutrons as part of a nuclear structure.

Among other conceivable corrections, we mention the possibility that deeper studies on the structure of the neutron might identify a currently unknown, potential binding force between the proton and the electron significantly stronger than their Coulomb binding force, in which case value (6.2.222) must be corrected accordingly.

Stimulated decay (6.12.221) is impossible for quantum mechanics because the cross section of a photon with the neutron is so small to be ignorable at all energies. Hadronic mechanics does recover such a behavior, with the exception of the specific value of 1.294 MeV at which the cross section is predicted to have a typical resonating peak. This behavior requires the treatment via the *isoscattering theory* not treated so far in these volumes. Interested readers may consult Chapter XII of EHM, Volume II.

The case is similar to the discovery in the 1960s of the Λ particle at CERN. A group of physicists predicted a flat cross section and no new particle. Other physicists looked for novelty, predicted a resonating peak, looked for it, and found it.

Dismissals of tests of hypothesis (6.2.221) via the use of quantum mechanics are here denounced as a blatant scientific crime because quantum mechanics was conceived to describe point particles moving in vacuum, thus being inapplicable within the hyperdense medium inside the neutron. At any rate, quantum mechanics can only represent the neutron as a dimensionless point, while the neutron in reality is an extended object.⁶³

At any rate, hypothesis (6.2.221) is quantitatively predicted by hadronic mechanics from primitive axioms without adulterations and, independently from that, hypothesis (6.2.221) is plausible, thus requiring its *experimental* resolution as the only serious way to do science. Theoretical theologies in lieu of the experimental resolution are the way fanatic supporters of Einsteinian doctrines dreams of continuing to control the minds of researchers for their personal gains.⁶⁴

⁶³A basic characteristics of hadrons that is missing in the otherwise vast information released by the Particle Data Group is that of the *size* of hadrons. This absence is shocking since said size is so fundamental that no structure model can be considered credible unless it represents quantitatively said size, as it was historically the case for the hydrogen atom. The only credible explanation is that the indication of the size, that is, of the extended character of hadrons, would attract attention on the incompatibility *ab initio* of hadrons with Einsteinian doctrines and quantum mechanics, since the latter can solely represent particles as dimensionless points.

⁶⁴Einsteinian doctrines and quantum mechanics are assumed as being exact inside the neutron by the organized scientific crime via the abstraction of its interior to points, the selection of the constituents to forms that are compatible with the assumed theories, and the complete oblivion of catastrophic inconsistencies of such theologies identified before. Hence, the reason for the widespread fanatic belief in quark as physical particles can be understood only after the knowledge that quarks were introduced

It should be stressed that, by no means, the use of resonating photons is the only possibility to study the stimulated decay of the neutron, since numerous alternatives are possible (some of them being under industrial study and cannot be disclosed at this writing). Hence, the experimental issue is the study at large of *all* possibilities to stimulate the decay of the neutron, among which the use of resonating photons for the isoelectron and that for the neutron are only two among other possibilities.

Hence, any claim of the lack of stimulate the decay of the neutron following a possible insufficiency of numerical value (6.2.222) would be a scientific crime for personal gains.

6.2.13.C Proposed Tests for Stimulated Neutron Decays

In practical set ups, the stimulated decay of the neutron cannot possibly be tested for isolated neutrons as in reaction (6.2.221) but only when neutrons are members of a nuclear structure. Hence, the tests here considered deal with the *stimulated nuclear transmutations* of the type here written in terms of conventional nuclear specifications restricted for simplicity to atomic number A, nuclear charge Z and nuclear spin J [125]

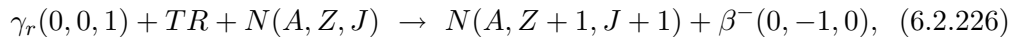

under the verification of all nuclear conservation laws and superselection rules, including the conservation of the energy, charge, angular momentum, parity, etc. Additionally, the resonating frequency has to be adjusted for nuclear binding forces of proved potential origin. Finally, in certain cases, the resonating photon alone may not be sufficient, thus requiring an additional trigger.

The mechanism here considered for stimulated decay (6.2.226) is elementary. The resonating photon hitting a nucleus is expected to excite a peripheral isoelectron irrespective of whether the photon penetrates or not inside the neutron. Once excited, there is no possibility for the isoelectron other than that of leaving the neutron structure, thus causing its stimulated decay.

This is due to the fact that hadronic mechanics predicts one and only one energy level for the neutron as a generalized bound state of the proton and the electron in conditions of total mutual immersion. The range of hadronic mechanics is essentially given by the radius of the neutron (1 *fm*). Once excited, the isoelectron has no other possibility than that of exiting the proton and reassuring its conventional quantum features for moving in vacuum.

as physical particles for the premeditated and studious intent of preserving the validity of Einsteinian doctrines and quantum mechanics inside hadrons.

Since in practical applications nuclei will not be hit by individual resonating photons, but by a coherent beam of the same, Santilli [125] also proposed the study of possible multiple stimulated decays of peripheral neutrons in a nucleus

$$n \times \gamma_r(0, 0, 1) + N(A, Z, J, 0) \rightarrow N(A, Z + n, J + n) + n \times \beta^-(0, 01, 0), \quad (6.2.227)$$

where $n = 1, 2, 3, \dots$

The first example suggested by Santilli for test is given by the following use of a photon with the needed resonating frequency without any trigger [125]

$$\gamma_r(0, 0, -1, 0) + Li(6, 3, 1) \rightarrow Be(6, 4, 0) + \beta^-(0, -1, 0), \quad (6.2.228a)$$

$$Be(6, 4, 0) \rightarrow He(4, 2, 0) + 2 \times p(0, +1, 1/2), \quad (6.2.228b)$$

where, by using the data in the Table of Nuclides (<http://atom.kaeri.re.kr/>): $Li(6, 3, 1)$ is naturally stable with mass $6.0151223 u$; $Be(6, 4, 0)$ has the mass of $6.0197258 u$, it is naturally unstable and decays in 5 days as shown; and $He(4, 2, 0)$ is stable.

Note that, for reactions (6.2.228) to take place, it is necessary that the resonating photon and the Lithium have opposite spin polarization (indicated with $J = -1$). Also, $Li(6, 2, 0)$ is *lighter* than $Be(6, 3, 0)$,

$$\begin{aligned} M(6, 3) - M(6, 4) &= 6.0151223 - 6.0197258 u = \\ &= -0.0046035 u = -4, 28813276 MeV. \end{aligned} \quad (6.2.229)$$

Hence, the above stimulated nuclear transmutations require a resonating frequency with the minimum energy of $6.258 MeV$ corresponding to values (6.2.223) for $n = 2$.

Another example of stimulated decay of the neutron suggested for tests is given by the isotope $Zn(70, 30, 0)$ for which we have the predicted reactions [125]

$$\gamma - r(0, 0, 1, 0) + Zn(70, 30, 0) \rightarrow Ga(70, 31, 1) + \beta_1^-(0, -1, 0), \quad (6.2.230a)$$

$$Ga(70, 31, 1) \rightarrow Ge(70, 32, 1) + \beta_2^-(0, -1, 0), \quad (6.2.230b)$$

where, by using data from the Table of Nuclides, we have

- 1) $Zn(70, 30, 0)$ has the mass of $69.9253249 u$ and it is stable;
- 2) $Ga(70, 31, 1)$ has the mass of $69.9260277 u$, is naturally unstable and decays into $Ge(70, 32, 1)$ with half life is of $21.14 min$;
- 3) $Ge(70, 32, 0)$ has the mass of $69.9242504 u$ and is stable.

As one can see, the mass of $Zn(70, 30, 0)$ is *smaller* than that of $Ga(70, 31, 1)$, with negative energy difference

$$M(70, 30) - M(70, 31) = -0.0007028u = -0.65465MeV. \quad (6.2.231)$$

Consequently, stimulated nuclear transmutations (6.2.130) are possible if and only if the resonating photon has an energy bigger than 0.654 MeV , since all other conservation laws and superselection rules are verified.

This condition can be easily verified with resonating energy (6.2.224) with minimum value of $n = 1/4$ corresponding to 0.782 MeV (ignoring corrections due to binding energy for simplicity).

Note that the difference between the mass of the initial and final isotope is positive,

$$M(70, 30) - M(70, 32) = 0.0010745u = 1.00089033 \text{ MeV}. \quad (6.2.232)$$

Hence, under the minimal resonating energy of 0.782 MeV , stimulated nuclear reactions (6.2.230) have the *positive* energy output

$$M(70, 30) - M(70, 32) - E(\gamma_r) = 0.218 \text{ MeV}. \quad (6.2.233)$$

Another example suggested for tests is given by

$$\gamma_r(0, 0, 1, 0) + S(32, 16, 0) \rightarrow Cl(32, 17, 1) + \beta^-(0, -1, 0), \quad (6.2.234a)$$

$$Cl(32, 17, 1) + EC \rightarrow \alpha + Si(28). \quad (6.2.234b)$$

where: $S(32, 16, 0)$ has the mass of $31.9720707 u$; $Cl(32, 17, 1)$ has mass $31.9856889 u$, is naturally unstable and decays as shown in 298 ms . Again, the mass of S is smaller than that of Cl . Nevertheless, the stimulated decay of the neutron is possible by selecting a suitable resonating frequency as for the cases above.

Note that there are numerous possible selections of similar reactions, not only for the case of one but also for double or triple stimulated decays per nucleus, that cannot possibly be studied at this time, and are left to the young minds of any age.

Additionally, it should be stressed that proposal [125] is old by current industrial standards and a number of additional possibilities are under investigation by the industry. This is the reason we denounce as scientific crime any dismissal of the stimulated decay of the neutron solely based on old theoretical theologies without systematic *experimental* studies.

Finally, it should be stressed that *the stimulated decay of the neutron recommended for test is not for isolated neutrons, but within the context of "nuclei."* *But the synthesis of the neutron here considered has generated a dramatic revision of nuclear structures studied in the next section. Hence, any posturing of judgments on the proposed stimulated decay prior to an in depth study of the new vistas in nuclear structures is vulgar scientific corruption by immoral outcasts.*

6.2.13.D Classification of Hadronic Energies

We are finally equipped to introduce the main objective for which hadronic mechanics was built for, the conception and quantitative treatment of basically

new energies. They were first indicated in the original proposal [14] of 1978, treated in detail in Ref. [125] of 1994 and further developed in monograph [99] of 1998:IndexClassification hadronic energies

DEFINITION 6.2.1: Hadronic energies are all forms of energies that cannot be predicted via quantum mechanics, but can be predicted and quantitatively treatable via the covering hadronic mechanics, and can be classified as follow:

CLASS I, when occurring at the level of individual hadrons;

CLASS II: when occurring at the level of nuclei; and

CLASS III; when occurring at the level of atoms or molecules.

In this section we shall consider one example of hadronic energies of Class I. Those of Class II will be considered in section 6.3 of this volume and those of Class III will be considered in Chapter 11 of Volume V.

6.2.13.E Examples of Hadronic Energies of Class I

Example of Hadronic Energies of Class I were submitted in Ref. [125] via the following stimulated decays,

$$n \times \gamma_r(0, 0, 1) + TR + N(A, Z, J) \rightarrow N(A, Z + n, J + m) + n \times \beta^-(0, -1, 0), \quad (6.2.235a)$$

$$N(A, Z + n, J + m) \rightarrow N(A, Z + 2, J + m) + \beta^-(0, -1, 0), \quad (6.2.235b)$$

$$N(A, Z + 1, J + m) \rightarrow ?, \quad (6.2.235c)$$

where: the first reaction is stimulated and the others are spontaneous; and the spin of $N(A, Z + 2, J + m)$ is not assumed to be necessarily $J + n$ due to possible opposing polarizations and other effects.

The original isotope should be selected in such a way to meet the following conditions:

1) The original isotope admits the stimulated transmutation while verifying all conservation laws of the energy, angular momentum, etc.;

2) The resulting isotope admits a spontaneous β decay so that with one resonating photon we have the production of two electrons whose kinetic energy is trapped with a metal shield to produce heat;

3) The original isotope is selected to be a metal so that, following the emission of two electrons, it acquires an electric charge suitable for the production of a DC current between the metal isotope and the metal shield;

4) The energy balance is positive; and, last but not least

5) The initial and final isotopes are light, natural and stable elements so as to have a new energy that is *clean* in the sense of producing no harmful radiations (since the electrons can be easily trapped with a thin metal shield), and leave no radioactive waste.

When the above conditions are met, the original isotope is called *hadronic fuel* and the equipment used for its realization is called *hadronic reactor* [125]. It

should be stressed that, in accordance with Definition 6.2.1, the word "hadronic" is not referred to strongly interacting particles, but intended to emphasize the need of hadronic mechanics for quantitative studies.

Ref. [125] then suggested the concrete case for testing the existence of Hadronic Energies of Class I based on the isotope $Mo(100, 42, 0)$, reproduced here as originally proposed, namely, without the trigger developed subsequently, because unavailable in 1994,

$$\gamma_r(0, 0, 1) + Mo(100, 42, 0) \rightarrow Tc(100, 43, 1) + \beta^-(0, -1, 0), \quad (6.2.236a)$$

$$Tc(100, 43, 1) \rightarrow Ru(100, 44, 0) + \beta^-(0, -1, 1), \quad (6.2.236b)$$

where, by using again the data from the Table of Nuclides, we have:

- 1) $Mo(100, 42, 0)$ has the with mass of 99.9074771 u and it is stable;
- 2) $Tc(100, 43, 1)$ has a mass of 99.9076576 u and is naturally unstable with half life of 15.8 s and sole decaying mode into $Ru(100, 44, 0)$;
- 3) $Ru(100, 44, 0)$ has themass of 99.9042197 u and it is stable.

As one can see, the mass of $Mo(100, 42, 0)$ is *smaller* than that of $Tc(100, 43, 1)$,

$$M(011, 42) - M(100, 43) = 0.0001805u = 0.16803 \text{ MeV}. \quad (6.2.237)$$

Yet it can be verified with the minimal subharmonic resonating energy (6.2.224) for $n = 7$ (again, ignoring correctsions due to binding energies)

$$E(\gamma_r) = 0.1848 \text{ MeV}. \quad (6.2.238)$$

But the mass of the original isotope is *bigger* than that of the final isotope,

$$M(100, 42) - M(100, 44) = 0.0032574 \text{ u} = 3.03424865 \text{ MeV}, \quad (6.2.239)$$

thus resulting in a positive energy output.

Hence, stimulated nuclear transmutation (6.2.236) verifies all nuclear conser-
vation laws, while the energy output is bigger than the resonating energy, the
case thus qualifying as an example of hadronic energy (HE) of Class I, with total
energy output per reaction

$$\begin{aligned} HE &= M(100, 42) - M(100, 44) - E(\gamma_r) - 2 \times E(e) = \\ &= 3.034 - 0.184 - 1.022 \text{ MeV} = 1.828 \text{ MeV}, \end{aligned} \quad (6.2.240)$$

where we have subtracted the conventional rest energy of the two electrons be-
cause not usable as a source of energy in this case.

The predicted hadronic energy in this case is *two-fold*, because we first have
the production of it heat acquired by the shield capturing the electrons and,
jointly, we have the production of a DC *electric current* between the metal isotope
 $Mo(100, 42, 0)$ acquiring a positive charge due to the loss of two electrons per

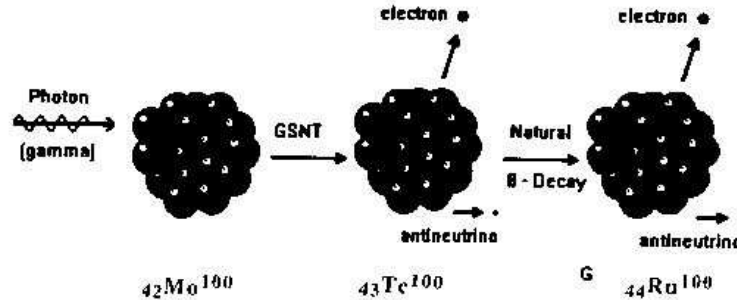

Figure 6.34. A schematic view of the proposal of Ref. [125]: use a coherent beam of resonating photons to stimulate the transmutation of the isotope $Mo(100,42)$ into $Tc(100,43)$ with the emission of a first highly energetic electron, followed by the spontaneous decay of $Tc(100,43)$ into $Ru(100,44)$ with the emission of a second highly energetic electron, the mass of $Mo(100,42)$ being sufficiently bigger than the mass of $Ru(100,44)$ to allow a positive energy output after subtracting the energy of the resonating photons, while verifying all remaining nuclear laws.

reaction, and the metal shield acquiring two negative charges, by keeping into account that each resonating photon produces two electrons.

To appraise the usable energy, let us recall the following units and their conversions

$$1 u = 931.494 \text{ MeV}; \quad 1 \text{ MeV} = 1.602 \times 10^{-13} \text{ J} = 4.45 \times 10^{-17} \text{ Wh} =$$

$$= 1.511 \times 10^{-16} \text{ BTU}; \quad 1 \text{ Wh} = 3.397 \text{ BTU}; \quad (6.2.241a)$$

$$1 \text{ C} = 6.241 \times 10^{18} e; \quad , 1 \text{ A} = 1 \text{ C}/1 \text{ s}, \quad (6.2.241b)$$

where e is the elementary charge of the electron.

Then, as an illustration, under the assumptions of using a coherent beam with resonating photons hitting a sufficient mass of $Mo(100,42,0)$ suitable to produce 10^{20} stimulated nuclear transmutations (6.2.236) per our, we have the following (see the figure):

Hadronic production of heat;

$$2 \times 10^{20} \text{ MeV}/h = 3 \times 10^4 \text{ BTU}/h, \quad (6.2.242)$$

Hadronic production of electricity:

$$2 \times 10^{20} e/h = 200 \text{ C}/h = 55 \text{ mA}. \quad (6.2.243)$$

A few comments are now in order. We have presented an example of Hadronic Energy of Class I in its original formulation of Ref. [125] with the sole

addition of clarifications to show its plausibility, but without any addition of the industrial knowledge achieved since 1994. This has been necessary to prevent the usual non-technical attacks by academia toward novelty with evident damage to environmental research.

Evidently, the output of heat and electricity of the above proposal is moderate. Nevertheless, the use of $Mo(100, 42, 0)$ is a mere indication out of a predicted number of possibilities with heavier isotopes and expected bigger production of heat and electricity, particularly under the use of an appropriate additional trigger.

Despite these shortcomings, *the example of hadronic energy here considered does indeed illustrate the possibility of reaching, in due time, a new form of nuclear energy without the release of harmful radiations and without leaving radioactive waste.* In fact, the electrons are not considered harmful radiations, while both the original and final isotope are light, natural, and stable elements.

In the event the objective is the production of large amounts of energy, it is necessary to consider heavy nuclei and more suitable triggers. As a working hypothesis among many, we suggest for study the possibility of using *a coherent beam of resonating photons to transmute $U(235, 92, 7/2)$ or other heavy nuclei into isotopes admitting spontaneous fission but without the emission of neutrons, a possibility evidently without military relevance, but of clear environmental value.* The chain reaction can then be maintained by continuing to use the beam of resonating photons as well as the trigger.

The latter possibilities are the target of academic obstructions and disruptions due to their novelty. Additionally, the equipment for their safe test is not available in most corporate laboratories. Hence, Santilli has elected to ignore them.

At this point we would like to make a comparison between the first nuclear energy, that predicted by the Italian physicist Enrico Fermi at the University of Rome, Italy, in the 1930s, and the new energy proposed by another Italian physicist, Ruggero Maria Santilli.

Fermi was forced to work with the theoretical knowledge and technologies of the 1930s essentially consisting of quantum mechanics and the use of neutrons to stimulate *nuclear fission*. This resulted in a form of energy, that was indeed historical at the time of its conception, but which is today considered environmentally insufficient due to the production of harmful radiations and the release of radioactive waste. Note that these features are inherent in the selection of *heavy nuclei*.

Santilli uses the much more advanced theoretical knowledge of the 21-st century, as well as a variety of new technologies not available during Fermi's times. These new conditions have permitted Santilli to search for new forms of nuclear energies originating from *light nuclei*, since in the latter case there is no sufficient energy to produce harmful radiation or to leave dangerous waste.

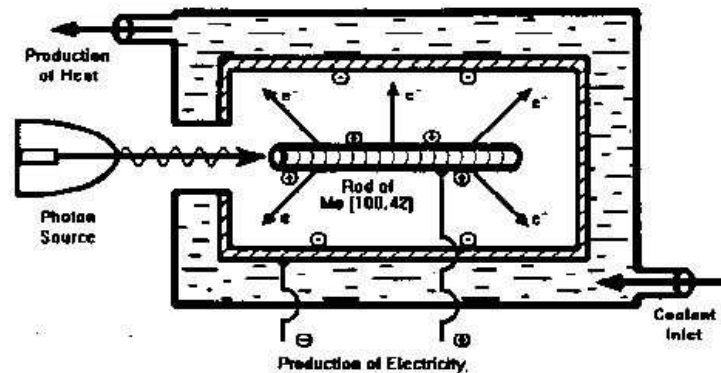

Figure 6.35. A conceptual view of the Hadronic Energy of Class I proposed for test in Ref. [125] of 1994. A coherent beam of photons with the needed resonating frequency (on the left) hits a cylindrical rod of $Mo(10, 42)$ (in the center), with stimulated nuclear transmutations (6.2.236). The proposal predicts the production of two highly energetic electrons per each resonating photon that are trapped via a metal shield, thus producing heat usable via an exchanger. Since $Mo(10, 42)$ is a conductor, there is the prediction of a second source of energy given by a DC current between the shield and the $Mo(100, 42)$. Note that the energy of the photons not causing nuclear transmutations (6.2.236) is not lost because it becomes part of the heat produced. Note finally that the efficiency of nuclear transmutations (6.2.236) can be enhanced via suitable triggers in addition to the resonating frequency and that the use of suitably isotopes heavier than $Mo(100, 42)$ would produce bigger energies.

The biggest difference between Fermi's and Santilli's times is, however, the collapse of scientific ethics in academia occurred since the 1930s. This ethical collapse is the primary origin for the lack of solution until now of our alarming environmental problems, the need of surpassing Einsteinian doctrines and quantum mechanics, e.g., via irreversible coverings to achieve a credible representation of notoriously irreversible energy releasing processes, while organized interests in academia strongly opposes the establishing of said covering theories.

In fact, Fermi's rudimentary ideas met with a very receptive, cooperative and supportive scientific environment in the USA, and the rest is well known history. By comparison, Santilli has met to this writing (February 2008) incredible oppositions, obstructions and disruptions in theoretical, let alone experimental studies of possible new energies, as documented beyond "credible" doubt in Refs. [89,90] and in the footnotes of this volume.⁶⁵

⁶⁵A routine posturing by a number of (but not all) academicians exposed to the need for supporting the study of "new" energies of the type presented in this section, is that "the proposal is not properly developed in a form suitable for tests." The corrupt character of the posturing is soon exposed by noting that, by applying the same rule, when exposed to the rudimentary idea Enrico Fermi brought from Italy,

It is hoped receptive readers (as well as academicians) in good faith who care about science and the future of their own children understand the necessity of denouncing these obstructions as *organized scientific crimes* because clearly damaging the human society, since they manifestly damage the study of much needed new clean energies.

6.2.14 Tsagas experiment on the Stimulated Neutron Decay

The experimental verification of stimulated nuclear transmutation (6.2.236) was initiated by N. Tsagas and his group [127] at the Nuclear Engineering Department of the University of Thrace, Xanthi, Greece, with preliminary, yet positive results.

The test was conducted in the following way: 1) using a disk of $Eu(152, 63, 3)$ as the source of resonating photons (see again the Table of nuclides <http://atom.kaeri.re.kr/>); 2) placing said disk next to a disk of *natural* Molybdenum as target; and 3) measuring the background without any source, the emission with the Europa source alone, and the emission with the joint disks of Europa and natural Molybdenum.

Electrons originating from the Compton scattering of photons with peripheral atomic electrons can at most have 1 MeV energy, as well known. Therefore, the detection of electrons with energy over 2 MeV establishes their nuclear origin.

Since the Europa source does not emit electrons, and the Molybdenum is stable, the only possible origin of emitted electrons is due to the stimulated decay of neutrons inside the Molybdenum disk. As recalled earlier, the first reaction (6.2.236a) emits electrons with minimal energy of 2.8 MeV , while the second reaction emits electrons with energy ranging from 2.22 MeV to 3.38 MeV .

It should be indicated that Tsagas's test [127] is limited because:

A) the tests used ordinary Molybdenum, that contains the isotope $Mo(100, 42, 0)$ only in 0.6 %, while all the remaining, rather numerous stable isotopes of the Molybdenum cannot admit the stimulated decay here considered for various reasons (see the preceding subsection).

B) The primary frequency emitted by the selected radioisotope, 1.874 MeV , is *not* the resonating frequency that should instead be 1.294 MeV less the adjustment due to the nuclear binding energy, although $Eu(152, 63, 3)$ does emit a number of additional photons, one of which has the energy of 0.148 MeV close to the subharmonic of the resonating energy.

C) The tests solely used detectors of the *energy* of the emitted particle, without additional detectors for the identification of their nature.

the President of the University of Chicago should have told Fermi "You must first build a prototype of your nuclear reactor and then I will hire you."

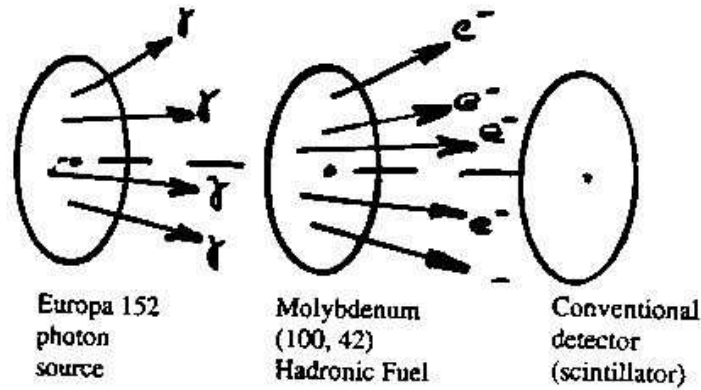

Figure 6.36. A schematic view of the first experimental verification of the stimulated decay of the neutron performed by N. Tsagas et al. [127], illustrating: the source of resonating photons (a disk of $Eu(152, 63, 3)$); the hadronic fuel selected for the test (a disk of natural Molybdenum) placed next to the Europa disk; and a scintillator capable of measuring the energy of the emitted electrons. Measurements of electrons with energy sufficiently bigger than 1 MeV establish the existence of the stimulated decay of the neutron beyond "credible" doubt because these electrons cannot be emitted by the indicated elements and cannot be of Compton origin, thus solely originating from a stimulated neutron decay.

Under these conditions, the possibilities of achieving reaction (6.2.236) are then rather limited. Yet Tsagas did indeed report the detection of emissions in the sole $Eu-Mo$ coupling in excess of 1 MeV , as shown in Figure 6.37, which unexpected occurrence renders Tsagas experiment even more interesting and meaningful, particularly in connection with the new vista on nuclear structures mandated by the structure of the neutron as a bound state of a proton and an electron of Section 6.3.

6.2.15 Santilli Experiment on the Stimulated Neutron Decay

Following Tsagas experiment [127] of 1996, Santilli proposed its repetition to numerous nuclear physics laboratories around the world, with the same results as those of the proposed experiments on the neutron synthesis, namely, obstructions and disruptions.⁶⁶

⁶⁶As an illustration, the editors of *Physics Review Letters* rejected a proposal to do the tests on grounds that "The author ignores the advances occurred during the past fifty years," which advances evidently refer to quark theologies without gravity inertia or confinement, neutrino beliefs with a chain of unverifiable conjectures each one in the scheme of supporting a preceding inconsistent conjectures and similar manipulation of knowledge for personal gains extremely disconnected from the quoted "knowledge."

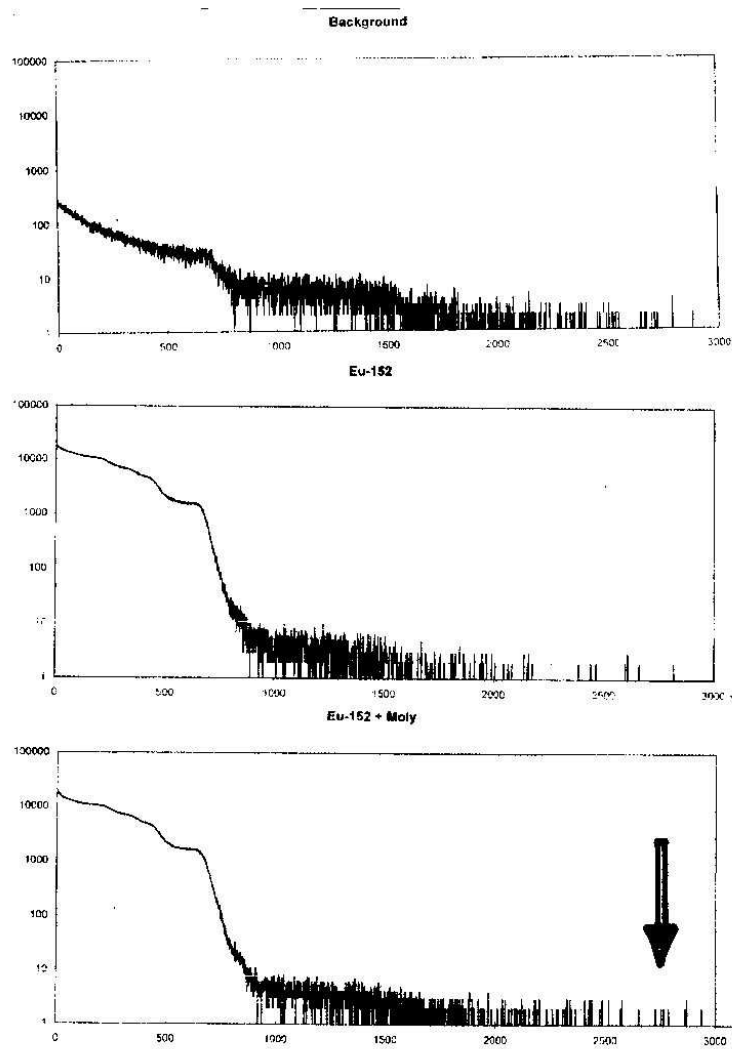

Figure 6.37. A reproduction of preliminary measurements by N. F. Tsagas and his team (private communication following ref. [127]) on the test of Santilli's hadronic energy of Class I via the model of Figure 6.36. The top view shows the background without any disk. The middle view shows the emission spectrum of Europa. The bottom view shows the emission spectrum of the coupled Europa and Molybdenum disks, with the clear presence of additional emissions with energy over 2 MeV , apparently confirming stimulated beta decay (6.2.236), of course, in a preliminary way.

Due to the extreme conceptual, epistemological, mathematical, theoretical and experimental relevance of the needed tests, Santilli had no other alternative than that of repeating the test at the Laboratory of the Institute for Basic Research in Florida.

Santilli's experiment was done: 1) Via the use of a pure isotope of $Mo(100, 42, 0)$; 2) the use of radioactive isotopes having the correct resonating frequency; 3) The use of energy measuring detectors; 4) The use of additional particle detectors; and 5) Conducting the test with and without additional triggers besides the resonating frequency.

Regrettably, as of today (March 10, 2008) Santilli has not received authorization by the industry providing all financial support to disclose details and results due to the ongoing collapse of ethics in academia.

6.2.16 Application to the Stimulated Decay of Radioactive Nuclear Waste

There is little doubt that the highly radioactive nuclear waste accumulating in our nuclear power plants is one of the biggest unsolved problems of contemporary society (for an outstanding review, one should consult J. Dunning-Davies [100]).

In the U.S. alone we have over 150,000 tons of radioactive waste currently stored at nuclear power plants. We have, therefore, surpassed the limits for safe storage in the pools of nuclear power plants. Europe has an even bigger tonnage of nuclear waste, and an unknown amount exists in other countries, all waiting for a serious addressing and a successful resolution. The yearly world production of about 30,000 tons of additional waste then sets the premises for a truly serious environmental problem of potentially historic proportions.

As it is well known, the official position by the U.S., European and other governments has been that of transporting the highly radioactive nuclear waste to a dumping area. This "solution" has met with predictable resistance from environmental groups and residents near the proposed dumping grounds.

In fact, the transportation of the nuclear waste must occur on public streets, with evident dangers nobody can credibly deny. Assuming that local residents will permit the transit of such dangerous a material and in such a large amount, additional potentially catastrophic dangers exist in the intended storage of the nuclear waste, because it cannot be credibly predicted to be viable for tens of thousands of years.

This scenario has led to the current lack in the U. S. as well as abroad of a credible solution for the disposal of the highly radioactive nuclear waste.

After studying the problem for several years, Santilli proposed [128] (see also Ref. [129,130]) the *conduction of systematic studies on the recycling of highly radioactive nuclear waste via its stimulated decay in the pools of the nuclear power*

plants themselves, so as to avoid its transportation altogether, as well as render nuclear power much more environmentally friendly.

In fact, the use of recent technologies allows the production of beams of coherent photons of the desired resonating energy with an equipment of moderate size, fully usable in nuclear power plants. Additionally, the new means for recycling nuclear waste are expected to create a new industry, that for the development, production and sale of the new equipment, that is expected to be needed by nuclear power plants all over the world.

Since the nuclei here considered are *very large and naturally unstable*, they are expected to admit a variety of means to stimulate their decay (rather than wait for their natural decay). Some of them are of Class II, namely, of nuclear character, that is, acting on the waste nuclei as a whole. These means will be considered in Section 6.3. In this section we consider means of Class I, namely, based on process occurring in the interior of the nuclear constituents.

The proposed recycling nuclear waste via the stimulated decay of the neutron consists of exposing the radioactive nuclear waste to an intense and coherent beam of photons with the needed resonating frequency, that can be obtained from a synchrotron of a few meters in diameter, or other equipment.

Under a certain intensity and other conditions, various peripheral neutrons of the nuclei are predicted to decay simultaneously, thus creating an *instantaneous excess of protons*, under which the stimulated decay is consequential, due to the extreme instability of these large nuclei.

On merely indicative grounds, consider the isotope $U(238, 92)$ of the waste released by nuclear power plants, that has the very long life of 4.51×10^4 years with the known harmful fission and the emission of alpha particles and other debris.

The use of the technology under consideration would imply the single stimulated transmutation (121)



where $Np(238, 93)$, which is also unstable, but with meanlife of 2.1 days, should itself be subjected to stimulated decay.

The double stimulated transmutations would yield

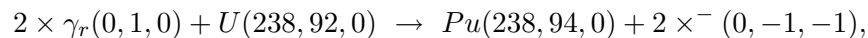

where $Pu(238, 94, 0)$, that is also unstable, should be subjected to stimulated decay until all unstable nuclei have experienced fission.

Possible tertiary artificial transmutations would yield $Am(238, 95)$ that is unstable with meanlife of 1.9 hours, spontaneous electron capture back to $Pu(238, 94)$ and emission of 2.3 MeV.

Needless to say, the objective is the recycling of nuclear waste and *not* the production of energy that, in any case, is plenty available in nuclear power plants. Hence, the possible release of energy in the above stimulated decays is irrelevant.

It should be stressed that Santilli's proposal [128] is the conduction of "comprehensive studies" in the stimulated decay of radioactive nuclear waste, because any expectation of quick solutions with little funds is either naive or corrupt, due to the dimension of the problem.

Also, the solution is not expected to originate from one single method, since it will require the combination of various methods, several of which have been already proposed and some of them patented (see Ref. [129] for brevity).

In closing it should be indicated that **Santilli has elected not to conduct any additional research in the stimulated nuclear decay because of threats not only to himself, but also to other scientists who tried to work in the field, some of them losing their job in the process.**

To give an idea of the organized scientific crime in the field, the reader in good faith should be aware that Santilli and his wife Carla organized some 18 international meetings in three continents. In 1998 they decided to organize a World Congress on Recycling Nuclear Waste to gather all the best scientists in the field and identify the needed research.

For that purpose the Santillis did set up the Scientific Committee one can see in web site [130] and attempted to organize the conference at the Nuclear Physics Department of the University of Florida in Gainesville. Rather than assisting in the organization of a conference with such a transparent societal and environmental relevance, the outcome was such to discourage any additional attempt at organizing the conference anywhere in the USA, outcome that included the loss of a permanent job by a leading member of the Scientific Committee at a leading national laboratory.

Then, the Santilli attempted the organization of the same meeting in Europe by contacting the director of the time of the appropriate branch of the European Community in Bruxelles, C. Routti director of the EC XIi Division. Routti's behavior was so repulsive and obstructive to prevent any attempt at organizing the conference anywhere in Europe.

The announcement of the **World Congress on Recycling Nuclear waste** for the year 2000 has been left in the web site [130] as a documentation of the the fact that the lack of solution of the increasingly alarming environmental problems is due to a world wide collapse of ethics.

6.2.17 Hadronic Structure Model of Baryons with Physical Constituents

In preparation

6.2.18 Compatibility of the Hadronic Structure Models with SU(3)-Color Classifications

In preparation

6.2.19 Hadronic Structure Model of Mesons with Physical Constituents

In preparation

6.2.20 Hadronic Structure Model of Baryons with Physical Constituents

In preparation

6.2.21 Compatibility of the Hadronic Structure Models with SU(3)-Color Classifications

In preparation

6.3 EXPERIMENTAL VERIFICATIONS AND APPLICATIONS IN NUCLEAR PHYSICS

6.3.1 Introduction

The achievement in the preceding chapter of an axiomatically consistent and time invariant representation of all characteristics of the neutron as a hadronic bound state of a proton and an electron, establishes that *nuclei are constituted by protons and electrons, the 20-th century view of being constituted by protons and neutrons being a mere first approximation.*

Serious scientists, politicians, educators and philosophers alike should never forget that stars initiate their life as being solely formed by hydrogen, that is, by protons and electrons, and that the protons and the electrons are the only known, massive, permanently stable particles. The posturing for over one century has been that the protons and the electrons "disappear" in nuclear syntheses and are replaced by neutrons for the studious adaptation of nature to preferred doctrines. Such a posturing is *de facto* scientific corruption for personal gains, because serious science requires the opposite, namely, the adaptation of the doctrines to physical evidence.

Similarly, it has been established in Section 6.2 that quantum mechanics cannot be exactly applicable to the simplest possible nuclear synthesis, that of the neutron. But then, any belief that quantum mechanics is exactly valid for more complex nuclear synthesis is sheer scientific corruption so damaging to science, particularly when proffered by experts, that must be denounced as such.

On theoretical grounds, the emerging new conception of nuclei permits the resolution of problems in nuclear physics that, having remained unsolved in over one century following the use of a river of public money, are nowadays simply embarrassing (to use an euphemism). In fact, the new conception of nuclei allows the first achievement of an invariant representation of *all* characteristics of the deuteron that, as denounced in Chapter 1, escaped resolution throughout the entire 20-th century.

On industrial grounds, the emerging new views on the structure of nuclei opens, by itself, virtually unlimited possibilities for new clean energies of direct social relevance, without known military applications (because occurring new light nuclei rather than heavy ones).

IN PREPARATION - NOVEMBER 1, 2005

For a summary of the content of this chapter, consult

The Physics of New Clean Energies and Fuels According to Hadronic Mechanics, R. M. Santilli, Special issue of the Journal of New Energy, 318 pages (1998).
See also www.neutronstructure.org

Foundations of Hadronic Chemistry with Applications to New Clean Energies and Fuels, R. M. Santilli, Kluwer Academic Publishers, Boston-Dordrecht-London (2001).

Isodual Theory of Antimatter with Applications to Antigravity, Grand Unification and Cosmology, R. M. Santilli, Springer (in press)

Appendix 6.A

Ethical Problems in Particle Experiments

Only the most corrupt of a scientist can deny the existence of serious ethical problems in contemporary physics. The situation is so serious and the consequences are so grave, that *our contemporary society can be compared to the condition of the Roman empire prior to setting of Roman laws, because of basic insufficiencies of existing laws to address scientific crimes.*

Recall the Roman original definition of "crime" as damage to society. It is then evident that the manipulation by a physicist of scientific knowledge for personal gains causes damage to society dramatically bigger than ordinary crimes, such as a gun point stealing of money at a grocery store. The insufficiencies of current laws are then clearly established by the fact that the latter crime can indeed be punished with jail sentences, while the former is fully permitted despite its much more serious character.

The above view is not capricious, but based on personal experience. In fact, during the various personal attempts by the author to contain scientific corruptions, plagiarisms, frauds and other scientific crimes, judges and attorneys alike could not even understand the author's claims, let alone properly act on them in the protection of society (see <http://www.scientificethics.org>).

Exactly as it was the case for the Roman society over two millennia ago, our contemporary society will not enter into an era of great discoveries, capable of unthinkable advances, all the way to bring mankind to the stars (Section 6.1.3), until scientists, educators, economists, industrialists and politicians understand the need for, and implement *a new code of laws* encompassing also the control of scientific crimes.

In the Preface of this volume we indicated that the easiest manipulations of scientific knowledge occur in contemporary experiments because:

- 1) Manipulations of data to verify a preset theory are quite easy due to the complexity of the elaborations themselves;
- 2) The experimental data are generally elaborated via the very theory intended for verification, as a consequence of which, the "experimental results" must be compatible with the pre-set assumptions;
- 3) Very few events are often selected out of hundred of millions of events (as it is the case for the claimed "neutrino detection"), and then use of academic power to claim a pre-set result.

A dark shadow in the science history of the U. S. A. is the claim in 1995 by FERMILAB of the "discovery of the top quark" via its CDF and CO experiments with the additional claim to have "measured its mass" (174.2 GeV corresponding to the mass of a nucleus) [84]. In fact, the scientifically correct statement should have been the "detection of physical particles predicted by the unobservable top quark." At any rate, the same experimental results are admitted by other theories not assuming quarks as physical particles in our spacetime (see next chapter),

The claim to have "measured the top quark mass" passes all boundaries of serious science because quarks cannot have gravity, as well known to qualified experts (see Chapter 1 and next section), thus rendering "quark masses" mere ad hoc parameters introduced to fit a preferred theory. In any case, the implausible high value of the "top quark mass" is a mere result of using an excessively elementary mathematics in excessively complex physical conditions because the use of isomathematics would dramatically reduce such an unreasonably high value the "quark mass" while keeping the same experimental data on physical, that is, actually observed particles.⁶⁷

Similar dark shadows in the European history of science exist for the various claims at CERN, GRAN e and other laboratories to have "detected neutrinos" to the point of sending them across Europe from one laboratory to another, with the equal claim to have "measured neutrino masses" [85]. As limpidly stated by Enrico Fermi, "neutrinos cannot be directly detected" for the obvious reason that they are neutral./ hence, the scientifically correct statement should be the "detection of physical particles predicted by the neutrino hypothesis." Similar vast issues of scientific ethics occur in the very claim that neutrino have masses, let alone that they have been measured (see next chapter).

It is obvious to the educated observer in good faith that these far reaching and so objectionable claims are purely political motivations to secure money, prestige and power via the abuse of the credibility of the releasing institutions, for real science requires a dramatically more cautious language.

To illustrate the unreassuring condition of particle physics, in this appendix we show how easy is to manipulate experimental data for the pre-set objective of fitting the desired theory. The illustration is done by re-elaborating the data of Grossman's tests [53] and showing that they can be turned, from their claim of verifying Einsteinian doctrines, into a form showing deviations and full verification of Aronson's results [52].

To minimize additional scientific manipulations expected from this presentation, the author stresses that *no position is here assumed as to whether or not experiments [53] had indeed been manipulated to serve political interests, because*

⁶⁷The reduction of current experimental beliefs on quark masses is a direct consequence of the strong convergence of divergent quantum perturbation series under isotopy (see EHM II and Chapter 3).

that position would be itself political, the only [possible scientific statement being lack of final experimental resolution at this writing one way or another.

The main objective of this section is to show the need for the conduction of contemporary particle experiments under the supervision of external Committee on Scientific Ethics and Accountability. Following fifty years of research experience, the author is forced to state again that *no basic advancement in scientific knowledge is possible without the joint consideration of scientific ethics and accountability.*

To begin, the author wants to be on record to testify that, immediately following the appearance of Grossman's claims [53], all papers submitted to journals of the *American Physical Society* (APS) on possible deviations from the Einsteinian decay law were rejected by APS editors with written statements to the effect that "the verification of the Einsteinian decay law has been confirmed by Grossman's tests" [53].

This editorial posture must be denounced since a serious statement should have been "the validity of the Einsteinian decay law has been confirmed by tests [53] in the range from 100 to 400 GeV, but deviations have been reported by Aronson et al [52]," rather than the absolute confirmation ventured by APS editors for all values of the energy, a posture that is evidently implicit in the releases statement.

In any case, tests [53] were and remain to this day very controversial because of a number of equivocal assumptions in the data elaboration, some of which are identified below. This nonscientific posturing by APS editors confirmed (or perhaps initiated) rumors that Grossman's tests [53] had been "commissioned" by organized interests on Einsteinian doctrines following the claim of departures in Ref. [52]. Consequently, so the rumors say, the experimental data had been manipulated to meet pre-established political objectives.

As studied in the preceding and in this volume, all available conceptual, epistemological, theoretical, phenomenological and experimental evidence suggest deviations from the Minkowskian spacetime inside hadrons, with the sole exception of the Grossman tests [53]. the sole evidence that photons cannot propagate within the hyperdense medium inside hadrons is sufficient to cast serious shadows.

A re-elaboration of tests [53] was conducted in in 1998 by Yu. Arestov et al. [57] of the Institute for High Energy Physics of Protvino, Russia, by focusing the attention on the range-energy selection rule which can be applied to re-elaborate the initial data on K_s decays. In this section we shall use re-elaboration [57] and develop it further along the lines above indicated.

Arestov et al. first obtained the raw data of tests [53] and initiated their re-elaboration via a new Monte Carlo simulation of the main features of the experiment and made new fits for K_s^0 . To begin, the parameters in the full formula dN/dt for the proper time evolution are strongly correlated. This may cause a generally non-relevant regular dependence of the parameters on entities

which are not present in the formula, such as number of runs, energy, etc., apart from systematic uncertainties. Therefore, the above dependence may shadow the weak energy dependence, as can be seen from the large values of the correlation elements.⁶⁸

Ref. [53] solved the problem of non-correlated fits by selecting the K_S^0 momenta greater than $100\text{GeV}/c$, an assumption that prevents the use of the results below $100\text{GeV}/c$. By means of that energy cut, Ref. [53] obtained the data sample in which the CP violating terms contribute up to 1.6%.

A first apparent manipulation of Grossman's tests [53] occurred in looking for deviations from the Einsteinian decay law of the order of a few percentages. This is manipulatory because known by experts to be unrealistic, since all expectations are to look for deviations from the Einsteinian law of the order of 10^{-3} , as suggested by studies [48-52].

The confirmation of a possible manipulation is given by the fact that the assumption in Ref. [53] of 1.6% contribution from PC violation in the data elaboration implies looking for the energy dependence of τ_s at the level $k \times 10^{-2}$, thus rendering meaningless *ab initio* to look for more realistic deviations of the order of 10^{-3} or smaller.

Ref. [53] significantly suppressed the CP violating terms by using selection rule for the ratio R/E , where R and E represent the K_S^0 range and energy. In experiment [53], R/E ranges from 2.3 to 36.1 cm/GeV. The R/E interval should be selected to make the contribution of the CP violating terms less than a desirable value, say $k \times 10^{-3}$. An effective (R, E) plot can then be calculated via Monte Carlo methods applied to the real decay volume.

Note that the above assumption caused in Ref. [57] to *lower statistics*, thus increasing the credibility of the data re-elaboration of Ref. [57] over that of the original paper [53]. In fact, under the above new assumptions, 60 – 70% of the events are rejected, i.e., only 63K – 84K events of the total 220K events were used in Ref. [57]. Apart from the loss of a major part of the data, 1/3 of the decay volume in the experiment turns out to be also useless.

The large inefficiency of experiment [53] occurred because it had not been optimized for the problem. Basically, the experimental design and data selection

⁶⁸The author jointly submitted paper [57] to *four* editors of *Physics Letters B* specifically selected because belonging to CERN, the paper essentially suggesting in due scientific language that CERN should repeat experiments [52,53] and finalize such a fundamental aspect of particle physics BEFORE spending additional public funds in the field. All four editors rejected the paper with a single signed letter stating that the paper was "excessively speculative," the same editors routinely accepting papers on neutrino and quark conjectures, evidently, as non-speculative. Following a long personal experience, it is the author's opinion that, in view of the billions of euros involved, the abuse of the laboratory credibility, the academic power of its leaders, and other factors, *no truly basic advance of physical knowledge can possibly occur at CERN without judicial injunctions for misuse of public funds and other charges initiated by European taxpayers*, the expectation that physicists at CERN may listen to scientific arguments being very naive or proffered by accomplices.

rules followed that of conventional K_s , K_l studies. A comparison of the statistics selected in re-elaboration [57] with the elaborations [53] then adds additional credibility to the rumors that Grossman's tests were commissioned.

Ref. [57] then illustrated the above arguments with two fits shown in the figure below, illustrating K_S decays at six energy values (from 125 to 375 GeV) that were generated in the decay volume with the ranges from 9.3m to 25.3m. The energy dependence of the lifetime was assumed in the form

$$\tau(E) = \tau_S(1 + \epsilon E), \quad \tau_S = 0.8927, \quad \epsilon = 4 \cdot 10^{-5}. \quad (6.A.1)$$

After applying the range-energy selection rule, a sample of 64K events was chosen in Ref. [57] for which the contribution of the CP violating terms was less than 0.008. Namely Ref. [57] dealt with the following distribution for the proper lifetime:

$$\frac{dN}{dx} = N\{\exp(-x) + \text{CPV}\}, \quad (6.A.2)$$

where N is a normalization constant, $x = t/\tau(E)$ and CP violating terms are equal to

$$\text{CPV} = |\eta_{+-}|^2 \exp(-xy) + 2D |\eta_{+-}|, \quad (6.A.3)$$

$$|\cos(\Delta m t - \phi_{+-}) \exp(-x(1+y)/2)| \quad (6.A.4)$$

where y stands for $\tau_s(E)/\tau_\ell$.

The values of other parameters are taken as the world average values. They are

$$|\eta_{+-}| = 2.284 \cdot 10^{-3}, \quad (6.A.5)$$

The magnitude of the CP-nonconservation parameter in the expression

$$K_\ell^o \rightarrow \pi^+\pi^-, \quad \phi_{+-} = 43.7^\circ, \quad \Delta m = 0.5333 \cdot 10^{10} \hbar \text{sec}^{-1} \quad (6.A.6)$$

is given by the mass difference of K_ℓ^o and K_s^o . The dilution factor D is defined as the ratio

$$\frac{N - \bar{N}}{N + \bar{N}}, \quad (6.A.7)$$

where N (\bar{N}) is the number of K^o (\bar{K}^o) produced by the proton beam on the target.

Note that Ref. [57] accepted the value $D = 0.75$ of Ref. [53]. The sequence of the mean proper lifetimes is plotted in the figure below versus E , the K_s^o laboratory energies. The dependence was obtained by simulations of K_s^o decays in the experimental volume under the conditions described above.

The figure presents two fits obtained by Arestov et al [57] with the energy-dependent formula of the type

$$\tau(E) = 0.8927(1 + p_1 E), \quad (6.A.8)$$

and the values

$$\tau(E) = c, c = 0.90 \pm 0.01, \chi^2/ndf = 0.7/5, \quad (6.A.9)$$

represented by the dashed line at top left of the figure, and

$$p_1 = (4 \pm 5) \cdot 10^{-5}, \chi^2/ndf = 0.38/, \quad (6.A.10)$$

represented by the solid line top left.

For comparison, Ref. [57] performed also the two-parameter fit to the formula of Ref [53],

$$\tau(E) = p_2(1 + p_1 E) \quad (6.A.11a)$$

$$p_1 = (4 \pm 23) \cdot 10^{-5}, \quad (6.A.11b)$$

with $\chi^2/ndf = 0.38/4$.

There is a difference in interpretation of parameters in the two fitting formulae with the energy dependence. The parameter p_2 in the fit from paper [53] was interpreted as the zero-energy mean value of the proper lifetime. It is difficult to extrapolate the fitting formulae from the energy interval $100 - 400 GeV$ to zero. Instead, Ref. [57] used the energy dependence in a limited energy interval by fit starting from a definite point. This difference in interpretation is important because, in general, various approaches in fitting procedures may lead to crucially different numerical results, thus confirming beyond credible doubt the possibility of manipulating the data elaboration to verify any pre-set beloved doctrine.

Thus, in the amount of the events selected in Ref. [57], both fits dig up well the mean value of the hidden parameter ϵ determining the energy dependence in the simulated K_S^0 decays, but the error bars differ strongly. Though both results for fitting the values of p_1 are still insignificant statistically, even in the selected sample of events, the 100% error bar in fit [57] being rather promising. a pre-set goal.

An additional possibility, we note here that no firm spacetime verification of the Einsteinian decay law can be established via elaboration [53] for PC violating contributions of the order of 1.6% because possible anomalies are within the errorbars due to insufficient statistics of tests [53] and other reasons.

Arestov et al concluded their analysis in paper [57] with the statement: *The analysis of this paper establishes the insufficiencies of the tests by Grossman et al. and the need for final, more accurate measurements as the only way to resolve the now vexing fundamental problem of the spacetime geometry and physical laws holding in the interior of the hyperdense hadrons. After all, as indicated earlier, the isominkowskian fit of experiments [55-56] establishes the existence of spacetime anomalies with superluminal speeds in the interior of hadrons even in the event that measurements [53] result to be correct.*

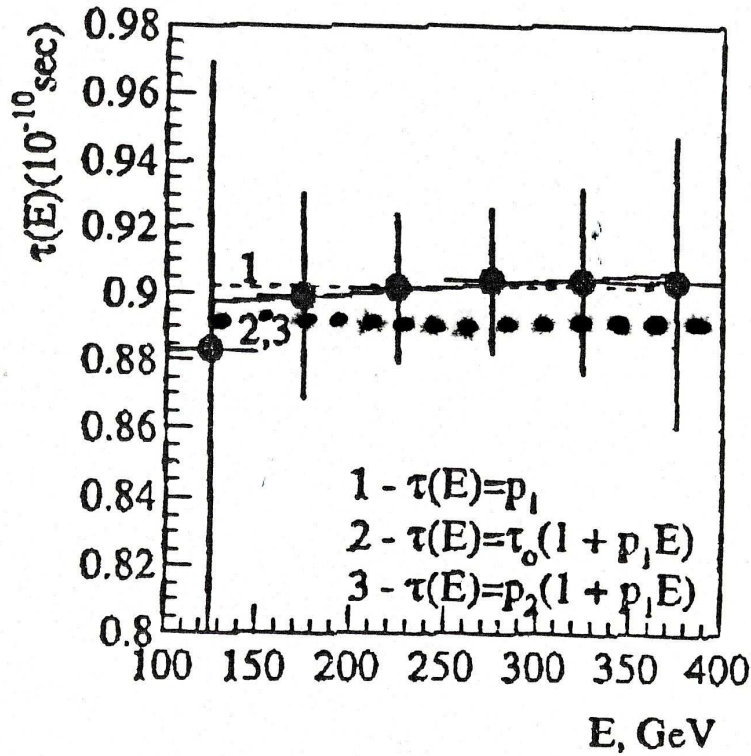

Figure 6.A.1. Re-elaboration of the experimental data of the experiments by Grossman et al [53] for the lifetime $\tau(E)$ dependence on energy. The dashed line (top left) and the continuous line (middle left) are the re-elaboration of said data as published by Arestov et al [57] to illustrate the lack of final character of the claims contained in paper [53]. The dotted line (left bottom) presents re-elaboration by the author via different fitting functions and other minor changes to illustrate how easy it is to manipulate contemporary experiments for the pre-determined intent of fitting Einsteinian doctrines. This establishes the need for the conduction of any and all particle physics experiments under the strict control of an external Committee on Scientific Ethics and Accountability. The occurrence also established the need for an in depth apolitical review of ALL recent particle experiments based on Einsteinian doctrines for conditions different then those of its original conception. Finally, the re-elaboration confirm the new for a *a new code of laws* addressing scientific manipulations, as suggested in the text

The author has re-examined the above analysis under profiles pertaining to scientific ethics and accountability. It is evident that the "experimental verification" claimed by Grossman et al [53] could have been intentionally achieved via virtually endless manipulations of the data elaboration, all presented under

a patina of seemingly technical calculations, although solely capable of fouling readers without sufficient technical knowledge.

To mention only one among numerous possible adulterations, statistical and other conditions can be selected in such a way that the deviations from Einsteinian doctrines are of the order of magnitude of the error, and then claim verification of said doctrines. In any case, the rumors persist that this was indeed done by Grossman et al [53] and by the editors of the APS with *their* publication of the paper.

Such a visible absence of serious editorial processing is systematically implemented by APS editors for papers claiming experimental verification of Einsteinian doctrines and quantum mechanics. By contrast, the more important papers claiming experimental deviation from said doctrines are subjected by APS editors to brutal "reviews" intended to discourage the continued submission via a never ending sequence of criticisms on manifestly tangential issues, without issuing, in general, a formal rejection.

It is equally evident that there exist a large number of possibilities to manipulate the data to reach pre-set departures from the Einsteinian decay law. As a matter of fact, the alternatives are so many to be embarrassing. In the figure we report deviations from the Einsteinian decay law (dotted line at bottom left) obtained via a 5% change of the PC violating parameter, a different value of the fitting function and other small "adjustments."

Note that the deviations from the preceding two curves is intentionally small because it could have been as large as desired. In particular, simple "adjustments" in the selection of the statistics, reduction of the PC parameter, suitable selection of the fitting function and others things can easily produce deviations 3-4 times bigger than the error. Their study is left as an instructive exercise for the ethically sound scholar.

It is hoped that educators, administrators and editors seriously committed to serious science see the necessity of *a new code of laws* encompassing scientific crimes, as well as the necessity that all contemporary experiments, whether in favor or against Einsteinian doctrines, be subjected to controls by an external Committee on Scientific Ethics and Accountability prior to publication. Educators, administrators and editors should never forget that what is at stake is the ability or inability to solve increasingly alarming environmental problems in our planet. In plain language, leaving the status quo in the current conduction of basic science is not only unethical, and irresponsible but actually suicidal.

Appendix 6.B

Ethical Problems in String Theories

In preparation as of October 1, 2007.

See the catastrophic inconsistencies of string theories published in a refereed journal of which the author is not an editor

R. M. Santilli, "New problematic aspects of current string theories and their apparent isotopic resolution,"

Foundation of Physics **32**, 1111(2002)

Serious ethical problems emerge because these catastrophic inconsistencies have remained totally ignored by organized interests in the field.

Until physicists were playing personal games of purely mathematical curiosity in string theories, they were tolerated. Now that laboratories are raising large public funds for experiments on a theory proved to be catastrophically inconsistent on physical grounds, without first disproving such inconsistencies in equally refereed publications, judicial action is necessary to prevent this unethical condition and conduction of basic scientific knowledge.

Appendix 6.C

Ethical Problems in Black Holes

In preparation as of October 1, 2007. See

Jeremy Dunning Davies, *Exploding a Myth*
Harwood, England (2007)
ISBN 978-1-904275-30-5

In Santilli's view, Black holes constitute one of the most sinister episodes in the history of science because of an excessively long list of excessive ethical problems, all ignored because of the illusion of achieving credibility via the abuse of academic authority, complemented by the illusion that all physicists are naive or gullible.

As one indication, current studies of black holes, in the form appearing in publications, dishonor the memory of Schwartzchild who wrote *two* historical papers, one on the *exterior* solution and one on the *interior* problem. Even though black holes constitute the ultimate interior gravitational problem in the universe as known these days to high school students these, they are treated with the exterior solution, while being completely silent on the interior character due final incompatibility with Einsteinian doctrines, the only possible bypassing of ethical problems being an admission of scientific illiteracy.

Additional ethical problems are caused by the complete ignorance of the catastrophic mathematical and physical inconsistencies of Einstein's gravitation under the illusion that they disappear via silence, complemented by the illusion that abuses of academic authority produce certain mental slavery, while in reality setting up the illusionists for probable legal prosecution by contemporary colleagues and certain condemnation by posterity, for serious science can be solely based on a collegian addressing, rather than suppressing, of fundamental unresolved problems.

Appendix 6.D

Requested Experiments

Following a lifelong experience, the author regrets to state that physics used to be a science with an absolute standard of value, the experimental verification. Experiments themselves used to have their own standard of value, in the sense that experiments on fundamental unresolved aspects had priority over those of peripheral; relevance.

Nowadays, the standard of value is primarily set by academic power; the more fundamental a proposed experiment is, the bigger the opposition for its conduction; and, when undesired basic tests somehow manage to escape current restrictions, manipulated counter-experiments are soon commissioned to protect organized interests on Einsteinian doctrines (se Appendices 6.1.A, 6.1.B, 6.1.C).

These are the reasons for the view, repeatedly expressed by the author, that *nowadays, no basic aspects in physics can be seriously addressed without a joint consideration of issues pertaining to scientific ethics and accountability.* Hence, the author has long suggested the need for external Ethics Committees supervising basic research similar to those existing in other branches of science, particularly when the research is conducted under public financial support.

More recent events have shown that organized obstructions against undesired advances have increased with the increase of the evidence of the limitations of Einsteinian doctrines. Since the power and capillary organization of orthodox interests is beyond the imagination by outsiders, the author predicts that *no experiment on truly basic open issues is possible nowadays without legal proceedings against physics laboratories and their directors for misuse of public funds, discriminatory conduct, and other violation of federal laws.*

In this section we present n numerous basic experiments submitted by the author over three decades (see Refs. [81,6] and EHM II) to all major laboratories around the world whose list and related documentation will be disclosed at the appropriate future time in the appropriate conduit. Even the "consideration" of the experiments herein proposed by flatly rejected, let alone their "conduction."

To appraise the gravity of the situation, the "consideration" of the basic experiments reviewed below was rejected even though their costs was at times quite moderate with very large scientific implications whatever the outcome, while other experiments were preferred of immensely bigger costs to the taxpayer, without any major relevance, and often intended to test sheer theological beliefs. The

reason for this disparity documented beyond credible doubt, and continuing to this day in any case at all major physical laboratories around the world, is that the later experiments were aligned with Einsteinian doctrines while the former were not.

In view of such a deplorable condition of physics, and the expectation of its resolution via judicial proceedings, in his capacity as a U. S. taxpayer, the author has changed the original titles of "Suggested Experiments" into "Requested Experiments." Readers who interpret the content of this section as aimed at "proving Einstein wrong" and the like, are disqualified as being outside serious science because, as shown by scientific history, serious science is solely conducted via serious experiments *irrespective of whether in favor or against a preferred theory*. The endless distortions, deviations, peripherals, and the like the author has been exposed too over decades are mere schemes aimed at personal gains in money, prestige and power.

REQUESTED EXPERIMENT 1: Measure the possible isoredshift of light from a quasar before and after passing through a planetary atmosphere (such as that of Jupiter) or an astrophysical chromosphere (such as that of the Sun).

The above test was first proposed by Santilli the early 1980s when at Harvard University, and then reviewed in a number of publications such as Ref. [81] of 1988 and subsequent works (see monograph [6] in particular) and papers quoted therein.

The reason for the impossibility of astrophysical laboratories to even consider the experiment, let alone conduct it, is that, at the time of the proposals, the author was still naive, in the sense of still believing in the above quoted absolute standards of values on which the preceding history of physics was based upon. In fact, the respectful "suggestions" to consider Experiment 1 included a detailed identification of its fundamental implications. The suppression of the consideration was due to such an identification. In different terms, had the experiment been disguised by misinformation on title and content, perhaps there would have been a chance at least for its consideration.

Had, in the United States of America, any astrophysics laboratory formally "considered" Experiment 1, that laboratory would have seen the termination of research funding by the Department of Energy, the National Science Foundation, and other governmental agencies or private foundations. Under these conditions in the U.S.A., foreign astrophysical laboratories had no other choice than align themselves with organized interests in the U.S.A. ⁶⁹ It is important to identify

⁶⁹Documentary evidence of ONE research contract existing at this writing (October 23, 2007) by the D.O.E. or the N.S.F. funding experiments that could invalidate Einsteinian doctrines would be greatly appreciated for due corrections.

the political problems that have prevented the consideration of the test so far, because useful for serious scholars seriously interested in serious science.

POLITICAL PROBLEM 1: As recalled earlier, the "universal constancy of the speed of light" is maintained within physical media via the belief that photons scatter through atoms, thus causing a believed *increase of the travel time* through the medium that appears to us as a decrease of the light speed. The important political point is that, in this way, photons continues to travel in vacuum at the "universal value" c_o . By comparison, if successful, Experiment 1 would detect a *slowdown of the speed of light itself* because it is the sole capable of causing a redshift. Admitting the possibility of detecting the local variation of the speed of light would mean terminating the dominance of Einsteinian doctrines throughout all media in the universe, with consequential expected termination of funding perhaps in excess of one billion dollars, thus mandating the commissioning of counter-experiments, and similar scientific misconduct nowadays a routine in physics due to the total absence of any control by society.

POLITICAL PROBLEM 2: As shown below, the sole decrease of the speed of light is insufficient for serious science because the considered media are inhomogeneous and anisotropic. Experiment 1 is additionally intended to measure possible deviations from the homogeneity and isotropy of empty space, namely, something more damaging to organized interests on Einsteinian doctrines than the mere change of the speed of light, with consequential, expected, increased reactions, obstructions, schemes, manipulations, and the like.

POLITICAL PROBLEM 3: If successful, Experiment 1 would establish the exact validity within physical media of Santilli's isotopic covering of Einsteinian doctrines, including the exact validity of the iso-Minkowskian spacetime, the iso-Lorentz symmetry and related iso-axioms, namely, the proposed test would establish something expected to have truly large organized oppositions, obstructions and disruptions.

Following these necessary preliminary for outsiders to have a glimpse of the real experimental world in physics these days, we can now pass to an outline of the scientific case to the best of our capability. To keep a kilometric distance from orthodox interests, the presentation below is submitted as tentative and conjectural, for which very reason there is the need for an experimental verification, by keeping in mind that *the orthodox interpretation is equally tentative and conjectural, again, due to the lack of direct experimental verifications.*

As well known, the conventional *Doppler's law*, for the simpler case of null angle of aberration, is given by

$$\omega = \omega_o \times \frac{1 - \beta}{\sqrt{1 - \beta^2}}, \quad \beta = \frac{v}{c_o}, \quad (6.1.129)$$

where c_o is the speed of light in vacuum, and can be written via a power series expansion

$$\omega = \omega_o \left[1 - \frac{v}{c_o} + \frac{1}{2} \times \left(\frac{v}{c_o} \right)^2 + \dots \right]. \tag{6.1.130}$$

As also well known, $v \ll c_o$, $v/c_o]ggv^2/c_o^2$ and, consequently, the term v/c_o dominates the expansion. We can then write

$$\omega \approx \omega_o \times \left(1 - \frac{v}{c_o} \right). \tag{6.1.131}$$

Also, $v/c_o \ll 1$. Consequently, Eq. (6.1.131) represents a *decrease* of the original frequency ω_o . Then, for $v \neq 0$, we have a *redshift* that can be defined as⁷⁰

$$\Delta_\omega = \omega_o - \omega > 0. \tag{6.1.132}$$

It is equally evident in Eq. (6.1.131) that, in the event, for a given value of v , there is a decrease of the speed of light within the selected planetary atmosphere or astrophysical chromosphere, namely,

$$c_o \rightarrow c = c_o \times b_4 = \frac{c_o}{n_4}, \quad b_4 < 1, \quad n_4 > 1, \quad c < c_o, \tag{6.1.133}$$

Eq. (6.1.131) becomes

$$\omega \approx \omega_o \times \left(1 - \frac{v}{c_o} \times \frac{1}{b_4} \right) = \omega_o \times \left(1 - \frac{v}{c_o} \times n_4 \right). \tag{6.1.134}$$

As one can see, *in the event, for a given v, we have a decrease of the speed of light within the medium considered, the redshift is bigger*, exactly along the Section 6.1.11.

It is equally easy to see that Eq. (6.1.134) is geometrically unbalanced and incomplete because inhomogeneity can be represented with a dependence of the index of refraction on the local coordinates, $n_4 = n_4(r, \dots)$ (since n_4 represents the local density), but we lack a representation of the anisotropy of the medium considered caused by its rotation with consequential preferred direction in space. The latter requirement leads uniquely and unambiguously to Isoaxiom IV with isotopic law

$$\omega = \omega_o \times \frac{1 - \hat{\beta}}{\sqrt{1 - \hat{\beta}^2}}, \tag{6.1.135a}$$

$$\hat{\beta} = \frac{v}{c_o} \times \frac{b_s}{b_4} = \frac{v}{c_o} \times \frac{n_4}{n_s}, \tag{6.1.135b}$$

⁷⁰We should caution the reader that there are numerous different definitions of redshifts in astrophysics.

and final approximate expression

$$\omega \approx \omega_o \left(1 - \frac{v}{c_o} \times B\right), \quad (6.1.136a).$$

$$B = \frac{b_s}{b_4} = \frac{n_4}{n_s} \quad (6.1.136b)$$

where we have assumed, again, spherical symmetry for simplicity.

The following estimates of isoredshift for quasars light passing through Jupiter's atmosphere was reached in Ref. [6b], Section VII.4 and VII.5. The average value of the characteristic quantity B in the data of Fig. 6.1.13 is

$$B_{aver} = 72.58 \quad (6.1.137)$$

from which we have the average redshift of quasars

$$\Delta_{\omega}^q = 1.15, \quad (6.1.138)$$

with corresponding average redshift of the associated galaxies

$$\Delta_{aver}^g = 0.001. \quad (6.1.139)$$

From astrophysical and planetary data we can assume, in first approximation, that quasar chromospheres ("q") are about 10^5 denser than Jupiter's atmosphere ("j"), and by recalling that $n_4 = 1/b_4$ represents the density d of the medium considered, we have the proportionality

$$\frac{B_{aver}^q}{B^j} \approx \frac{d_{aver}^q}{d^j}, \quad (6.1.140)$$

with the estimate value of B for Jupiter [6b]

$$B_{est}^j = 7.3 \times 10^{-4}, \quad (6.1.141)$$

and the corresponding estimate of the isotopic redshift for quasar light passing through Jupiter's atmosphere predicted by isorelativity

$$\Delta_{est}^q = 1.14 \times 10^{-5}. \quad (6.1.142)$$

Individual values for b_s and b_4 can then be obtained from comparative measurements of the predicted decrease of the speed of light within Earth's atmosphere presented below, since such value would provide a good approximation of the corresponding value of b_4 for Jupiter. The value of b_s would then follow from the value of B .

"Requested" Experiment 1 suggests first to measure the quasar redshift in empty space via available instruments and techniques and then measure it again

when the same light passes through Jupiter's atmosphere. The experiment is readily feasible because it requires no new equipment, but merely the *extension* of conventionally conducted measurements only under new conditions. Also, estimate (6.1.141) is fully within current experimental feasibility.

To understand the gravity of contemporary experimental physics, noninitiated readers should know that the consideration, let alone conduction of Experiment 1 was rejected also by astrophysical laboratories that were conducting measurements of quasars redshifts, hence requiring no additional funds.

Said gravity is further illustrated by the fact that Experiment 1 requires, in reality, only a *confirmation*, since NASA planetary missions have provided apparent data showing exactly the isodoppler effect of Experiment 1 for the case of electromagnetic communications with satellites when passing through planetary atmospheres or the Sun's chromosphere. Regrettably, the author was unable to collect these data or possible references thereof, and their indication by interested colleagues would be greatly appreciated for due revisions.

The following alternative of Experiment 1 was submitted in Refs. [81,6b] but equally ignored by astrophysical laboratories:

REQUESTED EXPERIMENT 2: Measure from a satellite the possible isoredshift of light originating from a far away star or quasar when passing through Earth's atmosphere.

It is evident that possible comparative measurements of isoredshift in Jupiter's and Earth's atmospheres would yield invaluable scientific information on the geometries of physical media, particularly useful for new energies depending on spacetime anomalies, as we shall see.

The following third experiment is partially responsible for the view often expressed by the author that *the most ascientific process of contemporary physics is the scientific process*. The view is caused by a widespread dismissal of plausible dissident views, this time dealing with the *origin of the tendency toward the red of Sun light at sunset*.

REQUESTED EXPERIMENT 3: Measure at the equator the expected isoredshift of sunlight in the transition from the zenith to the horizon.

It is popularly believed that the "redness of sunsets" is caused by the absorption by our atmosphere of blue and other light resulting in the dominance of red visible by all of us. This view is not reason for debates. The problems originate when said view is assumed as the origin of the *entire* tendency toward the red at sunset, since there are *three* additional plausible contributions, all deserving experimental verification.

Conventional Doppler's effect. Earth's rotates. Hence, an observer at the equator is moved *toward* the Sun. It then follows that, at least one contribution of the "redness of sunsets," is a bona-fine, conventional redshift. In fact, said observer has the following tangential speed toward the Sun

$$v = 0.46Kw/s \quad (6.1.143)$$

resulting in the value

$$\beta = \frac{v}{c_i} = 1.57 \times 10^{-8}. \quad (6.1.144)$$

Despite its smallness, the latter value causes a conventional Doppler's shift visible by the naked eye and given by half of the visible difference of the tendency toward the read between sunset and sunrise. In fact, the observer is moving it away from the Sun at sunrise, thus causing a *blueshift* (because in this case the negative sign in Eq. (6.1.134) is turned into a positive sign). Clearly this contribution "requires" an experimental verification or denial.

Decrease of the light speed. Light decreases in speed about 33 % in water.⁷¹ Since the ratio of the densities of water and atmosphere is of about 10^3 , in Earth's atmosphere, Sun light speed is expected to decrease in the approximate value

$$c = c_o \times b_4 = \frac{1}{3} \times c_o \times 10^{-3}. \quad (6.1.145)$$

Since effect (6.1.144) is visible to the naked eye, effect (6.1.145) "requires" an experimental verification or denial because 10^5 times bigger than the former.

Full isotopic effect. Again, law (6.1.135) for value (6.1.145) is geometrically inadequate, requiring the full isotopic law (6.1.135). The latter effect also deserves experimental verification or denial because Earth's atmosphere is expected to be a medium of Group II, Type 5, for which b_s is *smaller* than b_4 , as a result of which *the anisotropy of Earth's atmosphere is expected to decrease the redshift predicted by the decrease of light speed.*

Experiment 3 can be conducted quite easily via currently available spectrometers, by first selecting one or more spectral lines at the zenith and then following them to the horizon. Possible errors in following the Sun can be compensated with a broader selection of spectral spectral lines, with the understanding that current astrophysical equipment can follow the micrometric motion of far away stars, thus being amply sufficient for the simpler motion herein considered.

Note that Experiments 1 and 2 are intended to ascertain whether or not an *already redshifted* light can experience an additional redshift when passing through a

⁷¹Despite this large decrease, readers should not expect a redshift in a glass of water due to the need for a large water volume to reach a measurable effect.

medium. Experiment 3 is intended to ascertain whether or not light not originally redshifted can be redshifted by passing through a medium. Hence, Experiments 1 and 2 could be successful even in the event Experiment 3 is not.

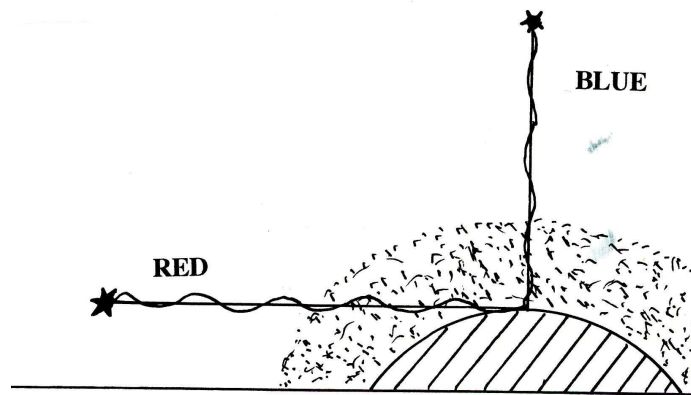

Figure 6.D.1. A schematic view of the Experiment 3 intended to ascertain whether or not, an observer at the equator following the transition from the zenith to the horizon, sunlight experiences three different contributions to the redness at sunset: 1) A conventional Doppler's redshift due to motion of the observer toward the Sun; 2) An isotopic redshift due to the predicted decrease of the speed of light within Earth's atmosphere; and 3) A blueshift reduction of the preceding redshift due to the anisotropy of the medium caused by Earth's rotation. As illustrated in the text, it should be stressed that isotopic contributions *cannot* turn blue light at the zenith into red light at the horizon. Hence, the proposed tests refer to *contributions* to the redness at sunset while keeping the conventional interpretation valid in first approximation (that Earth's atmosphere at the horizon absorbs the blue leaving the red as dominant). Despite its secondary numerical value, if confirmed, said contributions would have far reaching physical, astrophysical and cosmological implications.

We have indicated in the preceding section the current "experimental beliefs" on the expansion of the universe because redshifts measurements (that are not questioned here) are interpreted with the unverified assumption that light propagates through the immense astrophysical chromospheres at the same speed as that in vacuum. This results in an "experimental belief" because actual measurements are used to proffer personal unverified theoretical views, a rather widespread practice in contemporary physics, as we shall see.

To turn this theological condition of astrophysics into serious science, the author proposed in Ref. [6b], Sect. VII.5 the following additional test:

REQUESTED EXPERIMENT 4: Measure at one of the poles the possible isoredshift of sunlight from the zenith to the horizon.

The evident main difference between Experiments 3 and 4 is that, in the former case, we do have motion of the observer toward the Sun while, in the second case, the observer can be approximately considered to be at rest with respect to the Sun. Hence, Experiment 4 has a fundamental character for astrophysics, for which reason the author "requests" its conduction as a U. S. taxpayer. In fact, the test would permit the study:

1) Whether or not far away astrophysical bodies may exhibit a redshift while being at rest with respect to Earth;

2) Whether or not the currently believed expansion of far away astrophysical bodies should be decreased because of isotopic contributions from the slow down of the speed of light in their chromospheres; and?

3) Whether or not astrophysical bodies currently believed to be expanding from Earth are in reality moving toward Earth, trivially, because the isotopic redshift due to the chromosphere could be bigger than the blueshift due to motion.

The theology underlying the above open issue is essentially similar to that on antigravity, namely, "Einsteinian theories predict spectral shifts only under relative motion and, therefore, when there is no shift, the bodies are at rest with respect to each other." However, physical reality is definitely much more complex than this theological posturing.

The preceding experimental verifications of isorelativity have established that $n_4 = 1/b_s$ represents the local density d thus depending on the local coordinate r , $n_4(r, d, \dots) = 1/b_4(r, d, \dots)$. In the preceding calculations, $n_4 = 1/b_4$ has been averaged to a constant for simplicity. By contrast, the space component $n_s = 1/b_s$ depends on the speed and, trivially, from the energy E [81], $n_s(v, E, \dots = i/b_s(v, E, \dots)$. Hence, the isotopic law can be explicitly written

$$\omega \approx \omega_o \times \left[1 - \frac{v \times b_s(v, \dots)}{c_o \times b_4(r, \dots)} \right]. \quad (6.1.146)$$

Since the functional dependence of the characteristic quantity b_s on the speed is unknown at this writing, we cannot apriory assume that $\Delta_\omega = 0$ for $v = 0$ in Eq. (6.1.146). The only possible serious pursue of scientific knowledge is that via unbiased experiments, to be sure, conducted under an external Ethics Committee.

In summary the above possibilities 1), 2) and 3) may originate, not only from, a possible slowdown of the speed of light in astrophysical chromospheres, but also and independently, from, the anisotropy of the medium considered.

An illustration of one of the numerous scientific manipulations used to oppose the above proposed experiments is necessary to inform the serious scholar. The dismissal of the (at that time) "suggested" experiments was once voiced

by a seemingly senior "scientist" belonging to seemingly "leading" university on grounds that "Santilli believes that blue light at the zenith can be turned into red at the horizon via his mathematics." The following comments are then in order in the hope of at least preventing the repetition of the same "objection" against basic experiments.

The mid-blue ("b") at the zenith is characterized by the following frequency

$$\omega^b = 6.34 \times 10^{14} Hz, \quad (6.1.147)$$

while the mid red ("r") at the horizon is characterized by

$$\omega^r = 4.38 \times 10^{14} Hz, \quad (6.1.148)$$

with ratio

$$\frac{\omega^r}{\omega^b} = 0.69. \quad (6.1.149)$$

The hypothetical "redshift" from blue to red would then require

$$\omega^r = \omega^b \times \left[1 - \frac{v}{c_o} \times b\right], \quad (6.1.150a)$$

$$1 - \frac{v}{c_o} \times B = 0.69 \quad (6.1.150b)$$

$$B = 1.4 \times 10^7 \quad (6.1.150c)$$

where we have used value (6.1.143).

It is evident that *value (6.1.150c) is impossible in Earth's atmosphere*. Since it was proffered by a seemingly qualified senior "scientist" belonging to a qualified University, the statement "Santilli believes that blue light at the zenith is turned into red at the horizon via his mathematics" was an act of sheer scientific corruption intended to oppose, jeopardize or prevent undesired basic experiments for personal gains in money, power and prestige. Very unfortunately for society, physics is nowadays done via academic power. Since the abused institution was credible, the dismissal was accepted rather widely by naive followers, and the suppression of the pre-meditated experiment was fully successful.⁷²

⁷²Since they lack technical arguments, corrupt academicians retort to all sort of nonscientific and tangential "arguments" to prevent the conduction of undesired basic experiments. Another objection was that "the tests are not warranted because Santilli did not work then out in all the necessary experimental details." The corrupt character of the "objection" is soon identified by recalling, for instance, that the discovery of the Ω^- was done by *experiments worked out in their technological details by experimentalists* following the *purely theoretical* prediction via $SU(3)$ symmetries. The evident reason for this evident disparity is that the latter test was fully aligned with Einsteinian theories while the former are not. Another "objection" voiced by another "physicist" is that "the experiments have no sense because Santilli believes that quasars have atmospheres." The "objection" originated from a mistake by the author in Ref. [6a] of using, in one passage, the word "atmosphere" in lieu of "chromosphere," and this was reason for the successful suppression of the tests. The author spares the reader the report of additional "objections" because their very reading is demeaning for what is supposed to be a serious scientific process.

We close this section with the following fifth fundamental tests that are mandatory for any basic advance in hadron physics, while additional tests will be reviewed and "requested" in the remaining parts of this volume.

REQUESTED EXPERIMENT 5: Achieve final experimental resolution of the behavior of the meanlives of unstable hadrons with speed.

The need to conduct this fifth experiment, and the necessity of its conduction under an external Ethics Committee, are presented and documented in Appendix 6.1.A.

It is hoped that physics laboratories will conduct the much needed *basic* tests under the strict supervision of external Ethics Committees so as to prevent their otherwise inevitable conduction under judicial injunctions due to misuse of public funds, discriminatory practices, and other violations of Federal Laws that are inherent in the current use of public funds for generally very expensive experiments based on essentially unsettled foundations.

TO BE COMPLETED WITH ADDITIONAL TRESTS

References

- [1] R. M. Santilli, *Why Space Is Rigid*, in Italian, Il Pungolo Verde, Campobasso, Italy (1956).
- [2] M. Jammer, *The History of Theories of Space in Physics*, Harvard University Press, Cambridge (1954).
- [3] A. Lorentz, *Versuch einer Theorie der Elektrischen und Magnetischen Erscheinungen in Bewegten Körpern*, Leyda (1895).
- [4] R. M. Santilli, *Lett. Nuovo Cimento* **37**, 545 (1983) [4a] and *Lett. Nuovo Cimento* **38**, 509 (1983) [4b].
- [5] R. M. Santilli, *Hadronic J.* **8**, 25 and 36 (1985) [5a]; *Hadronic J. suppl.* **5**, 1 (1989) [5b]; JJINR Communication No. E4-93-352 (1993). *Acta Applicandae Math.* **50**, 177 (1998) [5d]; *J. Moscow Phys. Soc.* **3**, 255 (1993) [5e]; *JINR Rapid Comm.* **6**, 24 (1993) [5f]; Contributed paper in *Collection of Papers on the Lorentz Symmetry*, V. V. Dvoeglazov., Editor, Nova Publisher (1998) [5g].
- [6] R. M. Santilli, *Isotopic Generalizations of Galilei and Einstein Relativities*, Vols. I: *Mathematical Foundations* [6a], and II: *Classical Formulations* [6b], Hadronic Press, Palm Harbor, Florida (1991).
- [7] A. K. Aringazin et al., contributed paper in *Frontiers of Fundamental Physics*, M. Barone and F. Selleri, Editors, Plenum, New York (1995).
- [8] J. V. Kadeisvili, *Math. Methods in Applied Sciences* **19**, 1349 (1996).
- [9] K. Masudi, contributed paper to the *Proceedings of the International Conference on Dynamical Systems*, C. Ozel, Editor, International Academic Press, in press.
- [10] R. M. Santilli, *Int. J. Mod. Phys. D* **7**, 351-407 (1998).
- [11] R. M. Santilli, Contributed paper to the *Proceedings of the VII M. Grossmann Meeting on Gravitation*, R.T. Jantzen, G. Mac Keiser and R. Ruffini, Editors, World Scientific, Singapore, pp. 500-505 (1996).
- [12] R. M. Santilli, Contributed paper in the *Proceedings of the VIII Marcel Grossmann Meeting in Gravitation*, T. Piran, and R. Ruffini, Editors, World Scientific, pp. 473-475 (1999).
- [13] R. M. Santilli, *Galilean Electrodynamics* Vol. 17, Special issue **3**, 42 (2006).
- [14] R. M. Santilli, "On a possible Lie-admissible covering of the Galilei Relativity for nonconservative and Galilei form-noninvariant systems," Lyman Laboratory of Physics, Harvard University, Cambridge MA, under DOE contract DE-ACO2-80ER-10651.A001, published in the *Hadronic J.* **1**, 223-423 (1978), with addendum published in the *Hadronic Journal* **1**, 1279-1342 (1978) [this memoir set the mathematical foundations of hadronic mechanics presented in the adjoining memoir [50] of the same year] [14a]; R. M. Santilli, "Need for subjecting to an experimental verification the validity within a hadron of Einstein's Special Relativity and Pauli's Exclusion Principle," Lyman Laboratory of Physics,

Harvard University, Cambridge, MA, under DOE contract DE-ACO2-80ER-10651.A001, published in the Hadronic J. Vol. **1**, 574-902 (1978) [this memoir originated the proposal and construction of hadronic mechanics following the p[receding memoir [14a] on its Lie-admissible formulations] [14b].

- [15] R. M. Santilli, Rendiconti Circolo Matematico Palermo, Suppl. **42**, 7 (1996).
- [16] R. M. Santilli, Found. Phys. **27**, 625 (1997).
- [17] R. M. Santilli, Found. Phys. **121**, 1159 (1997).
- [18] R. M. Santilli, Nuovo Cimento B **121**, 443 (2006).
- [19] A. K. Aringazin, A. Jannussis, D. F. Lopez, M. Nishioka and B. Veljanosky, *Santilli's Lie-Isotopic Generalization of Galilei's Relativities*, Kostarakis Publisher, Athens, Greece (1980).
- [20] J. V. Kadeisvili, *Santilli's Isotopies of Contemporary Algebras, Geometries and Relativities*, Ukraine Academy of Sciences, Kiev, 2nd edition 1995.
- [21] Gr. Tsagas and D. Surlas, *Mathematical Foundations of the Lie-Santilli Theory*, Ukraine Academy of Sciences, Kiev (1993).
- [22] J. L ohmus, E. Paal and L. Sorgsepp, *Nonassociative Algebras in Physics*, Hadronic Press, Palm Harbor, FL, (1994).
- [23] R. M. Falcon Ganfornina and J. Nunez Valdes, *Fondamentos de la Isoteoria de Lie-Santilli*, (in Spanish) International Academic Press, America-Europe-Asia, (2001), also available in the pdf file <http://www.i-b-r.org/docs/spanish.pdf>
- [24] Chun-Xuan Jiang, *Foundations of Santilli's Isonumber Theory*, International Academic Press, America-Europe-Asia (2002), also available in the pdf file <http://www.i-b-r.org/docs/jiang.pdf> [4g].
- [25] S. Okubo, Hadronic J. **5**, 1667 (1982).
- [26] D. F. Lopez, in *Symmetry Methods in Physics*, A. N. Sissakian, G. S. Pogosyan and X. I. Vinitzky, Editors (JINR, Dubna, Russia, 1994).
- [27] D. F. Lopez, Hadronic J. **16**, 429 (1993).
- [28] A. Jannussis and D. Skaltsas, Ann. Fond. L. de Broglie **18**, 137 (1993).
- [29] A. Jannussis, R. Mignani and R. M. Santilli, Ann. Fond. L. de Broglie **18**, 371 (1993).
- [30] D. Schuch, Phys. Rev. A **55**, 955 (1997).
- [31] R. M. Santilli, Modern Phys. Letters **13**, 327 (1998).
- [32] R. M. Santilli, Found. Phys. **32**, 1111 (2002).
- [33] R. M. Santilli, I Nuovo Cimento **51**, 570-576 (1967).
- [34] L. C. Biedernharn, J. Phys. A **22**, L873 (1989).

- [35] A. J. Macfarlane, J. Phys. A **22**, L4581 (1989).
- [36] F. Cardone and R. Mignani, Found. Phys. **29**, 1735 (1999).
- [37] G. Junker, *Supersymmetric Methods in Quantum and Statistical Physics*, Springer-Verlag (1996).
- [38] G. Nimitz and W. Heitmann, Progr. Quantum Electr. 21, 81 [1997].
- [39] S. A. Enders and G. Nimitz, J. Phys. France 2, 1693 (1992) 8a.
- [40] E. Recami and R. M. Santilli, Hadronic J. **23**, 279 (2000).
- [41] R. M. Santilli, Lett. Nuovo Cimento **33**, 145 (1982).
- [42] V. de Sabbata and M. Gasperini, Lett. Nuovo Cimento 34, 337 (1982).
- [43] F. F. Mirabel and F. Rodriguez, Nature 371, 464 (1994).
- [44] J. Tingay et al., Nature 374, 141 (1995).
- [45] D. Baylin et al., IAU Comm. 6173 (1995).
- [46] P. Saari and K. Reivelt, Phys. Rev. Letters **23**, 343 (1999).
- [47] H. B. Nielsen and I. Picek, Nucl. Phys. B 211 269 (1983).
- [48] D. I. Blochintsev, Phys. Rev. Lett. 12, 272 (1964).
- [49] L. B. Redei, Phys.Rev. 145, 999 (1966).
- [50] D. Y. Kim, Hadronic J. 1, 1343 (1978).
- [51] A. K. Aringazin, Hadronic J. 12 71 (1989).
- [52] S. H. Aronson et al., Phys. Rev. D 28, 495 (1983).
- [53] N. Grossman et al., Phys. Rev. Lett. 59, 18 (1987).
- [54] G. Alexander et al., Phys. Lett. B 368, 244 (1996).
- [55] F. Cardone et al., J. Phys G. 18, L61 (1992).
- [56] F. Cardone et al., J. Phys. G. 18, L141 (1992).
- [57] Yu. Arestov, R. M. Santilli and V. Solovianov, Found. Phys. Lett. **11**, 483 (1998).
- [58] J. Lukierski et al., Phys. Lett. B **313**, 357 (1993). J. Lukierski et al., Phys. Lett. B **329**, 189 (1994).
- [59] B. Lořstad, Int. J. Mod. Phys. A **4**, 2861 (1989).
- [60] D. H. Boal et al. Rev. Mod. Phys. **62**, 553 (1990).
- [61] R. Adler et al., Z. Phys. C **63**, 541 (1994).
- [62] M. Gaspero et al., Phys. Lett. B **58**, 861 (1995).

- [63] 19. E. M. Santilli, *Hadronic J.* **15**, 1 and 81 (1992).
- [64] F. Cardone and R. Mignani, *JETP* **83**, 435 (1996).
- [65] F. Cardone, M. Gasperini and R. Mignani *Euop. Phys. J. C* **4**, 705 (1998).
- [66] UA1 collaboration, *Phys. Lett. B* **226**, 410 (1989).
- [67] J. W. Sulentic, in *Frontiers of Fundamental Physics*, M. Barone and F. Selleri, editors, Plenum [1994]
- [68] H. Arp, *Quasars, Redshifts, and Controversies*, Interstellar Media, Berkeley [1987] 31a.
- [69] H. Arp, in *Frontiers of Fundamental Physics*, M. Barone and F. Selleri, editors, Plenum [1994] 31b.
- [70] R. Mignani, *Physics Essay* 5, 531 (1992) 16c.
- [71] R. M. Santilli, in *Frontiers of Fundamental Physics*, M. Barone and F. Selleri, Editors, Plenum, New York [1995] 16.
- [72] Wikipedia, *Dark Matter*, http://en.wikipedia.org/wiki/Dark_matter
- [73] R. M. Santilli, *Galilean Electrodynamics* **17**, Special Issue 3, page 43 (2006).
- [74] R. M. Santilli, "Absence of dark matter from deviations of special relativity within the hyperdense medium inside stars, quasars and black holes," submitted for publication.
- [75] Wikipedia, *Supernovae*, <http://en.wikipedia.org/wiki/Supernova>
- [76] R. M. Santilli in *Proceedings of the International Meeting on Modified Theories of Gravitation and Cosmology*, Beer Sheva, Ben Gurion University, Israel, June 1997], E. I. Guendelman, Editor, Hadronic Press (1999).
- [77] R. M. Santilli, "Apparent absence of dark matter due to deviations from the speed of light ion interior of stars, quasars and black holes," submitted for publication.
- [78] S. Majid et al., *Phys. Lett. B* 334, 348 [1994] 17c.
- [79] R. M. Santilli, *Hadronic J. Suppl.* **4**, issue 1 (1988).
- [80] R. M. Santilli, *Hadronic J. Suppl.* **4**, issue 2 (1988).
- [81] R. M. Santilli, *Hadronic J. Suppl.* **4**, issue 3 (1988).
- [82] R. M. Santilli, *Hadronic J. Suppl.* **4**, issue 4 (1988).
- [83] R. M. Santilli, *Isodual Theory of Antimatter with Applications to Antigravity, Grand Unification and Cosmology*, Springer (2006)
- [84] The discovery of the top quark at FERMILAB http://www.fnal.gov/pub/inquiring/physics/discoveries/top_quark.html
- [85] CERN press reelease <http://press.web.cern.ch/Press/PressReleases/Releases1999/>
- [86] R. M. Santilli, *Found. Phys.* **32**, 1111 (2002)

- [87] Black holes
- [88] Santilli, "An intriguing legacy of Einstein, Fermi, Jordan and others: the possible invalidation of quark conjectures," *Found. Phys.* **11**, 383 (1981).
- [89] R. M. Santilli, *Ethical Probe of Einstein's Followers in the U.S.A.: An Insider's View*, Alpha Publishing, Newtonville, MA (1984), ISBN # 0-931753-00-7, available as free download in pdf format in the web site <http://www.scientificethics.org/IIGrandeGrido.htm>
- [90] R. M. Santilli, *Documentation of the Ethical Probe*, Volumes I, II and III, Alpha Publishing, Newtonville, MA (1986), available as free download in pdf format from the web site <http://www.scientificethics.org/IIGrandeGrido.htm>
- [91] H. Rutherford, *Proc. Roy. Soc. A* **97**, 374 (1920).
- [92] J. Chadwick *Proc. Roy. Soc. A* **136**, 692 (1932).
- [93] W. Pauli, *Handbruch der Physik*, Vol. 24 (Springer, Berlin, 1933).
- [94] E. Fermi, *Nuclear Physics* (University of Chicago Press, 1949).
- [95] R. M. Santilli, *Hadronic J.* **13**, 513 (1990).
- [96] R. M. Santilli, *Chinese J. Syst. Eng. and Electr. & Electr.* **6**, 177 (1996).
- [97] R. M. Santilli, *Found. Phys.* **37**, 670 (2007).
- [98] L. I. Schiff, H. Snider and J. Weinberg, *Phys. Rev.* **57**, 315 (1940).
- [99] R.M.Santilli, *The Physics of New Clean Energies and Fuels According to Hadronic Mechanics*, Special issue of the *Journal of New Energy*, 318 pages (1999).
- [100] R. M. Santilli, *Nuovo Cimento* **51**, 570 (1967).
- [101] E. R. Bagge, *World and Antiworld as Physical Reality* (Haag-Herchen, Frankfurt, 1994).
- [102] A. Franklin, *Are There Really Neutrinos?* (Westview Press, Boulder, 2000).
- [103] H. E. Wilhelm, *Hadronic Journal* **27**, 349 (2004).
- [104] R. L. Moessbauer, *J. de Physique C* **3**, 121 (1984).
- [105] J. Fanchi, *Hadronic J.* **28**, 717 (2006).
- [106] R. M. Santilli, *Hyperfine Interactions* **109**, 63 (1997) [3b];
- [107] R. M. Santilli, in *Proceedings of the XVIII Workshop on Hadronic Mechanics*, V. Dvoeglazov, T. Gill, P. Rowlands, and E. Trel, eds. (International Academic Press, to appear).
- [108] A. O. E. Animalu, *Hadronic J.* **17**, 379 (1994).
- [109] A. O. E. Animalu Animalu and R. M. Santilli, *Int. J. Quantum Chemistry* **29**, 175 (1995).
- [110] J. Dunning-Davies, *Exploding a Myth, Conventional Wisdom or Scientific Truth?* Horwood (2007).

- [111] R. M. Santilli, *Comm. Theor. Phys.* **4**, 1 (1995).
- [112] R. M. Santilli, *Hadronic J.* **17**, 311 (1994)
- [113] P. A. M. Dirac, *Proc. Royal Soc. A* **322**, 435 (1971)
- [114] P. A. M. Dirac, *Proc. Royal Soc. A* **328**, 1 (1972)
- [115] E. Corinaldesi and E. Strocchi, *Relativistic Wave Mechanics*, North Holland, New York (1963).
- [116] C. Borghi, C. Giorio and A. Dall'Olio, "Experimental evidence on the emission of neutrons from a cold hydrogen plasma," *Communications of CENUFPE*, Number 8 (1969) and 25 (1971).
- [117] C. Borghi, C. Giorio and A. Dall'Olio, "Experimental evidence on the emission of neutrons from cold hydrogen plasma," (Russian) *Phys. Atomic Nuclei*, **56**, 205 (or 939??? or 339???) (1993).
- [118] R. M. Santilli, "Apparent confirmation of don Borghi's experiment toward the synthesis of neutron from protons and electrons," to appear.
- [119] R. M. Santilli, *The Synthesis of the Neutron*, <http://www.neutronstructure.org/neutron-synthesis.htm>.
- [120] J. Phillips and R. Mils, *J. Applied Physics*, **96**, 3095 (2004).
- [121] L. Chatterjee, "Electrolysis in thin-film nickel coatings: mimicking supernova physics?" *Fus. Technol.*, **34**, 147 (1998).
- [122] R.L. Mills, "New energy and the cosmic hydrino sea," *Infinite Energy* **17**, 21 (1998).
- [123] J. Dufour, "Formation and properties of hydrex and deutex," *Fus. Technol.*, **24**, 205 (1993).
- [124] L. Daddi, "Proton-electron reactions as precursors of anomalous nuclear events," *Fus. Technol.*, **39**, 249 (2001).
- [125] R. M. Santilli, *Hadronic J.* *bf 17*, 311 91994).
- [126] S. Smith in *Proceedings of the International Symposium on New Energies*, M. Shawe et al., Editors, Association of New Energy, Denver, Colorado (1996).
- [127] N. F. Tsagas, A. Mystakidis, G. Bakos, and L. Seftelis, *Hadronic J.* **19**, 87 (1996).
- [128] R. M. Santilli, R. M. Santilli, in *Large Scale Collective Motion of Atomic Nuclei*, G. Giardina et al., Editors, World Scientific (1997).
- [129] R. M. Santilli, "Nuclear waste Recycling", <http://www.nuclearwasterecycling.com>
- [130] J. V. Kadeisvili, Chairman, Scientific Committee, *World Congress on Recycling Nuclear waste*, <http://www.i-b-r.org/ir00016.htm>

Chapter 7

ISO-, GENO-, AND HYPER-GRAND-UNIFICATIONS AND ISO-, GENO-, HYPER-COSMOLOGIES

7.1 ISO-, GENO-, AND HYPER-GRAND-UNIFICATION

7.1.1 The Role of Antimatter in Grand Unifications

As indicated earlier, no conclusive study on antimatter can be conducted without its consistent inclusion in *grand unifications* of gravitational [1–3] and electroweak interactions [4–7]. Vice versa, no grand unification can be considered scientifically valuable without the correct inclusion of antimatter because the latter has a profound impact in the very structure of a consistent grand unification.

All studies on grand unifications conducted until now have been essentially restricted to matter. When antimatter is included, the studies have to be enlarged to *two grand unifications*, one for matter and the other for antimatter with a correct anti-automorphic (or anti-isomorphic) interconnecting map.

Consequently, the inclusion of antimatter in grand unifications introduces severe restrictions on the admissible models, which restrictions are generally absent when antimatter is ignored and grand unifications are restricted to matter alone.

We shall, therefore, avoid the review of the very large number of structurally inconsistent grand unifications published since Einstein's times and leave to the interested reader their re-examination in light of the new advances of this volume.

An in depth study of grand unifications soon reveals the need of formulating antimatter at the purely classical level, the need for abandoning curvature, and the need for a geometric unification of special and general relativities as presented in preceding chapters. It is only at the level of these broader views on grand unifications that the isodual theory of antimatter emerges as inevitable.

Even though presented at the end of this monograph, the author initiated his studies on grand unification, constructed the needed broadening or modifications

of pre-existing methods, and then achieved an invariant, axiomatically consistent grand unification.

This process requires it two decades of research before the publication of the first paper on grand unification, a lapse of time illustrating the complexity of the problem, as known in any case by the failure of the large number of preceding attempts.

The reader should be aware that, in this section, we shall exclusively study *closed-isolated systems of electroweak and gravitational interactions in vacuum* that are treatable via the Lie-isotopic branch of hadronic mechanics and its isodual. Interior problems, such as those inclusive of the origin of gravitation, require the broader Lie-admissible branch of hadronic mechanics and their treatment will be merely indicated at the end of this section for development by interested readers.

7.1.2 Axiomatic Incompatibilities of General Relativity and Electroweak Interactions

The preceding efforts for a grand unification of gauge theories of electroweak interactions and gravitation as described by general relativity are afflicted by the following axiomatic incompatibilities, first presented in Ref. [9] of 1997 (see also the related papers [10,11]):

(1) **Incompatibilities due to antimatter:** electroweak theories are *bona fide* relativistic field theories, thus characterizing antimatter via *negative-energy* solutions, while general relativity characterizes antimatter via *positive-definite* energy-momentum tensors. This first incompatibility renders manifestly inconsistent all attempts at grand unification known to this author.¹

(2) **Incompatibilities due to curvature:** electroweak theories are essentially flat theories since they are formulated via *Minkowskian* axioms, while general relativity is centrally dependent on curvature since it is based on *Riemannian* axioms. This second incompatibility is another, independent, primary origin of the failure of the vast number of attempts at grand unification existing in the literature and carries profound implications, such as the extension to grand unification of the theorems of catastrophic inconsistencies of Section 1.4.

(3) **Incompatibilities due to spacetime symmetries:** electroweak interactions are based on the axioms of special relativity, thus verifying the fundamental *Poincaré symmetry* $P(3.1)$, while such a basic symmetry is absent in general relativity and is replaced by a generic covariance. This third incompatibility has

¹The indication of grand unifications inclusive of antimatter would be greatly appreciated.

additional profound implications for any consistent grand unification because either one abandons the basic symmetries of electroweak interactions in favor of an unknown covariance, or one abandons general relativity for a new theory admitting a universal symmetry.

(4) **Incompatibilities due to the lack of a Minkowskian limit of general relativity:** as it is well known [1–3], general relativity admits a well defined *Euclidean* limit under PPN approximation, but one century of studies have failed to identify a corresponding well defined *Minkowskian* limit. On the other side, electroweak interactions [4–7] are formulated on a Minkowski spacetime. This fourth incompatibility of the two interactions then emerges in a number of aspects, such as irreconcilable ambiguities in the identification of total conservation laws of grand unifications when inclusive of gravitational interactions.

(5) **Incompatibilities due to the nonunitary character of quantum gravity:** as it is also well known, electroweak theories are *operator* field theories with a *unitary* structure, thus having invariant prediction of numerical values permitting meaningful experimental verifications. By comparison, all quantum formulations of general relativity (see, e.g. Ref. [8] and references quoted therein) have a *nonunitary* structure. Besides evident, additional, independent inconsistencies in attempting to combine unitary and nonunitary theories, any attempt of grand unification along contemporary views in general relativity and quantum gravity is afflicted by the theorems of catastrophic inconsistencies of Section 1.4.

It is evident that no significant advance can be achieved in grand unifications without, firstly, a serious addressing of these inconsistencies and, secondly, without their resolution.

Recall that the theory of electromagnetic interactions, when (and only when) restricted to the *vacuum*², has a majestic mathematical and physical consistency that eventually propagated to unified theories of electromagnetic and weak interactions.

The view adopted in this monograph, identifiable in more details only now, is that, rather than abandoning the majestic beauty of electroweak theories, we abandon instead the popular views on gravitation of the 20-th century due to their catastrophic inconsistencies and, as a condition to achieve a consistent grand unification, we reconstruct gravitational theories in such a way to have *the same abstract axioms* of electroweak theories.

²It is well known by expert, but rarely spoken, that Maxwell's equations have no real physical value for the treatment of electromagnetism within physical media for countless reasons, some of which have been treated in Chapter 1. As an illustration, only to locally varying character of electromagnetic waves within physical media requires a radical revision of electromagnetism in the arena considered as a condition to pass from academic politics to real science.

7.1.3 Resolution of the Incompatibilities via Isotopies and Isodualities

In this chapter we present a resolution of the above incompatibilities first achieved by Santilli in Refs. [9] of 1997 (see also Refs. [10,11] following a number of rather complex and diversified scientific journeys that can be outlined as follows:

(A) Isotopies. The scientific journey to achieve a consistent grand unification started in 1978 with memoirs [12,13] for the classical and operator isotopies. A baffling aspect in the inclusion of gravity in unified gauge theories is their geometric incompatibility.

The view that motivated Refs. [12,13] is that the difficulties experienced in achieving a consistent grand unification are primarily due to *insufficiencies in their mathematical treatment*.

Stated in plain language, the view here considered is that, due to the complexity of the problem, the achievement of an axiomatic compatibility between gravitation and electroweak interactions requires a basically new mathematics, that is, basically new numbers, new spaces, new symmetries, etc.

Following first the verification of the lack of existence in the literature of a mathematics permitting the desired consistent grand unification, and following numerous attempts, the *only* possible new mathematics resulted to be that permitted by the *isotopies* as first proposed in Refs. [12,13], namely, a generalization of the conventional trivial unit +1 of electroweak theories into the most general possible, positive-definite unit with an unrestricted functional dependence on local variables, called *Santilli's isounit*,

$$I = +1 > 0 \quad \rightarrow \quad \hat{I} = \hat{I}^\dagger = I(x, v, \psi, \partial\psi, \dots) > 0, \quad (7.1.1)$$

and consequential compatible reconstruction of all main branches of mathematics.

The uniqueness of the isotopies is due to the fact that, *whether conventional or generalized, the unit is the basic invariant of any theory*. Therefore, the use of the unit for the generalization of pre-existing methods guarantees the preservation of the invariance so crucial for physical consistency (Sections 1.5.2 and 1.5.3).

Another aspect that illustrates the uniqueness of the isotopies for grand unifications is that *the positive-definiteness of the isounit guarantees the preservation of the abstract axioms of electroweak theories*, thus assuring axiomatic consistency of grand unification from the very beginning.

The general lines on isotopies presented in memoirs [12,13] of 1978 were then followed by laborious studies that reached mathematical and physical maturity only in memoir [14] of 1996, as outlined in Chapter 3 (see monographs [15] for a comprehensive presentation).

(B) Isodualities. The achievement of an axiomatically consistent grand unification for *matter* constitutes only *half* of the solution because, as stressed in Section 7.1.1, no grand unification can be considered physically significant without the consistent inclusion of antimatter.

The incompatibility of electroweak theories and general relativity for antimatter identified in Section 7.1.2 is only the symptom of deeper compatibility problems. As now familiar from the studies presented in this monograph, matter is treated at *all* levels, from Newtonian to electroweak theories, while antimatter is treated only at the level of *second quantization*.

Since there are serious indications that half of the universe could well be made up of antimatter (see Section 7.2), it is evident that a more effective theory of antimatter must apply at *all* levels.

Until such a scientific imbalance is resolved, any attempt at a grand unification can well prove to be futile.

Recall that charge conjugation in quantum mechanics is an *anti-automorphic map*. As a result, no classical theory of antimatter can possibly be axiomatically consistent via the mere change of the sign of the charge, because it must be an anti-automorphic (or, more generally, anti-isomorphic) image of that of matter in *all* aspects, including numbers, spaces, symmetries, etc.

The resolution of the above imbalance required a second laborious scientific journey that initiated with the proposal of the *isodual map* in memoirs [16] of 1985, here expressed for an arbitrary quantity

$$Q(x, v, \psi, \dots) \rightarrow Q^d = -Q^\dagger(-x^\dagger, -v^\dagger, -\psi^\dagger, -\partial\psi^\dagger, \dots), \quad (7.1.2)$$

proposal that was followed by various studies whose mathematical and physical maturity was only reached years later in memoir [14] of 1996, as reported in Chapters 2 and 3 (see also monographs [15] for a more general presentation).

To illustrate the difficulties, it is appropriate here to note that, following the presentation in papers [16] of 1985 of the main mathematical ideas, it took the author *nine years* before publishing their application to antimatter in paper [17] of 1994.

We are here referring to the original proposal of Refs. [16,17] of mapping isounit (7.1.1) for matter into an *negative-definite* nonsingular arbitrary unit, known today as *Santilli's isodual isounits*,

$$\hat{I}(x, \psi, \partial\psi, \dots) > 0 \rightarrow \hat{I}^d = -\hat{I}^\dagger(-x^\dagger, -\psi^\dagger, -\partial\psi^\dagger, \dots) < 0 \quad (7.1.3)$$

and its use for the characterization of antimatter at all levels, from Newtonian mechanics to second quantization.

The uniqueness of the isodual representation is given by the fact that isodualities are the *only* known liftings permitting the construction of a mathematic that is anti-isomorphic to the conventional (or isotopic) mathematics, as necessary for

a consistent representation of antimatter at all levels, while preserving the crucial invariance needed to avoid catastrophic inconsistencies.

(C) Poincaré-Santilli isosymmetry and its isoduals. The scientific journeys on isotopies and isodualities were only intended as pre-requisites for the construction of the *universal symmetry of gravitation for matter and, separately, for antimatter* in such a way to be locally isomorphic to the spacetime symmetry of electroweak interactions, the latter being an evident condition of consistency.

It is easy to see that, without the prior achievement of a new gravitation possessing an invariance, rather than the covariance of general relativity, any attempt at constructing a grand unification will prove to be futile in due time.

The complexity of the problem is illustrated by the fact that, not only gravitation for matter had to be reformulated in a form admitting a symmetry, but that symmetry had to be compatible with the basic Poincaré symmetry of electroweak theories [4–7]. Moreover, a dual compatible symmetry had to be achieved for the gravity of antimatter.

The latter problems called for a third laborious scientific journey on the *isotopies and isodualities of the Poincaré symmetry \hat{P} (3.1)*, today called the *Poincaré-Santilli isosymmetry and its isodual* outlined in Section 3.5 (see monographs [15] for comprehensive studies). These studies included:

- 1) The isotopies and isodualities of the Lorentz symmetry initiated with paper [18] of 1983 on the classical isotopies with the operator counterpart presented in paper [19] of the same year;
- 2) The isotopies and isodualities of the rotational symmetry first presented in papers [16]³;
- 3) The isotopies and isodualities of the $SU(2)$ -spin symmetry, first presented in paper [20] of 1993, and related implications for local realist, hidden variables and Bell's inequalities published in Ref. [21] of 1998;
- 4) The isotopies and isodualities of the Poincaré symmetry including the universal invariance of gravitation, first presented in paper [22] of 1993; and
- 5) The isotopies and isodualities of the spinorial covering of the Poincaré symmetry first presented in papers [23,24] of 1996.⁴

³Papers [16] on the lifting of the rotational symmetry were evidently written before paper [19] on the lifting of the Lorentz symmetry, but appeared in print only two years following the latter due to rather unreasonable editorial processing by various journals reported in Ref. [16], which processing perhaps illustrates the conduct of some (but not all) editors when facing true scientific novelty.

⁴Ref. [24], which is the most important reference of this entire monograph (because admitting all topics as particular cases), was rejected for years by all journals of Western Physical Societies because the paper included an *industrial* application currently receiving large investments by the industry — although not by academia, — consisting in the achievement of a numerical, exact and invariant representation of *all* characteristics of the neutron as a bound state of a proton and an electron according to Rutherford. In fact, the resolution of the historical difficulties of Rutherford's conception of the neutron permits the utilization of the large clean energy contained in the neutron's structure, via its stimulated decay

We are referring here to the reconstruction of the conventional symmetries with respect to an arbitrary nonsingular positive-definite unit (7.1.1) for the isotopies, and with respect to an arbitrary nonsingular negative-definite unit (7.1.3) for the isodualities.

This reconstruction yields the most general known nonlinear, nonlocal and noncanonical or nonunitary liftings of conventional symmetries, while the locally isomorphism for isotopies) (anti-isomorphism for isodualities) with the original symmetries is guaranteed by the positive-definiteness (negative-definiteness) of the generalized units.

One should be aware that the above structures required the prior step-by-step isotopies and isodualities of Lie's theory (enveloping associative algebras, Lie algebras, Lie groups, transformation and representation theories, etc.), originally proposed by Santilli in 1978 [12], studied in numerous subsequent works and today called the *Lie-Santilli isothory and its isodual* (see Section 3.2 for an outline and Refs. [15] for comprehensive studies).

It is evident that the Poincaré-Santilli isosymmetry and its isodual have fundamental character for these studies. One of their primary applications has been the achievement of the universal *symmetry* (rather than covariance) of all possible Riemannian line elements in their iso-Minkowskian representation [22]

$$ds'^2 = dx'^{\mu} \times g(x')_{\mu\nu} \times dx'^{\nu} \equiv dx^{\mu} \times g(x)_{\mu\nu} \times dx^{\nu} = ds^2, \quad (7.1.4)$$

Once the unit of gauge theories is lifted to represent gravitation, electroweak interactions will also obey the Poincaré-Santilli isosymmetry for matter and its isodual for antimatter, thus offering realistic hopes for the resolution of the most difficult problem of compatibility between gravitation and electroweak interactions, that for spacetime symmetries.

Perhaps unexpectedly, the fundamental spacetime symmetry of the grand unified theory of Refs. [9–11] is based on the *total symmetry of Dirac's equation*, here written with related spacetime and underlying unit (see Chapter 2 for details)

$$S_{tot} = \{SL(2.C) \times T(3.1) \times \mathcal{I}(1)\} \times \{SL^d(2.C^d) \times {}^d T^d(3.1) \times {}^d \mathcal{I}^d(1)\}, \quad (7.1.5a)$$

caused by a hard photon with a resonating frequency (numerically predicted by hadronic mechanics) that expels Rutherford's electron (the *isoelectron* with an isorenormalized mass generated by the nonlocal and non-Lagrangian interactions in the hyperdense medium inside the proton, see Chapter 6 and references quoted therein),

$$\gamma_{reson.} + n \rightarrow p^+ + e^- + \bar{\nu}.$$

Despite the undeniable mathematical consistency clear plausibility and evident large societal implications due to the need for new clean energies, Ref. [24] was rejected by all Western Physical Society without any credible scientific motivation because not aligned with organized interests in quantum mechanics and special relativity. Paper [24] was finally published in China in 1996. As a gesture of appreciation for this scientific democracy, the author organized in Beijing the 1997 International Workshop on Hadronic Mechanics (see the Proceedings of the Workshops on Hadronic Mechanics listed in the General Bibliography).

$$M_{tot} = \{M(x, \eta, R) \times S_{spin}\} \times \{M^d(x^d, \eta^d, R^d) \times^d S_{spin}^d\}, \quad (7.1.5b)$$

$$I_{tot} = \{I_{orb} \times I_{spin}\} \times \{I_{orb}^d \times^d I_{spin}^d\}. \quad (7.1.5c)$$

To understand the above occurrence, the reader should be aware that isodualities imply a new symmetry called *isoselfduality* (Section 2.1), given by the invariance under the isodual map (7.1.2).

Dirac's gamma matrices verify indeed this new symmetry (from which the symmetry itself was derived in the first place), i.e.,

$$\gamma_\mu \rightarrow \gamma_\mu^d = -\gamma_\mu^\dagger = \gamma_\mu. \quad (7.1.6)$$

Consequently, contrary to a popular belief throughout the 20-th century, the Poincaré symmetry *cannot* be the total symmetry of Dirac's equations, evidently because it is not isoselfdual.

For evident reasons of consistency, the total symmetry of Dirac's equation must also be isoselfdual as the gamma matrices are. This condition identifies the total symmetry (7.1.5a) because that symmetry is indeed isoselfdual.

To understand the dimensionality of symmetry (7.1.5a) one must first recall that isodual spaces are independent from conventional spaces. The doubling of the conventionally believed ten-dimensions of the Poincaré symmetry then yields *twenty* dimensions.

But relativistic invariants possess the novel *isotopic invariance* (3.5.27), i.e.,

$$\begin{aligned} (x^\nu \times \eta_{\mu\nu} \times x^\nu) \times I &\equiv [x^\nu \times (w^{-2} \times \eta)_{\mu\nu} \times x^\nu] \times (w^2 \times I) \\ &= (x^\nu \times \hat{\eta}_{\mu\nu} \times x^\nu) \times \hat{I}, \end{aligned} \quad (7.1.7)$$

with corresponding isotopic invariance of Hilbert's inner product

$$\begin{aligned} \langle \psi | \times | \psi \rangle \times I &\equiv \langle w^{-1} \times \psi | \times | w^{-1} \times \psi \rangle \times (w^2 \times I) \\ &= \langle \psi | \hat{\times} | \psi \rangle \times \hat{I}. \end{aligned} \quad (7.1.8)$$

Consequently, the conventional Poincaré symmetry has emerged as being *eleven dimensional* at both the classical and operator levels, as first presented by Santilli in Ref. [22] of 1993 and studied in Section 3.5.3. It then follows that *the total symmetry* (7.1.5a) *of Dirac's equations is twenty-two dimensional*.

The grand unification proposed in Refs. [9–11] is based on the axiomatic structure of the conventional Dirac's equations, not as believed throughout the 20-th century, but as characterized by isotopies and isodualities.

In particular, the grand unification here studied is permitted by the new isotopic invariances (7.1.7) and (7.1.8) that are hidden in relativistic invariants [21], thus assuring the operator compatibility of the grand unification, as we shall see.

The reader should not be surprised that the two new invariances (7.1.7) and (7.1.8) remained undetected throughout the 20-th century because their identification required the prior discovery of *new numbers*, first the numbers with arbitrary positive units, and then the additional new numbers with arbitrary negative units for invariances [25].

(D) Classical and operator isogravitation. After a number of (unpublished) attempts, the resolution of numerous inconsistencies of general relativity studied in Section 1.4, plus the inconsistencies for grand unifications, requested the *isotopic reformulation of gravitation*, today known as *Santilli's isogravitation*, first presented at the VII M. Grossman Meeting on General Relativity of 1996 [26], as reviewed in Section 3.5, essentially consisting in the factorization of any given (nonsingular and symmetric) Riemannian metric $g(x)$ into the Minkowskian metric η multiplied by a 4×4 -matrix \hat{T} ,

$$g(x) = \hat{T}_{Grav}(x) \times \eta, \quad (7.1.9)$$

and the reconstruction of gravitation with respect to the isounit

$$\hat{I}_{Grav}(x) = 1/\hat{T}_{Grav}(x), \quad (7.1.10)$$

thus requiring the isotopic reformulation of the totality of the mathematical and physical methods of general relativity.

Despite its simplicity, the implications of isogravitation are far reaching, such as:

- 1) The isotopic reformulation permits the achievement of the universal Poincaré-Santilli isoinvariance for all possible gravitational models;
- 2) The isotopic reformulation eliminates curvature for the characterization of gravity, and replaces it with *isoflatness*, thus achieving compatibility with the flatness of electroweak interactions;
- 3) The isotopic reformulation reconstructs unitarity on iso-Hilbert spaces over isofields via the identical reformulation of nonunitary transform at the foundations of hadronic mechanics (Chapter 3)

$$U \times U^\dagger \neq I \rightarrow \hat{U} \hat{\times} \hat{U}^\dagger = \hat{U}^\dagger \hat{\times} \hat{U} = \hat{I}_{Grav}, \quad (7.1.11)$$

where

$$U \times U^\dagger = \hat{I}, \quad \hat{U} = U \times \hat{T}_{Grav}^{1/2}, \quad (7.1.12)$$

thus providing the *only* known resolution of the catastrophic inconsistencies of Theorems 1.5.1 and 1.5.2.

Above all, isogravitation achieved the first and only known, axiomatically consistent operator formulation of gravitation provided by relativistic hadronic mechanics of Section 3.5, as first presented in Ref. [27] of 1997.

In fact, gravity is merely imbedded in the *unit* of relativistic operator theories. Since the gravitational isounit is positive-definite from the nonsingular and symmetric character of the metric $g(x)$ in factorization (7.1.9), the abstract axioms of operator isogravity are the conventional axioms of relativistic quantum mechanics, only subjected to a broader realization.

The preservation of conventional relativistic axioms then assures the achievement, for the first time as known by the author, of a consistent operator formulation of gravitation.⁵

(E) Geometric unification of special and general relativities. The resolution of the problems caused by lack of any Minkowskian limit of general relativity requested additional studies. After a number of (unpublished) attempts, the only possible solution resulted to be a geometric unification of special and general relativities, first presented in Ref. [28], in which the two relativities are characterized

by the same abstract axioms and are differentiated only by their realization of the basic unit. The trivial realization $I = \text{Diag.}(1, 1, 1, 1)$ characterizes special relativity, and broader realization (7.1.10) characterizes general relativity.

The latter final efforts requested the construction *ab initio* of a new geometry, today known as *Minkowski-Santilli isogeometry* [28] in which the abstract axioms are those of the Minkowskian geometry, including the abstract axiom of flatness necessary to resolve the catastrophic inconsistencies of Section 1.4, yet the new geometry admits the entire mathematical formalist of the Riemannian geometry, including covariant derivatives, Christoffel's symbols, etc. (see Section 3.2 for an outline and monographs [15] for comprehensive studies).

The important point is that at the limit

$$\lim \hat{I}_{Grav}(x) \rightarrow I, \quad (7.1.13)$$

the Minkowskian geometry and conventional special relativity are recovered identically and uniquely.

The reader should be aware that the grand unification presented in this section is centrally dependent on the Minkowski-Santilli isogeometry, the Poincaré-Santilli isosymmetry, and the isotopic formulation of gravitation. Their knowledge is a necessary pre-requisite for the technical understanding of the following sections.

⁵Note that the use of the words “quantum gravity” for operator formulation of gravitation, whether conventional or characterized by the isotopies, would be merely political. This is due to the fact that, on serious scientific grounds, the term “quantum” can only be referred to physical conditions admitting a quantized emission and absorption of energy as occurring in the structure of the hydrogen atom. By comparison, no such quantized orbits are possible for operator theories of gravity, thus rendering nonscientific its characterization as “quantum gravity”. Ironically, the editor of a distinguished physics journal expressed interest in publishing a paper on “operator isogravity” under the condition of being called “quantum gravity”, resulting in the necessary withdrawal of the paper by the author so as not to reduce fundamental physical inquiries to political compromises.

7.1.4 Isotopic Gauge Theories

The isotopies of gauge theories were first studied in the 1980's by Gasperini [29], followed by Nishioka [30], Karajannis and Jannussis [31] and others, and ignored thereafter for over a decade.

These studies were defined on conventional spaces over conventional fields and were expressed via the conventional differential calculus. As such, they are not invariant, as it became shown in memoirs [32], thus suffering of the catastrophic inconsistencies of Theorem 1.5.2.

Refs. [9–11] presented, apparently for the first time, the *invariant isotopies of gauge theories*, or *isogauge theories* for short, and their isoduals, those formulated on isospaces over isofields and characterized by the isodifferential calculus of memoir [14]. For completeness, let us recall that the latter theories are characterized by the following methods:

(1) **Isofields** [25] of isoreal numbers $\hat{R}(\hat{n}, \hat{+}, \hat{\times})$ and isocomplex numbers $\hat{C}(\hat{c}, \hat{+}, \hat{\times})$ with: additive isounit $\hat{0} = 0$; generalized multiplicative isounit \hat{I} given by Eq. (7.1.9); elements, isosum, isoproduct and related generalized operations,

$$\hat{a} = a \times \hat{I}, \quad \hat{a} \hat{+} \hat{b} = (a + b) \times \hat{I}, \quad (7.1.14a)$$

$$\hat{a} \hat{\times} \hat{b} = \hat{a} \times \hat{T} \times \hat{b} = (a \times b) \times \hat{I}, \quad (7.1.14b)$$

$$\hat{a}^{\hat{n}} = \hat{a} \hat{\times} \hat{a} \hat{\times} \dots \hat{\times} \hat{a}, \quad (7.1.14c)$$

$$\hat{a}^{1/2} = a^{1/2} \times \hat{I}^{1/2}, \quad \hat{a} \hat{/} \hat{b} = (\hat{a} / \hat{b}) \times \hat{I}, \text{ etc.} \quad (7.1.14d)$$

(2) **Isominkowski spaces** [18] $\hat{M} = \hat{M}(\hat{x}, \hat{\eta}, \hat{R})$ with isocoordinates $\hat{x} = x \times \hat{I} = \{x^\mu\} \times \hat{I}$, isometric $\hat{N} = \hat{\eta} \times \hat{I} = [\hat{T}(x, \dots) \times \eta] \times \hat{I}$, and *isointerval* over the isoreals \hat{R}

$$\begin{aligned} (\hat{x} - \hat{y})^{\hat{2}} &= [(\hat{x} - \hat{y})^\mu \hat{\times} \hat{N}_{\mu\nu} \hat{\times} (\hat{x} - \hat{y})^\nu] \\ &= [(x - y)^\mu \times \hat{\eta}_{\mu\nu} \times (x - y)^\nu] \times \hat{I}, \end{aligned} \quad (7.1.15)$$

equipped with *Kadeisvili isocontinuity* [33] and the *isotopology* developed by G. T. Tsagas and D. S. Surlas [34], R. M. Santilli [14], R. M. Falc3n Ganfornina and J. N3n3ez Vald3s [35,36] (see also Aslander and Keles [37]). A more technical formulation of the isogauge theory can be done via the isobundle formalism on isogeometries.

(3) **Isodifferential calculus** [14] characterized by the following isodifferentials

$$\hat{d}\hat{x}^\mu = \hat{I}_\nu^\mu \times d\hat{x}^\nu, \quad (7.1.16a)$$

$$\hat{d}\hat{x}_\mu = \hat{T}_\mu^\nu \times d\hat{x}_\nu, \quad (7.1.16b)$$

and isoderivatives

$$\hat{\partial}_\mu \hat{f} = \hat{\partial} \hat{f} / \hat{\partial} \hat{x}^\mu = (\hat{T}_\mu^\nu \times \partial_\nu f) \times \hat{I}, \quad (7.1.17a)$$

$$\hat{\partial}^\mu \hat{f} = (\hat{I}_\nu^\mu \times \partial_\nu f) \times \hat{I}, \quad \hat{\partial} \hat{x}^\mu \hat{\partial} \hat{x}^\nu = \hat{\delta}_\nu^\mu = \hat{\delta}_\nu^\mu \times \hat{I}, \text{ etc.} \quad (7.1.17b)$$

where one should note the inverted use of the isounit and isotopic element with respect to preceding formulations.

(4) Isofunctional isoanalysis [15], including the reconstruction of all conventional and special functions and transforms into a form admitting of \hat{I}_{Grav} as the left and right unit. Since the iso-Minkowskian geometry preserves the Minkowskian axioms, it allows the preservation of the notions of straight and intersecting lines, thus permitting the reconstruction of trigonometric and hyperbolic functions for the Riemannian metric $g(x) = \hat{T}(x) \times \eta$.

(5) Iso-Minkowskian geometry [28], i.e., the geometry of isomanifolds \hat{M} over the isoreals \hat{R} , that satisfies all abstract Minkowskian axioms because of the joint liftings

$$\eta \rightarrow \hat{\eta} = T(x, \dots) \times \eta, \quad (7.1.18a)$$

$$I \rightarrow \hat{I} = T^{-1}, \quad (7.1.18b)$$

while preserving the machinery of Riemannian spaces as indicated earlier, although expressed in terms of the isodifferential calculus.

In this new geometry *Riemannian* line elements are turned into identical *Minkowskian* forms via the embedding of gravity in the differentials, e.g., for the Schwarzschild exterior metric we have the iso-Minkowskian reformulation (Ref. [28], Eqs. (2.57)), where the spacetime coordinates are assumed to be covariant,

$$\hat{d}\hat{s} = \hat{d}\hat{r}^2 \hat{+} \hat{r}^2 \hat{\times} (\hat{d}\hat{\theta}^2 \hat{+} \text{isosin}^2 \hat{\theta}) \hat{-} \hat{d}\hat{t}^2, \quad (7.1.19a)$$

$$\hat{d}\hat{r} = \hat{T}_r \times d\hat{r}, \quad \hat{d}\hat{t} = \hat{T}_t \times dt, \quad (7.1.19b)$$

$$\hat{T}_r = (1 - 2 \times M/r)^{-1}, \quad \hat{T}_t = 1 - 2 \times M/r. \quad (7.1.19c)$$

(6) Relativistic hadronic mechanics [15] characterized by the *iso-Hilbert space* $\hat{\mathcal{H}}$ with *isoinner product and isonormalization* over \hat{C}

$$\langle \hat{\phi} | \hat{\times} | \hat{\psi} \rangle \times \hat{I}, \quad \langle \hat{\psi} | \hat{\times} | \hat{\psi} \rangle = \hat{I}. \quad (7.1.20)$$

Among various properties, we recall that: the *iso-Hermiticity* on $\hat{\mathcal{H}}$ coincides with the conventional Hermiticity (thus, all conventional observables remain observables under isotopies); the isoeigenvalues of iso-Hermitean operators are real and conventional (because of the identities

$$\hat{H} \hat{\times} | \hat{\psi} \rangle = \hat{E} \hat{\times} | \hat{\psi} \rangle = E \times | \hat{\psi} \rangle; \quad (7.1.21)$$

the condition of *isounitariness* on $\hat{\mathcal{H}}$, over \hat{C} is given by

$$\hat{U} \hat{\times} \hat{U}^\dagger = \hat{U}^\dagger \hat{\times} \hat{U} = \hat{I}, \quad (7.1.22)$$

(see memoir [27] for details).

(7) The Lie-Santilli isothory [12] with: conventional (ordered) basis of generators $X = (X_k)$, and parameters $w = (w_k)$, $k = 1, 2, \dots, n$, only formulated in isospaces over isofields with a common isounit; universal enveloping isoassociative algebras $\hat{\xi}$ with infinite-dimensional basis characterized by the isotopic Poincare'-Birkhoff-Witt theorem [12]

$$\hat{I}, \hat{X}_i \hat{\times} \hat{X}_j, (i \leq j), \hat{X}_i \hat{\times} \hat{X}_j \times \hat{X}_k, (i \leq j \leq k, \dots) \tag{7.1.23}$$

Lie-Santilli subalgebras [12]

$$[\hat{X}_i, \hat{X}_j] = \hat{X}_i \hat{\times} \hat{X}_j - \hat{X}_j \hat{\times} \hat{X}_i = \hat{C}_{ij}^k(x, \dots) \hat{\times} \hat{X}_k, \tag{7.1.24}$$

where the \hat{C} 's are the structure disfunctions; and isogroups characterized by isoexponentiation on $\hat{\xi}$ with structure [12]

$$\hat{e}^{\hat{X}} = \hat{I} \hat{+} \hat{X} / \hat{1}! \hat{+} \hat{X} \hat{\times} \hat{X} / \hat{2}! \hat{+} \dots = (e^{\hat{X} \times \hat{T}}) \times \hat{I} = \hat{I} \times (e^{\hat{T} \times \hat{X}}). \tag{7.1.25}$$

Despite the isomorphism between isotopic and conventional structures, the lifting of Lie's theory is nontrivial because of the appearance of the matrix \hat{T} with nonlinear integrodifferential elements in the very *exponent* of the group structure, Eqs. (7.1.25).

To avoid misrepresentations, one should keep in mind that the isotopies of Lie's theory *were not* proposed to identify "new Lie algebras" (an impossible task since all simple Lie algebras are known from Cartan's classification), but to construct instead the most general possible nonlinear, nonlocal and noncanonical or nonunitary "realizations" of known Lie algebras.

(8) Isolinerity, isolocality and isocanoncity or isounitarity. Recall from lifting (7.1.25) that isosymmetries have the most general possible nonlinear, nonlocal and noncanonical or nonunitary structure. A main function of the isotopies is that of reconstructing linearity, locality and canonicity or unitarity on isospaces over isofields, properties called *isolinerity, isolocality and isocanoncity or isounitarity*. These are the properties that permit the bypassing of the theorems of catastrophic inconsistencies of Section 1.5.

As a result, the use of the conventional *linear* transformations on M over R , $X' = A(w) \times x$ violates *isolinerity* on \hat{M} over \hat{R} .

In general, *any* use of conventional mathematics for isotopic theories leads to a number of inconsistencies which generally remain undetected by nonexperts in the field.⁶

⁶The use of conventional mathematics for isothories would be the same as elaborating Balmer's quantum spectral lines in the hydrogen atoms with isofunctional analysis, resulting in evident major inconsistencies.

(9) Isogauge theories [9–11]. They are characterized by an n -dimensional connected and non-isoabelian isosymmetry \hat{G} with: basic n -dimensional isounit (4.1.9); iso-Hermitean generators \hat{X} on an iso-Hilbert space $\hat{\mathcal{H}}$ over the isofield $\hat{C}(\hat{c}, \hat{+}, \hat{\times})$; universal enveloping associative algebra $\hat{\xi}$ with infinite isobasis (7.1.23); isocommutation rules (7.1.24); isogroup structure

$$\hat{U} = \hat{e}^{-i \times X_k \times \theta(x)_k} = (e^{-i \times X_k \times \hat{T} \times \theta(x)_k}) \times \hat{I}, \quad \hat{U}^\dagger \hat{\times} \hat{U} = \hat{I}, \quad (7.1.26)$$

where one should note the appearance of the gravitational isotopic elements in the *exponent* of the isogroup, and the parameters $\theta(x)_k$ now depend on the iso-Minkowski space; isotransforms of the isostates on $\hat{\mathcal{H}}$

$$\hat{\psi}' = \hat{U} \hat{\times} \hat{\psi} = (e^{-i \times X_k \times \hat{T}(x, \dots) \times \theta(x)_k}) \times \hat{\psi}; \quad (7.1.27)$$

isocovariant derivatives [28]

$$\hat{D}_\mu \hat{\psi} = (\hat{\partial}_\mu - i \hat{\times} \hat{g} \hat{\times} \hat{A}(\hat{x})_\mu^k \hat{\times} \hat{X}_k) \hat{\times} \hat{\psi}; \quad (7.1.28)$$

iso-Jacobi identity

$$[\hat{D}_\alpha, [\hat{D}_\beta, \hat{D}_\gamma]] \hat{+} [\hat{D}_\beta, [\hat{D}_\gamma, \hat{D}_\alpha]] \hat{+} [\hat{D}_\gamma, [\hat{D}_\alpha, \hat{D}_\beta]] = 0, \quad (7.1.29)$$

where g and $\hat{g} = g \times \hat{I}$ are the conventional and isotopic coupling constants, $A(x)_\mu^k \times X_k$ and $\hat{A}(\hat{x})_\mu^k \hat{\times} \hat{X}_k = [A(x)_\mu^k \times X_k] \times \hat{I}$ are the gauge and isogauge potentials; isocovariance

$$(\hat{D}_\mu \hat{\psi})' = (\hat{\partial}_\mu \hat{U}) \hat{\times} \hat{\psi} \hat{+} \hat{U} \hat{\times} (\hat{\partial}_\mu \hat{\psi}) \hat{-} i \hat{\times} \hat{g} \hat{\times} \hat{A}'(\hat{x})_\mu \hat{\times} \hat{\psi} = \hat{U} \hat{\times} \hat{D}_\mu \hat{\psi}, \quad (7.1.30a)$$

$$\hat{A}(\hat{x})'_\mu = -\hat{g}^{-1} \hat{\times} [\hat{\partial}_\mu \hat{U}(\hat{x})] \hat{\times} \hat{U}(\hat{x})^{-1}, \quad (7.1.30b)$$

$$\hat{\delta} \hat{A}(\hat{x})_\mu^k = -\hat{g}^{-1} \hat{\times} \hat{\partial}_\mu \hat{\theta}(\hat{x})^k \hat{+} \hat{C}_{ij}^k \hat{\times} \hat{\theta}(\hat{x})^i \hat{\times} \hat{A}(\hat{x})_\mu^j, \quad (7.1.30c)$$

$$\hat{\delta} \hat{\psi} = -i \hat{\times} \hat{g} \hat{\times} \hat{\theta}(\hat{x})^k \hat{\times} \hat{X}_k \hat{\times} \hat{\psi}; \quad (7.1.30d)$$

non-isoabelian iso-Yang-Mills fields

$$\hat{F}_{\mu\nu} = i \hat{\times} \hat{g}^{-1} \hat{\times} [\hat{D}_\mu, \hat{D}_\nu] \hat{\psi}, \quad (7.1.31a)$$

$$\hat{F}_{\mu\nu}^k = \hat{\partial}_\mu \hat{A}_\nu^k \hat{-} \hat{\partial}_\nu \hat{A}_\mu^k \hat{+} \hat{g} \hat{\times} \hat{C}_{ij}^k \hat{\times} \hat{A}_\mu^i \hat{\times} \hat{A}_\nu^j; \quad (7.1.31b)$$

related isocovariance properties

$$\hat{F}_{\mu\nu} \rightarrow \hat{F}'_{\mu\nu} = \hat{U} \hat{\times} \hat{F}_{\mu\nu} \hat{\times} \hat{U}^{-1}, \quad (7.1.32a)$$

$$Isotrace(\hat{F}_{\mu\nu'} \hat{\times} \hat{F}^{\mu\nu'}) = Isotrace(\hat{F}_{\mu\nu} \hat{\times} \hat{F}^{\mu\nu}), \quad (7.1.32b)$$

$$[\hat{D}_\alpha, \hat{F}_{\beta\gamma}] \hat{+} [\hat{D}_\beta, \hat{F}_{\gamma\alpha}] \hat{+} [\hat{D}_\gamma, \hat{F}_{\alpha\beta}] \equiv 0; \tag{7.1.32c}$$

derivability from the isoaction

$$\hat{S} = \int \hat{d}^4 \hat{x} (-\hat{F}_{\mu\nu} \hat{\times} \hat{F}^{\mu\nu} \hat{\int} \hat{4}) = \int \hat{d}^4 \hat{x} (-\hat{F}_{\mu\nu}^k \hat{\times} \hat{F}_k^{\mu\nu} \hat{\int} \hat{4}), \tag{7.1.33}$$

where $\hat{\int} = \int \times \hat{I}$, plus all other familiar properties in isotopic formulation.

The *isodual isogauge theory*, first proposed in Refs. [9–11], is the image of the preceding theory under the isodual map (7.1.2) when applied to the totality of quantities and their operations.

The latter theory is characterized by the isodual isogroup \hat{G}^d with isodual isounit

$$\hat{I}_{Grav}^d = -\hat{I}_{Grav}^\dagger = -\hat{I}_{Grav} = -1/\hat{T}_{Grav} < 0. \tag{7.1.34}$$

The elements of the base fields

$$\hat{R}^d(\hat{n}^d, \hat{+}^d, \hat{\times}^d), \tag{7.1.35}$$

are given by the isodual isoreal numbers

$$\hat{n}^d = -\hat{n} = -n \times \hat{I}, \tag{7.1.36}$$

and those of the field

$$\hat{C}^d(\hat{c}^d, \hat{+}^d, \hat{\times}^d), \tag{7.1.37}$$

are the isodual isocomplex numbers

$$\hat{c}^d = -(c \times \hat{I})^\dagger = (n_1 - i \times n_2) \times \hat{I}^d = (-n_1 + i \times n_2) \times \hat{I}. \tag{7.1.38}$$

The carrier spaces are the isodual iso-Minkowski spaces $\hat{M}^d(\hat{x}^d, -\hat{\eta}^d, \hat{R}^d)$ on \hat{R}^d and the isodual iso-Hilbert space \mathcal{H}^d on \hat{C}^d with isodual isostates and isodual isoinner product

$$|\hat{\psi} \rangle^d = -|\hat{\psi} \rangle^{\dagger} = -\langle \psi |, \tag{7.1.39a}$$

$$\langle \hat{\phi} |^d \times \hat{T}^d \times |\hat{\psi} \rangle^d \times \hat{I}^d. \tag{7.1.39b}$$

It is instructive to verify that all eigenvalues of isodual iso-Hermitian operators are *negative – definite* (when projected in our space-time),

$$\hat{H}^d \hat{\times}^d |\hat{\psi} \rangle^d = \langle \psi | \times (-E). \tag{7.1.40}$$

\hat{G}^d is characterized by the isodual Lie-Santilli isothory with isodual generators $\hat{X}^d = -\hat{X}$, isodual isoassociative product

$$\hat{A}^d \hat{\times}^d \hat{B}^d = \hat{A}^d \times \hat{T}^d \times \hat{B}^d, \quad \hat{T}^d = -\hat{T}, \tag{7.1.41}$$

and related isodual isoenveloping and Lie-Santilli isoalgebra.

The elements of \hat{G}^d are the isodual isounitary isooperators

$$\hat{U}^d(\hat{\theta}^d(\hat{x}^d)) = -\hat{U}^\dagger(-\hat{\theta}(-\hat{x})). \quad (7.1.42)$$

In this way, the isodual isogauge theory is seen to be an anti-isomorphic image of the preceding theory, as desired.

It is an instructive exercise for the reader interested in learning the new techniques to study first the isodualities of the *conventional* gauge theory (rather than of their isotopies), and show that they essentially provide a mere reinterpretation of the usually discarded, advanced solutions as characterizing antiparticles.

Therefore, in the isoselfdual theory with total gauge symmetry $\hat{G} \times \hat{G}^d$, isotopic retarded solutions are associated with particles and advanced isodual solutions are associated with antiparticles.

No numerical difference is expected in the above reformulation because, as shown in Chapter 3, isotopies preserve not only the original axioms but also the original numerical value (when constructed properly).

It is also recommendable for the interested reader to verify that the isotopies are indeed equivalent to charge conjugation for all massive particles, with the exception of the photon (see Section 2.3). In fact, isodual theories predict that the antihydrogen atom emits a new photon, tentatively called by this author the *isodual photon* [38], that coincides with the conventional photon for all possible interactions, thus including electroweak interactions, *except gravitation*. This indicates that the isodual map is inclusive of charge conjugation for massive particles, but it is broader than the latter.

Isodual theories in general, thus including the proposed grand unification, predict that all *stable* isodual particles, such as the isodual photon, the isodual electron (positron), the isodual proton (antiproton) and their bound states (such as the antihydrogen atom), experience *antigravity* in the field of the Earth (defined as the reversal of the sign of the curvature tensor).

If confirmed, the prediction may offer the possibility in the future to ascertain whether far away galaxies and quasars are made-up of matter or of antimatter.

We finally note that isomathematics is a particular case of the broader *genomathematics*, also introduced for the first time in Refs. [12] of 1978 (see Chapter 4), which occurs for non-Hermitian generalized units and is used for an axiomatization of irreversibility.

In turn, genomathematics is a particular case of the *hypermathematics*, that occurs when the generalized units are given by ordered *sets* of non-Hermitian quantities and is used for the representation of multivalued complex systems (e.g. biological entities) in irreversible conditions.

Evidently both the genomathematics and hypermathematics admit an anti-isomorphic image under isoduality (see also Chapter 4).

In conclusion the methods outlined in this note permit the study of *seven* liftings of conventional gauge theories [9–11]:

(1) The *isodual gauge theories* for the treatment of antimatter without gravitation in vacuum;

(2,3) The *isogauge theories and their isoduals*, for the inclusion of gravity for matter and antimatter in reversible conditions in vacuum (exterior gravitational problem);

(4,5) The *genogauge theories and their isoduals*, for the inclusion of gravity for matter and antimatter in irreversible interior conditions (interior gravitational problems); and

(6,7) the *hypergauge theories and their isoduals*, for multivalued and irreversible generalizations.

For brevity this section is restricted to theories of type (1), (2), (3). The development of the remaining genotopies of gauge theories is left to interested readers.

7.1.5 Iso-, Geno- and Hyper-Grand-Unifications

In this section we review the *Iso-Grand-Unification* (IGU) with the inclusion of electroweak and gravitational interactions, first submitted in Refs. [9–11] via the 22-dimensional total isoselfdual isosymmetry given by isosymmetry (3.5.28) and its isodual

$$\begin{aligned} \hat{S}_{tot} &= (\hat{\mathcal{P}}(3.1) \hat{\times} \hat{G}) \times (\hat{\mathcal{P}}(3.1)^d \hat{\times}^d \hat{G}^d) = \\ &= [\hat{S}L(2, \hat{C}) \hat{\times} \hat{T}(3.1) \hat{\times} \hat{\mathcal{I}}(1)] \times [\hat{S}L^d(2, \hat{C}^d) \hat{\times}^d \hat{T}^d(3.1) \hat{\times}^d \hat{\mathcal{I}}^d(1)], \end{aligned} \quad (7.1.43)$$

where $\hat{\mathcal{P}}$ is the Poincaré-Santilli isosymmetry [22] in its isospinorial realization [24], \hat{G} is the isogauge symmetry of the preceding section and the remaining structures are the corresponding isoduals.

Without any claim of a final solution, it appears that the proposed IGU does indeed offer realistic possibilities of resolving the axiomatic incompatibilities (1)–(5) of Section 7.1.2 between gravitational and electroweak interactions.

In fact, IGU represents gravitation in a form geometrically compatible with that of the electroweak interactions, represents antimatter at all levels via negative-energy solutions, and characterizes both gravitation as well as electroweak interactions via the universal Poincaré-Santilli isosymmetry.

It should be indicated that we are referring here to the *axiomatic* consistency of IGU. In regard to the *physical* consistency we recall that isotopic liftings preserve not only the original axioms, but also the original numerical values [15].

As an example, the image in iso-Minkowskian space over the isoreals of the light cone, the isolight cone, not only is a perfect cone, but a cone with the original characteristic angle, thus preserving the speed of light in vacuum as the maximal causal speed in iso-Minkowskian space.

This peculiar property of the isotopies implies the expectation that the proposed Iso-Grand-Unification preserves the numerical results of electroweak interactions.

The reader should be aware that the methods of the recent memoir [27] permit a truly elementary, explicit construction of the proposed IGU.

As well known, the transition from the Minkowskian metric η to Riemannian metrics $g(x)$ is a *noncanonical transform* at the classical level, and, therefore, at the operator level.

The method herein considered for turning a gauge theory into an IGU consists in the following representation of the selected gravitational model, e.g., Schwarzschild's model:

$$g(x) = T(x) \times \eta, \quad (7.1.44a)$$

$$I(x) = U \times U^\dagger = 1/\hat{T} = \text{Diag.}[(1 - 2 \times M/r) \times \text{Diag.}(1, 1, 1), (1 - 2 \times M/r)^{-1}], \quad (7.1.44b)$$

and then subjecting the *totality* of the gauge theory to the nonunitary transform $U \times U^\dagger$.

The method then yields: the isounit

$$I \rightarrow \hat{I} = U \times I \times U^\dagger; \quad (7.1.45)$$

the isonumbers

$$a \rightarrow \hat{a} = U \times a \times U^\dagger = a \times (U \times U^\dagger) = a \times \hat{I}, \quad a = n, c; \quad (7.1.46)$$

the isoproduct with the correct expression and Hermiticity of the isotopic element,

$$\begin{aligned} A \times B &\rightarrow U \times (A \times B) \times U^\dagger = \\ &= (U \times A \times U^\dagger) \times (U \times U^\dagger)^{-1} \times (U \times B \times U^\dagger) = \\ &= \hat{A} \times \hat{T} \times \hat{B} = \hat{A} \hat{\times} \hat{B}; \end{aligned} \quad (7.1.47)$$

the correct form of the iso-Hilbert product on \hat{C} ,

$$\begin{aligned} \langle \phi | \times | \psi \rangle &\rightarrow U \times \langle \phi | \times | \psi \rangle \times U^\dagger = \\ &= (\langle \psi | \times U^\dagger) \times (U \times U^\dagger)^{-1} \times (U \times | \psi \rangle) \times (U \times U^\dagger) = \\ &= \langle \hat{\phi} | \times \hat{T} \times | \hat{\psi} \rangle \times \hat{I}; \end{aligned} \quad (7.1.48)$$

the correct Lie-Santilli isoalgebra

$$A \times B - B \times A \rightarrow \hat{A} \hat{\times} \hat{B} - \hat{B} \hat{\times} \hat{A}; \quad (7.1.49)$$

the correct isogroup

$$U \times (e^X) \times U^\dagger = (e^{X \times \hat{T}}) \times \hat{I}, \quad (7.1.50)$$

the Poincaré-Santilli isosymmetry $\mathcal{P} \rightarrow \hat{\mathcal{P}}$, and the isogauge group $G \rightarrow \hat{G}$.

It is then easy to verify that the emerging IGU is indeed invariant under all possible additional nonunitary transforms, provided that, for evident reasons of consistency, they are written in their identical isounitary form,

$$W \times W^\dagger = \hat{I}, \quad (7.1.51a)$$

$$W = \hat{W} \times \hat{I}^{1/2}, W \times W^\dagger = \hat{W} \hat{\times} \hat{W}^\dagger = \hat{W}^\dagger \hat{\times} \hat{W} = \hat{I}. \quad (7.1.51b)$$

In fact, we have the invariance of the isounit

$$\hat{I} \rightarrow \hat{I}' = \hat{W} \hat{\times} \hat{I} \hat{\times} \hat{W}^\dagger = \hat{I}, \quad (7.1.52)$$

the invariance of the isoproduct

$$\hat{A} \hat{\times} \hat{B} \rightarrow \hat{W} \hat{\times} (\hat{A} \hat{\times} \hat{B}) \hat{\times} \hat{W}^\dagger = \hat{A}' \hat{\times} \hat{B}', \text{ etc.} \quad (7.1.53)$$

Note that the isounit is *numerically* preserved under isounitary transforms, as it is the case for the conventional unit I under unitary transform, and that the selection of a nonunitary transform $W \times W^\dagger = \hat{I}'$ with value different from \hat{I} evidently implies the transition to a different gravitational model.

Note that the lack of implementation of the above nonunitary-isounitary lifting to only *one* aspect of the original gauge theory (e.g., the preservation of the old numbers or of the old differential calculus) implies the loss of the invariance of the theory [32].

The assumption of the negative-definite isounit $\hat{I}^d = -(U \times U^\dagger)$ then yields the isodual component of the IGU.

Note finally that diagonal realization (7.1.44) has been assumed mainly for simplicity. In general, the isounit is positive-definite but *nondiagonal* 4×4 -dimensional matrix. The Schwarzschild metric can then be more effectively represented in its isotropic coordinates as studied, e.g. in Ref. [39], pp. 196–199).

In closing, the most significant meaning of IGU is that *gravitation has always been present in unified gauge theories. It did creep-in un-noticed because embedded where nobody looked for, in the “unit” of gauge theories.*

In fact, the isogauge theory of Section 7.1.4 coincides with the conventional theory at the abstract level to such an extent that we could have presented IGU with exactly the same symbols of the conventional gauge theories without the “hats”, and merely subjecting the same symbols to a more general realization.

Also, the isounit representing gravitation as per rule (7.1.9) verifies all the properties of the conventional unit I of gauge theories,

$$\hat{I}^{\hat{n}} = \hat{I}, \quad \hat{I}^{\hat{1}/2} = \hat{I}, \quad (7.1.54a)$$

$$d\hat{I}/dt = \hat{I} \hat{\times} \hat{H} - \hat{H} \hat{\times} \hat{I} = \hat{H} - \hat{H} = 0, \text{ etc.} \quad (7.1.54b)$$

The “hidden” character of gravitation in conventional gauge theories is then confirmed by the isoexpectation value of the isounit recovering the conventional unit I of gauge theories,

$$\hat{\langle I \rangle} = \langle \hat{\psi} | \times \hat{T} \times \hat{I} \times \hat{T} \times | \hat{\psi} \rangle / \langle \hat{\psi} | \times \hat{T} \times | \hat{\psi} \rangle = I. \quad (7.1.55)$$

It then follows that *IGU constitutes an explicit and concrete realization of the theory of “hidden variables”* [40]

$$\lambda = T(x) = g(x)/\eta, \hat{H} \hat{\times} | \hat{\psi} \rangle = \hat{H} \times \lambda \times | \hat{\psi} \rangle = E_\lambda \times | \hat{\psi} \rangle, \quad (7.1.56)$$

and the theory is correctly reconstructed with respect to the new unit

$$\hat{I} = \lambda^{-1}, \quad (7.1.57)$$

in which von Neumann’s Theorem [41] and Bell’s inequalities [42] do not apply, evidently because of the nonunitary character of the theory (see Ref. [21] and Vol. II of Refs. [15] for details).

In summary, the proposed inclusion of gravitation in unified gauge theories is essentially along the teaching of Einstein, Podolsky, and Rosen [43] on the “lack of completion” of quantum mechanics, only applied to gauge theories.

7.2 ISO-, GENO-, AND HYPER-SELF-DUAL COSMOLOGIES

A rather popular belief of the 20-th century was that the universe is solely composed of matter. This belief was primarily due to the scientific imbalance pertaining to antimatter as being solely studied at the level of second quantization, without any theoretical, let alone experimental, mean available for the study of antimatter.

In reality, there exists rather strong evidence that the universe is indeed composed of matter as well as antimatter and, more particularly, that some of the galaxies are made up of matter and others of antimatter.

To begin, not only the expansion of the universe, but more particularly the recently detected increase of the expansion itself, can be readily explained via an equal distribution of matter and antimatter galaxies.

In fact, antigravity experienced by matter and antimatter galaxies (studied in the preceding chapter) explains the expansion of the universe, while the continuous presence of antigravity explains the increase of the expansion.

The assumption that the universe originated from a primordial explosion, the “big bang”, could have explained at least conceptually the expansion of the universe. However, the “big bang” conjecture is eliminated as scientifically possible by the increase of the expansion itself.

The “big bang” conjecture is also eliminated by the inability to explain a possible large presence of antimatter in the universe, trivially, because it would

have been annihilated at the time of the “big bang” because produced jointly with matter, as well as for other reasons.

By comparison, the only plausible interpretation at the current state of our knowledge is precisely the assumption that the universe is made up half of *matter galaxies* and half of *antimatter galaxies* due to the joint explanation of the expansion of the universe and its increase.

Independently from the above, there exists significant evidence that our Earth is indeed bombarded by antimatter particles and asteroids.

Astronauts orbiting Earth in spaceship have systematically reported that, when passing over the dark side, they see numerous flashes in the upper atmosphere that can be only interpreted as *antimatter cosmic rays*, primarily given by high energy antiprotons and/or positrons⁷ originating from far away antimatter galaxies, which antiparticles, when in contact with the upper layers of our atmosphere, annihilate themselves producing the flashes seen by astronauts.

Note that the conventional *cosmic rays* detected in our atmosphere are *matter cosmic rays*, that is, high energy *particles*, such as protons and electrons, originating from a matter supernova or other matter astrophysical event.

In any case, it is evident that matter cosmic rays with sufficient energy can indeed penetrate deep into our atmosphere, while antimatter cosmic rays will be stopped by the upper layers of our atmosphere irrespective of their energy.

In addition, there exists evidence that our Earth has been hit by *antimatter meteorites* that, as such, can only originate from an astrophysical body made up of antimatter.

The best case is the very large devastation recorded in 1908 in Tunguska, Siberia, in which over one million acres of forest were completely flattened in a radial direction originating from a common center without any crater whatever, not even at the center.

The lack of a crater combined with the dimension of the devastation, exclude the origination from the explosion of a *matter asteroid*, firstly, because in this case debris would have been detected by the various expeditions in the area and, secondly, because there is no credible possibility that the mere explosion of a matter asteroid could have caused a devastation over such a large area requiring energies computed at about 100 times the atomic bomb exploded over Hiroshima, Japan.

The only plausible interpretation of the *Tunguska explosion* is that it was due to an antimatter asteroid that eventually annihilated after contact deep into our matter atmosphere.

The important point is that the numerical understanding of the Tunguska explosion requires an antimatter mass of the order of a ton, namely, an antimatter

⁷Evidently only *stable antiparticles can travel intergalactic distances without decaying.*

asteroid that, as such, can only originate from the supernova explosion of an antimatter star.

Consequently, the evidence on the existence of even one antimatter asteroid confirms the existence in the universe of antimatter stars. Since it is highly improbable that antimatter stars can exist within a matter galaxy, antimatter asteroids constitute significant evidence on the existence in the universe of antimatter galaxies.

But again, the expansion of the universe as well as the increase of the expansion itself are the strongest evidence for an essentially equal distribution of matter and antimatter galaxies in the universe, as well as for the existence of antigravity between matter and antimatter.

In any case, there exist no alternative hypothesis at all known to this author, let alone a credible hypothesis, that could explain quantitatively both the expansion of the universe and the increase of the expansion itself.

In view of the above occurrences, as well as to avoid discontinuities at creation, Santilli [44] proposed the new *Iso-Self-Dual Cosmology*, namely, a cosmology in which the universe has an exactly equal amount of matter and antimatter, much along the isoselfdual re-interpretation of Dirac's equation of Section 2.3.6.

Needless to say, such a conception of the universe dates back to the very birth of cosmology, although it was abandoned due to various reasons, including the lack of a consistent classical theory of antimatter, inconsistencies for negative energies, and other problems.

The above conception of the universe was then replaced with the "big bang" conjecture implying a huge discontinuity at creation, in which a possible antimatter component in the universe is essentially left untreated.

All the above problems are resolved by the isodual theory of antimatter, and quantitative astrophysical studies on antimatter galaxies and quasars can now be initiated at the purely classical level.

Moreover, the prediction that the *isodual light* emitted by antimatter experiences a repulsion in the gravitational field of matter [38], permits the initiation of actual measurements on the novel *antimatter astrophysics*.

Noticeably, there already exist reports that certain astrophysical events can only be explained via the repulsion experiences by light emitted by certain galaxies or quasars, although such reports could not be subjected to due scientific process since the mere existence of such a repulsion would invalidate Einstein's gravitation, as studied in Section 1.4.

Even though the assumption of an equal distribution of matter and antimatter in the universe dates back to the discovery of antimatter itself in the early 1930s, the *Iso-Self-Dual Cosmology* is structurally new because it is the first cosmology in scientific records based on a *symmetry*, let alone an *isoselfdual symmetry*, that

of Dirac's equation subjected to isotopies, Eqs. (7.1.43), i.e.,

$$\begin{aligned}\hat{S}_{Tot} &= (\hat{\mathcal{P}}(3.1) \hat{\times} \hat{G}) \times (\hat{\mathcal{P}}(3.1)^d \hat{\times}^d \hat{G}^d) = \\ &= [\hat{S}L(2, \hat{C}) \hat{\times} \hat{T}(3.1) \hat{\times} \hat{\mathcal{I}}(1)] \times [\hat{S}L^d(2, \hat{C}^d) \hat{\times}^d \hat{T}^d(3.1) \hat{\times}^d \hat{\mathcal{I}}^d(1)].\end{aligned}\quad (7.2.1)$$

In fact, virtually all pre-existing cosmologies are based on Einstein's gravitation, thus eliminating a universal symmetry *ab initio*.

Other novelties of the Iso-Self-Dual Cosmology are given by the implications, that are impossible without the isotopies and isodualities, such as:

1) The direct interpretation of the expansion of the universe, as well as the increase of the expansion itself, since antigravity is permitted by the isodualities but not in general by other theories;

2) The prediction that the universe has absolutely null total characteristics, that is, an absolutely null total time, null total mass, null total energy, null total entropy, etc., as inherent in all isoselfdual states⁸;

3) The creation of the universe without any discontinuity at all, but via the joint creation of equal amounts of matter and antimatter, since all total characteristics of the universe would remain the same before and after creation.

We also mention that the isoselfdual cosmology was proposed by Santilli [44] to initiate mathematical and theoretical studies on the creation of the universe, studies that are evidently prohibited by theories with huge discontinuities at creation.

After all, we should not forget that the Bible states the creation first of light and then of the universe, while it is now known that photons can create a pair of a particle and its antiparticle.

Also, there is a mounting evidence that space (the *aether* or the *universal substratum*) is composed of a superposition of positive and negative energies, thus having all pre-requisites needed for the creation of matter and antimatter galaxies.

As one can see, a very simple property of the new number theory, the invariance under isoduality as it is the case for the imaginary unit (Section 2.1.1),

$$i \equiv i^d = -i^\dagger = -\bar{i}, \quad (7.2.2)$$

acquires a fundamental physical character for a deeper understanding of Dirac's gamma matrices (Chapter 2),

$$\gamma_\mu \equiv \gamma_\mu^d = -\gamma_\mu^\dagger, \quad (7.2.3)$$

⁸We are here referring to intrinsic characteristic of isoselfdual states, and not to the same characteristics when inspected from a matter or an antimatter observer that would be evidently impossible for the universe.

and then another fundamental character for the entire universe.

To understand the power of isodualities despite their simplicity, one should meditate a moment on the fact that the assumed main characteristics of the universe as having an equal amount of matter and antimatter, can be reduced to a primitive abstract axiom as simple as that of the new invariance (7.2.2).

Needless to say, the condition of exactly equal amounts of matter and antimatter in the universe is a *limit case*, since in reality there may exist deviations, with consequential *breaking of the isoselfdual symmetry* (7.2.1). This aspect cannot be meaningfully discussed at this time due to the abyssal lack of knowledge we now have on the antimatter component in our universe.

It should be finally indicated that, in view of the topological features assumed for the basic isounit

$$\hat{I} = \hat{I}^\dagger > 0, \quad (7.2.4)$$

the Iso-Self-Dual Cosmology outlined above can only represent a closed and reversible universe, thus requiring suitable broadening for more realistic theories.

Recall that, from its Greek meaning, “cosmology” denotes the entire universe. Consequently, no theory formulated until now, including the Iso-Self-Dual Theory, can be called, strictly speaking, a “cosmology” since the universe is far from being entirely composed of closed and reversible constituents.

To begin, there is first the need to represent irreversibility, since the behavior in time of all stars, galaxies and quasars in the universe is indeed irreversible.

This first need can be fulfilled with the Iso-Self-Dual Cosmology realized via isounits that are positive-definite, but explicitly time dependent,

$$\hat{I}(t, \dots) = \hat{I}^\dagger(t, \dots) \neq \hat{I}(-t, \dots), \quad (7.2.5)$$

which feature assures irreversibility, although the universe remains closed due to the conservation of the total energy of matter and that of antimatter.

The latter model has evident limitations, e.g., in view of the possible continuous creation of matter and antimatter advocated by various researchers as an alternative to the “big bang”.

The latter condition, when joint with the necessary representation of irreversibility, requires the broader *Geno-Self-Dual Cosmology*, namely, a cosmology based on the Lie-admissible lifting of symmetry (7.2.1), via the further generalization of generalized units (7.3.4) and (7.2.5) into four genounits, one per each of the four possible directions of time

$$\hat{I}^>, \quad -\hat{I}^>, \quad (\hat{I}^>)^d = -<\hat{I}, \quad -(\hat{I}^>)^d = <\hat{I}, \quad (7.2.6)$$

whose explicit construction is left to the interested reader for brevity (see Chapter 5).

Nevertheless, the latter genotopic lifting itself cannot be considered, strictly speaking, a “cosmology” because a basic component of the universe is life, for which genotopic theories are insufficient, as indicated in Section 3.7, due to their single-valuedness.

The latter need inevitably requires the formulation of cosmologies via the most general possible methods studied in this monograph, the multivalued hyperstructure of Chapter 5, resulting in the *Hyper-Self-Dual Cosmology*, namely, a cosmology based on the hyperlifting of symmetry (7.2.1) characterized by the ordered multivalued hyperunits

$$\hat{I}^> = \{\hat{I}_1^>, \hat{I}_2^>, \hat{I}_3^>, \dots\}, \quad -\hat{I}^> = \{-\hat{I}_1^>, -\hat{I}_2^>, -\hat{I}_3^>, \dots\}, \quad (7.2.7a)$$

$$(\hat{I}^>)^d = \{-^<\hat{I}_1, -^<\hat{I}_2, -^<\hat{I}_3, \dots\}, \quad -(\hat{I}^>)^d = \{^<\hat{I}_1, ^<\hat{I}_2, ^<\hat{I}_3, \dots\}. \quad (7.2.7b)$$

However, at this point we should remember the limitations of our mind and admit that the foundations of the Hyper-Self-Dual Cosmology, such as the multivalued hypertime encompassing all four directions of time, is simply beyond our human comprehension.

After all, we have to admit that a final scientific understanding of life will likely require thousands of years of studies.

7.3 CONCLUDING REMARKS

The analysis conducted in this monograph establishes that the isodual theory of antimatter does indeed resolve the scientific imbalance of the 20-th century caused by the treatment of matter at all levels of study, and the treatment of antimatter at the sole level of second quantization.

In fact, the isodual theory of antimatter achieves an absolute democracy of treatment of both matter and antimatter at all levels, from Newton to second quantization.

In particular, the analysis presented in this monograph establishes that the isodual theory of antimatter is verified by all known experimental data on antimatter, since the isodual theory trivially represents all available classical experimental data (Section 2.2.3), while resulting in being equivalent to charge conjugation at the operator level (Section 2.3.7), as a result of which the entire currently available experimental knowledge on antiparticles is verified by the isodual theory.

Despite its simplicity, the isodual theory of antimatter has deep implications for all quantitative sciences, including classical mechanics, particle physics, superconductivity, chemistry, biology, astrophysics and cosmology.

The most salient consequence of the isodual theory is the prediction of antigravity experienced by *elementary* antiparticles in the field of matter and vice-versa.

This prediction is a direct consequence of the very existence of a consistent classical formulation of antimatter, the electromagnetic origin of the gravitational

mass with consequential phenomenological equivalence of electromagnetism and gravitation for both attraction and repulsion, the forgotten Freud identity of the Riemannian geometry, and other aspects.

In reality, the prediction of antigravity for truly elementary antiparticles in the field of matter is rooted in so many diversified aspects that the possible experimental disproof of antigravity would likely require the reconstruction of theoretical physics from its foundations.

To minimize controversies, it should be stressed that the prediction of antigravity has been solely and specifically presented for *elementary* antiparticles, that is, for the *positron*, with the careful exclusion for first tests of any unstable or composite particles whose constituents are not seriously established as being all antiparticles.

As an illustration, we have discouraged the use in possible experiments on the gravity of the positronium as claim for final knowledge on the gravity of antimatter, because the positronium is predicted by the isodual theory to be attracted in both fields of matter and antimatter. Similarly we have discouraged the use of leptons because they may eventually result to be composite of particles and antiparticles.

Finally, we have strongly discouraged to assume experimental data on the gravity of antiprotons as final knowledge on the gravity of antiparticles, because antiprotons are today fabricated in high energy laboratories from matter components and are believed to be bound states of quarks for which no gravity at all can be consistently defined [38].

It then follows that, while all experimental data are indeed useful and should be supported, including experimental data on the gravity of antiprotons, their use for general claims on the gravity of antimatter could be deceptive.

Moreover, none of the numerous arguments against antigravity could even be properly formulated for the isodual theory, let alone have any value. As a result, the prediction of antigravity for elementary antiparticles in the field of matter is fundamentally unchallenged at this writing on theoretical grounds.

A test of the gravity of positrons in horizontal flight in a vacuum tube, that is resolatory via gravitational deflections visible to the naked eye, has been proposed by Santilli [45] and proved by the experimentalist Mills [46] to be feasible with current technology and be indeed resolatory (Section 4.2).

A comparative study of other tests has revealed that they are too delicate and require too sensitive measurements to be as resolatory as proposal [45] with current technologies.

It is hoped that the experimental community finally comes to its senses, and conducts fundamental test [45,46], rather than continuing to conduct tests of transparently less relevance at bigger public costs, because in the absence of a

final experimental resolution of the problem of antigravity, the entire theoretical physics remains essentially in a state of suspended animation.

In turn, the possible experimental verification of antigravity (as above identified) would have implications so advanced as to be at the edge of our imagination.

One of these implications has been presented in Section 13.3 with the Causal Time Machine, the novel, non-Newtonian *isolocomotion* (propulsion to unlimited speeds without any action and reaction as requested by all currently available propulsions), and other far reaching possibilities.

The experimental resolution of the existence of antigravity for *truly elementary* antiparticles is also crucial to fulfil the original scope for which the isodual theory was built, namely, to conduct quantitative studies as to whether far-away galaxies and quasars are made up of matter or antimatter.

This main scope has been achieved via the *isodual photon*, namely, the discovery that, according to the isodual theory, photons emitted by antimatter appear to have a number of physical differences with the photons emitted by matter. In particular, *the simplest possible isodual electromagnetic waves have negative energy, thus experiencing antigravity in the field of matter.*

The above prediction requires the experimental resolution as to whether light emitted by antimatter is attracted or repelled by the gravitational field of matter.

Needless to say, the current availability at CERN of the antihydrogen atom is an ideal source for such a study, with the understanding that gravitational deflections of light at short distances (as attainable in a laboratory on Earth) are extremely small, thus implying extremely sensitive measurements.

More promising is the re-inspection of available astrophysical data privately suggested to the author because said data could already include evidence of light from far-away galaxies and quasars that is repelled by astrophysical objects closer to us.

Such a repulsion could not be publicly disclosed at this time because of known opposition by organized academic interests on Einsteinian doctrines since, as well known, Einstein's gravitation prohibits the existence of antigravity (Section 4.1).

It is hoped that such organized academic interests come to their senses too, if nothing else, to avoid an easily predictable serious condemnation by posterity, in view of the well known catastrophic inconsistencies of Einstein gravitation outlined in Section 1.4.

After all, we should not forget that antiparticles were first experimentally detected in cosmic rays, thus confirming their possible origin from supernova explosions of stars made up of antimatter.

Also, there are reports of huge explosions in Earth's atmosphere before the advent of atomic bombs without any crater on the ground, such as the 1908 Tunguska explosion in Siberia, which explosions can be best interpreted as anti-

matter asteroids from far away antimatter galaxies or quasars penetrating in our atmosphere.

Therefore, it should not be surprising if light experiencing gravitational repulsion from matter is discovered first in astrophysics.

Additional tests on the possible gravitational repulsion of light emitted by antimatter can be done via the direct measurement of the deflection of light from far away galaxies and quasars when passing near one of the planets of our Solar system.

Under the assumption of using light originating from far away galaxies and quasars (to render plausible their possible antimatter nature), and for the use of a sufficient number of galaxies and quasars (to have a sufficient probability that at least one of them is made up of antimatter), these astrophysical measurements are potentially historical, and will signal the birth of the new science proposed in this monograph under the name of *antimatter astrophysics*.

The reader should be aware that, while the prediction of antigravity for *truly elementary* antiparticles is an absolute necessity for the validity of the isodual theory, the gravitational behavior of light emitted by antimatter is not that simple.

Recall from Section 13.2 that the prediction of antigravity for light emitted by antimatter is based on the negative value of its energy for the selected solution of the electromagnetic wave.

However, the photons is invariant under charge conjugation and travel at the maximal causal speed in vacuum, c . Therefore, the photon could well result to be a superposition of positive and negative energies, perhaps as a condition to travel at the speed c , in which case the photon would be an isoselfdual state, thus experiencing attraction in both fields of matter and antimatter.

As a consequence, the possible disproof of antigravity for light emitted by antimatter stars in the field of matter *would not* invalidate the isodual theory of antimatter, but merely tell us that our conception of light remains excessively simplistic to this day, since it could well be in reality a composite state of photons and their isoduals.

The issue is further complicated by the fact indicated during the analysis of this monograph that *antigravity is predicted between masses with opposite time evolutions*, as it is the case for a positron in the field of Earth. However, the photon travels at the speed of light at which speed time has no meaningful evolution.

As a result, it is not entirely clear to this author whether the sole value of negative energy for the isodual light is sufficient for the existence of a gravitational repulsion, and the issue is suggested for study by interested colleagues.

To express a personal view, it would be distressing if light solely experience gravitational attraction irrespective of whether in the field of matter or antimatter and whether originating from matter or antimatter, because this would

imply the impossibility for experimental studies as to whether far-away galaxies and quasars are made up of matter or antimatter, since all other aspects, including thermodynamics, are not detectable at large distances, thus implying the perennial inability for mankind to reach any in depth knowledge of the universe.

The author does not believe so. Advances in human knowledge have no limit, and often go beyond the most vivid imagination, as established by scientific realities that resulted in being beyond the science fiction of preceding generations.

In closing, the author hopes that the studies presented in this monograph have stimulated young minds of any age and confirmed that science will never admit final theories. No matter how precious, beloved and valid a given theory may appear to be at a given time, its surpassing with broader theories more adequate for new scientific knowledge is only a matter of time.

References

- [1] B. Riemann, Gött. Nachr. **13**, 133 (1868) and *Collected Works* H.Weber, ed. (Dover, New York, 1953).
- [2] D. Hilbert, Nachr. Kgl. Ges. Wissench. Gottingen, 1915, p. 395.
- [3] A. Einstein, Sitz. Ber. Preuss. Akad. Wissssench Berlin, 1915, p. 844.
- [4] C. N. Yang and R. Mills, Phys. Rev. **96**, 191 (1954).
- [5] S. L. Glashow, Nuc. Phys. **22**, 579 (1961).
- [6] S. Weinberg, Phys. Rev.Lett. **19**,1264 (1967).
- [7] A. Salam, in *Elementary Particle Physics (Nobel Symp. No. 8)*, N. Svartholm, Almquist and Wiksell, ed. (Stockholm, 1968).
- [8] C. J. Isham, R. Penrose and D. W. Sciama, Editors, *Quantum Gravity 2* (Oxford University Press, Oxford, 1981).
- [9] R. M. Santilli, Found. Phys. Letters **10**, 305 (1997).
- [10] R. M. Santilli, contributed paper in the *Proceedings of the Eight Marcel Grossmann Meeting in Gravitation*, T. Piran, and R. Ruffini, Editors, World Scientific, pages 473-475 (1999).
- [11] R. M. Santilli, Annales Fondation L. de Broglie, **29**, 1 (2004).
- [12] R.M.Santilli, Hadronic J. **1**, 224, 574 and 1267 (1978).
- [13] R. M. Santilli, Phys. Rev. D **20**, 555 (1979).
- [14] R. M. Santilli, Rendiconti Circolo Matematico Palermo, Suppl. **42**, 7 (1996).
- [15] R. M. Santilli, *Elements of Hadronic Mechanics*, Vol. I; *Matheatical Foundations*, 2-nd Edition 1995, Vol. II: *Theoretical Foundations*, 2-nd Edition 1995, Ukrainian Academy of Sciences, Kiev.
- [16] R. M. Santilli, Hadronic J. **8**, 25 and 36 (1985).
- [17] R. M. Santilli, Hadronic J. **17**, 257 (1994).
- [18] R.M.Santilli, Nuovo Cimento Lett. **37**, 545 (1983).
- [19] R. M. Santilli, Nuovo Cimento Lett. **38**, 509, (1983).
- [20] R. M. Santilli, JINR Rapid Comm. **6**, 24 (1993).
- [21] R. M. Santilli, Acta Appl. Math. **50**, 177 (1998).
- [22] R. M. Santilli, J. Moscow Phys. Soc. **3**, 255 (1993).
- [23] R. M. Santilli, JINR Comm. No. E4-93-352 (1993).
- [24] R. M. Santilli, Chinese J. Syst. Eng. and Electr. & Electr. **6**, 177 (1996).

- [25] R. M. Santilli, *Algebras, Groups and Geometries* **10**, 273 (1993).
- [26] R. M. Santilli, in *Proceedings of the Seventh M. Grossmann Meeting on General Relativity*, R. T. Jantzen, G. Mac Kaiser and R. Ruffinni, Editors, World Scientific, Singapore (1996), p. 500.
- [27] R. M. Santilli, *Found. Phys.* **27**, 691 (1997).
- [28] R. M. Santilli, *Intern. J. Modern Phys. D* **7**, 351 (1998).
- [29] M. Gasperini, *Hadronic J.* **6**, 935 and 1462 (1983).
- [30] M. Nishioka, *Hadronic J.* **6**, 1480 (1983) and *Lett. Nuovo Cimento* **40**, 309 (1984).
- [31] G. Karayannis and A. Jannussis, *Hadronic J.* **9**, 203 (1986).
- [32] R. M. Santilli, *Intern. J. Modern Phys. A* **14**, 3157 (1999).
- [33] J. V. Kadeisvili, *Algebras, Groups and Geometries* **9**, 283 and 319 (1992).
- [34] G. T. Tsagas and D. S. Sourlas, *Algebras, Groups and geometries* **12**, 1 (1995).
- [35] R. M. Falcón Ganfornina and J. Núñez Valdés, *Balkan Journal of Geometry and Its Applications*. In press (2004).
- [36] R. M. Falcón Ganfornina and J. Núñez Valdés, *Algebras, Groups and Geometries* **20**, 1 (2003).
- [37] R. Aslaner and S. Keles, *Algebras, Groups and Geometries* **14**, 211 (1997).
- [38] R. M. Santilli, *Hyperfine Interactions*, **109**, 63 (1997).
- [39] S. Adler, A. Bazin and L. Schieffer, *Introduction to General Relativity* (Mc. Graw-Hill, New York, 1984).
- [40] D. Bohm, *Quantum Theory*, Dover Publications, New York (1979).
- [41] J. Von Neumann, *The Mathematical Foundations of Quantum Mechanics*, Princeton University Press, Princeton (1955).
- [42] J. S. Bell, *Physica* **1**, 195 (1965).
- [43] A. Einstein, B. Podolsky, and N. Rosen, *Phys. Rev.* **47**, 777 (1935).
- [44] R. M. Santilli, contributed paper to proceedings of the *International Workshop on Modern Modified Theories of Gravitation and Cosmology*, E. I. Guendelman, Editor, Hadronic Press, pages 113-169 (1998).
- [45] R. M. Santilli, *Hadronic J.* **17**, 257 (1994).
- [46] J. P. Mills, jr, *Hadronic J.* **19**, 1 (1996).

Postscript

In the present second volume of his opus magnum, *Hadronic Mathematics, Mechanics and Chemistry*, Professor Ruggero Maria Santilli applies the extensive advances to pure mathematics, presented in the first volume, to a plethora of basic and far-reaching issues in the natural sciences of physics and chemistry. By these means he attains theoretical results not possible to achieve without use of these new and powerful mathematical tools or the extensions of our ontological horizon of the universe associated with the establishment of the new number fields discovered by hadronic mathematics. This second volume also presents available established experimental evidence offering crucial support to predictions from the new sciences of hadronic mechanics and chemistry, sketches of experimental design for further support and theoretical refinements (or falsifications), and emergence of new and quite spectacular technology made possible from these advances in theoretical science. Some of this technology has already been constructed and is up-and-running, and constitutes matured fruits of the quite gigantic scientific enterprise initiated by Santilli four decades ago, and with growing affiliation from co-scientists world-wide throughout the years.

In the exploring spirit of the Renaissance, one might say that the first volume offers a guiding compass and the basic skills for constructing adequate maps and ships to search for unknown continents, while this second volume presents maps as well as treasures after having successfully travelled, reached and traced unknown continents on the other side of the vast ocean of the unknown.

Scientific revolutions in the sense of Thomas Kuhn do not happen often in the history of science, and with regard to physics the last ones, quantum mechanics and Einsteins relativity theory, have now reached the age of 100 year old-timers. With the rapidly increasing number of scientists and over-all significance of scientific progress for modern society, it is not too strange from a birds-eye-view of the history of science that a new revolution has found its day.

The new theory of physics as a whole, coined hadronic mechanics by Santilli, does not question the validity of the theories of quantum mechanics and relativity theory for the physical world, given the constraints formulated by the great creators of the said theories, represented by the kind of physical objects and relations being studied by the theory, and the proper simplifications in the describing and explaining models of such objects, dependent on the nature of the objects and the available mathematics. Basically, the constraints of these theories consist in their relevance being restricted to the so-called exterior physical world, which is

the physical world outside the hadronic horizon of one femtometer. For interior relations, inside the hadronic horizon, the models and equations of these theories did not claim any immediate validity by their originators and, therefore, they are not scientifically legitimate to import inside the hadronic horizon, at least not without careful theoretical considerations on the basic problems therein involved, and without support from crucial experiments. Sad to say, this book offers much argument and evidence for a lot of such illegitimate import to have been the normal state of affairs during the second half of 20th century standard physics.

Assuming the strong interaction being adequately represented as the interaction between three point-like baryon quarks in the hadron, quantum mechanics did not succeed in establishing any good and experimentally testable model of the strong interaction, partly due to the complexities involved with the required non-linear mathematics to describe such a system. Largely because of these problems, the unification of the three other well-known forces with the strong force remained an open problem during 20th century standard physics. Equipped with the developed isomathematics, Santilli disposed the necessary tools to leave the assumption of interior point-quarks, and to describe shapes, as well as changes in shapes coined deformations, of particles with physical extension, to approach the problem of strong interactions inside the hadronic horizon. By means of isomathematics, Santilli was able to quantitatively model the neutron as a bound state of a proton and an electron, and hence to reestablish Rutherford's notion of the neutron as a compressed hydrogen atom. This achievement by Santilli was enthusiastically commented on by the great philosopher of science, Karl Popper, in his book from 1982, as a return to sanity, to that realism and objectivism for which Einstein stood.

The Rutherford-Santilli model of the neutron described the proton and the electron as a bound state with overlapping wave packets. Such a compression could only be imagined as a result of an external trigger, for example the role of pressure in the case of neutron synthesis in stars. For the neutron to stay in a bound state, the bound state had to be imagined as a singlet of a proton and an electron with opposite spins, according to the so-called gear model ruling out the possibilities of triplets or parallel spins. By 1990 Santilli had been able to publish such a model of the neutron as a mutated bound state with an exact quantitative representation of its physical characteristics: rest energy, mean life, charge radius, charge, charge parities, space, spin, and (anomalous) magnetic and electric moment.

Such a model would not have been possible by importing the quantum mechanics for exterior relations to the inside of the hadronic horizon, due to the idea of quantum quantization being contrary to the deep interpenetration of the wave packets inside the hadronic horizon and to the non-existence of excited hadronic states. Such excitation would imply tunneling through the hadronic horizon,

which by Santilli was stated as the very mechanism of the neutrons spontaneous decay. In this way Santillis model of neutron synthesis, as well as neutron decay, did not need any assumption about existence of sub- or quasi-particles as in the notion of quarks, nor was there any need to imagine said processes to rely on a somewhat mystical notion of the two stable elementary particles of the physical world, protons and electrons, being created from and resolved into intermediary states of quark assemblies. In this regard Santillis theory of the neutron offered a much simpler picture of the situation inside the hadronic horizon as well as of the relation to the exterior physical world. Elegant and adequate simplifications are what good science should be about; the question was if the theory was to become supported by experimental evidence. Such significant support was provided when the measured density of the so-called fireball in the Einstein Bose correlation of colliding proton and antiproton was shown to be very close to the hadronic calculation of the density of the neutron, as predicted by hadronic mechanics. Crucial additional support was added from the experiments headed by Prof. Tsagas in 1996 with 319 stimulated decays of the neutron, expelling the Rutherford electron when exposed to the resonance frequency of a hard photon, in accordance with the predictions from hadronic mechanics. (Sad to say, no other laboratories in the world have so far wanted to retest these results by duplicating such experiments, in spite of the great scientific, technological and ecological significance of such confirmation.)

In analogy with the neutron model, Santilli already in 1978, the birth year of hadronic mechanics, had been able to present a model of the 0 meson as a bound state of an electron and a positron with overlapping wave packets, i.e. as a compressed positronium. Also this model was able, differently from quantum mechanics, to represent all physical characteristics of the 0 meson without any additional notion of quarks, and this in one single structural equation. However, it is important to notice that the said bound state is not a bound state of the involved particles as considered outside the hadronic horizon, since physical attributes of the particles undergo some changes in this compression. Such states are, therefore, only possible to describe by means of isomathematics and from the accordingly broader concept of isoparticles.

In general, different from quantum mechanics, hadronic mechanics represents a theory of physics equipped with concepts, models and mathematics to describe and explain relations interior to the hadronic horizon. However, to be able to succeed in this, hadronic mechanics had to be developed as a lifted theory compared to quantum mechanics, thereby providing a more general theory of physics, just as valid for exterior relations as quantum mechanics, the last being a sub-field of hadronic mechanics. Therefore, it is not adequate to consider hadronic mechanics as a supplement or a competitor to quantum mechanics, but as a theory of physics with a broader explanatory power than quantum mechanics, also being

able to adequately include interior relations, as well as relations between the interior and the exterior. This broadening-from-lifting follows the general scheme of development of basic theoretical advances in physics as analyzed in David Bohm's interpretation of the modern history of physics.

The theory of hadronic superconductivity, initiated by Prof. Animalu and Santilli from 1994, constitutes an important bridge between hadronic mechanics and hadronic chemistry. In superconductivity theory, as approached by quantum mechanics, it was quite a mystery how the bound state of the Cooper pair could emerge and remain, considering that two electrons are known to be repelled by the Coulomb force. However, from hadronic mechanics this became explainable with the notion of a hitherto unknown physical force becoming activated when two particles are brought into touch from an external trigger, this fifth force inducing total overlap between the two involved wave packets. Different from the four conventional forces, this was a contact force without a potential, and thus requiring a non-Hamiltonian for its mathematical description; - hence being outside the reach of quantum mechanics. Also, the force was described by hadronic mechanics not to depend on the sign of the charge of the involved particles. Thus, the Cooper pair could be explained with this force simply being stronger than the Coulomb force. Due to deep interpenetration of the wave packets, the Cooper pair, by analogy with the cases of the neutron and the compressed positronium, had to be modeled, not as conventional electrons in the exterior, but as isoelectrons.

Further, the Cooper pair in hadronic superconductivity was modeled with an 8-shaped orbit around the two nuclei involved in the superconductivity structure. This orbit shape induces an extraordinarily strong magnetic force from each nuclei, in the hydrogen atom calculated to be 1,415 times the strength of the ordinary magnetic force from the proton, and of course in opposite directions from the two nuclei. Similar superconductivity structures could then be attracted and bound together, aligning from the orientations of the extraordinarily strong magnetic forces from the nuclei, and clustering into bigger structures of atoms (as well as with the possibility to include dimers, radicals or molecules). These clusters were coined *magnecules* by Santilli, and were predicted from hadronic superconductivity to be discovered by experiments. This became confirmed by independent laboratories, using adequate special apparatus for such detections, from 1998 on. Santilli also invented and patented so-called plasma-arc-flow reactors, also called hadronic reactors and sometimes *ecoreactors*, to produce *magnecules* in specified types and quantities in a controlled manner. Already at Dec. 15, 1998, Santilli presented the first constructed reactor producing such new chemical species. 1998 became the take-off year of hadronic chemistry also as a scientific discipline, with a special issue of the *Hadronic Journal* solely dedicated to presenting the scientific foundations of this lifted and broader chemistry.

Besides Santilli the publication included among its authors Profs. Shillady and Aringazin.

The discovery of magnecules represented the first discovery of a new chemical species since the discovery of molecules in the mid-1800s. Different from molecules, magnecules have non-valence bonds and they can form much larger structures, in superfluids sometimes even visible by the naked eye. Most scientists researching superconductivity with only quantum mechanics at their disposal, believe that superconductivity is restricted to extremely low temperatures (somewhat misleading referring to temperatures far below zero as High Tc superconductivity), while hadronic chemistry has explained hadronic superconductivity to be possible also for fluids and gases, activated by the external trigger of strong and close enough magnetic fields. It is a matter of fact that hadronic reactors have been producing such magnecular gases since 1998. This is a quite bizarre situation, and also with a somewhat macabre touch, since use of magnecular gas has been proven to have highly favorable ecological applications. Compared to molecules, magnecules have many different chemical attributes, explained in detail from hadronic chemistry and experimental evidence in the present volume. For example, when used as a fuel for vehicles, exhaust from combustion of magnecular hydrogen gas has a molecular composition very different from the exhaust of molecular hydrogen gas. The first does not contain potential carcinogens of the latter, has only half the CO₂ content, and adds, contrary to the latter, a significant amount (10-12

Compared to the molecular hydrogen gas, the density of the corresponding magnecular gas is about 7.5 times higher. This implies that, on the same tank volume and pressure, a car fuelled on magnecules drives 7.5 times the distance of a car fuelled on molecules. Such effective magnecular fuel is not possible to produce without hadronic reactors, which construction presupposed hadronic mechanics with related hadronic mathematics. In this way, the existing hadronic technology, and there are other examples as well, offers quite simple tests to convince any sound skeptic about the superiority of the hadronic sciences as a whole, compared to standard physics constituted inside century old paradigms.

Hadronic reactors also offer considerable advantages on the input side, because they apply either oil or water solutions as their inputs, and the degree of pollution of the inputs does not matter, insofar as they are not radioactive. In the reactor process, where the plasma reaches temperatures higher than the surface of the sun, the molecules are broken down to their constituents before being recombined as magnecules with non-valence bonds. Thereby almost all molecular pollutants disappear, including for example sewage water or pharmaceutical toxins. At the output side, there is produced, along with the magnecular gas, either chemical clean water or heat that can be applied for useful purposes. Furthermore, Santilli has also succeeded in developing magnecular technology specifically

designed as an additive to coal processing in order to reduce the globally heavy load of environmental pollution from this energy technology. Also to consider among Santillis amazing inventions, is the new hadronic technology of so-called intermediate nuclear fusion.

The foundations of scientific theory behind these technological progressions, which ought to be highly welcomed in the contemporary alarming ecological situation, are not only solid, but much more extensive and by far superior to the whole disciplines of standard quantum mechanics and chemistry, as fleshed out in much detail in the present volume. It is not without good reason that Santilli in his informative mammoth article in *Foundations of Physics* of Sept. 2003, a journal counting eight Nobel laureates in physics in its editorial board, emphasized the discovery of magnecules as the most precious fruit of his lifelong scientific endeavor.

The radical implications of scientific revolutions are hard to overview for contemporaries, sometimes including the pioneering scientists themselves. As a prominent mathematical physicist once said to the author of this postscript: Who would have guessed, back in the 1920s, that such a bizarre theory as quantum mechanics should gain such broad applications in upcoming technology? With regard to chemistry, it appears hard to find any historic parallel to the degree of progress represented or announced by hadronic chemistry, without moving back to the discovery of the periodic table. The panorama of magnecules reveals a previously hidden landscape of a whole new chemical world. It appears nave to suppose that these landscapes are restricted to artificial creations of substances by means of human high technology. In the last sentence of his 2001 book on hadronic chemistry, Santilli predicts the discovery of hyper-magnecules in biology. Also, his hadronic theory of lightning, offering more correct calculations of its accompanied sound quantities, describes this phenomenon as basically a hadronic reaction resulting in nitrogen synthesis. This may indicate that also other phenomena in nature, including biological and physiological nature, will prove to be better understood from hadronic chemistry, especially phenomena revealing superconductivity features. Of special significance may be the research and later applications of magnecular substances for medicine and health, a field so far not systematically targeted by advanced hadronic chemistry and technology, but already with some promising accumulation of more circumstantial evidence.

From the more overarching approach of the broader hadronic chemistry Santilli, partly in cooperation with other scientists, such as Shillady and Aringazin, from the late 1990s published new models also of the much studied molecules of hydrogen and water, earlier thought to be possible to be represented exactly by means of quantum chemistry, but argued by Santilli to be given exact representation of all chemical characteristics only by means of isochemical modeling not available for quantum chemistry. In 2007 Prof. Prez-Enrquez succeeded by

using hadronic chemistry to achieve a representation of the hydrogen molecule with amazingly exact matching with experimental data (among these representing the binding energy up to the 5th digit) by further developments from the Santilli-Shillady model and the Aringazin-Kucherenko approach, an achievement the preceding quantum chemistry was quite far from realizing. Also the work by Dr. Martin Cloonan has been able to reach new insights in fields of chemistry from his Cplex-isoelectronic theory by treating highly specialized knowledge in chemistry from the theoretical framework of hadronic chemistry. These recent developments may indicate an upcoming tendency to reframe specific problems of chemistry inside the broader umbrella of hadronic chemistry and thereby propel further progressions in the fields at hand, probably a challenge most suitable for the younger among talented chemists.

For many years Santilli has emphasized growing environmental concerns as a crucial motivation for his long-lasting scientific enterprise, and in the last decade also for his more recent occupation as an inventor. In spite of the many ecologically favorable applications of magnecular technology already appearing, Santilli regards the hadronic energy connected to the beta-electron released in the neutrons spontaneous decay as the most promising source for new and clean energy, likely to become harvested by upcoming hadronic technology based on hadronic mechanics. Calculations indicate that this energy is huge, without danger of radioactive radiation, and probably capable of capture by adequate trapping and shielding devices.

Considering this promising possibility judged from the theoretical advances in hadronic mechanics, and the possibly great implications for the ecosystem, it seems strange at first glance that powerful physics institutions and laboratories around the world so far have not wanted to execute crucial experiments to support or falsify predictions and earlier experiments from hadronic mechanics regarding neutron decay. The strangeness does not shrink when considering the modest amount of resources needed to execute such experiments, compared to the gigantic budgets of CERN and the like. Hadronic mechanics has already proved to be highly successful in achieving experimental verifications of new predictions from its theoretical extensions, as well as in constructing quite amazing new and eco-friendly technology outside the reach for quantum mechanics. A nave observer from outside the world of sophisticated theoretical physics may ask why it is that hadronic mechanics is being neglected, while a stream of resources is allocated to its sub-fields of quantum mechanics and relativity theory which has only been proven valid for the physical world outside the hadronic horizon. From reading semi-popular science magazines the outside observer will gain the impression that string theory is the most advanced physics around. But if so, how come that string theory, in spite of its rich inflow of mathematical talent and money resources, backed by mighty institutions, and much activity for some 25 years,

has not been successful in creating any new and favorable technology? Could it be that much of the reason is astonishingly simple, that these mathematical models have become too detached from the physical world, somewhat similar to the epicycles of the Middle Ages, constituting a self-sufficient and well fed giraffe-like research community not needing to care about rising revolutionary physics claiming basic theoretical advances backed by direct experimental support, or about the de facto emergence of new technology from this scientific revolution?

Scientific revolutions are not a tea party, and perhaps even less so in our time when the rise of significantly more advanced scientific theory not only threatens mighty characters in huge established science institutions, prestige hierarchies and networks nourished by a priori subscription to century old paradigms, but also related established interests in energy technology, finance and politics. Santilli has often stressed the evolutionary approach to this quest, by seeking serious dialogue and mutual exploration of the issues at hand with conventional scientists and institutions. In spite of this, Santilli has to a large extent been met with a Berlin wall of ignorance or non-scientific rejection, as indicated by the amazing near non-existence of published scientific questioning of the achievements in the hadronic sciences, today piling up to at least a library of 30.000 pages of published articles and monographs. Given the seriousness of the quest, not only for the further development of science, but for the very survival of our civilization by applying new technologies made possible from hadronic mechanics and chemistry, it seems likely that a more turbulent confrontation with different establishments antagonistic to radical extensions and liftings of conventional physics, is no longer possible to avoid. Considering the grave proportions of the rising ecological crisis, it may not be exaggerated to compare the situation with that of Semmelweiss, but with the difference that Santilli also talks from theoretical science above, not below the mighty scientists not able to leave their dogmas in spite of the implied damage done for the planet. Already in his three volume work of 1986, *Documentation of the Ethical Probe*, Santilli presented much food for thought concerning far from optimal scientific ethics being conducted in influential scientific communities. During the last two decades the picture has turned more severe, and the footnotes in the present volume provide much further material for competent evaluation of the present situation with regard to ethical vs. non-ethical conduct in the global science ecology. It may very well be that upcoming historians of science will look at the remarkably slow post-war development of main stream physics, when comparing the amount of basic advances to the resources spent and to the amount of advances the preceding part of the century, as connected to obstructions from profound non-scientific influences, paradoxically becoming fortified and nourished inside scientific institutions themselves.

Switching the focus to the brighter side, and lifting it to the visionary horizon inspiring great minds of science and art, it is important to note that hadronic

mechanics in its very architecture involves a whole new cosmology, opening vast new territories of the cosmos for human imagination, scientific exploration and technological endeavors.

Different from Einsteins relativity theory which doesnt treat antimatter, and different from quantum mechanics which allows the existence of antimatter only at second quantization, hadronic mechanics was able to treat matter and antimatter systematically on an equal footing, corresponding to the anti-symmetric structure in hadronic mathematics between the iso-, geno- and hyperfields vs. their respective isoduals. Hadronic mechanics comprehends our physical or Euclidean universe as a combination of two distinct universes, a matter universe and an antimatter universe. These two universes have a different anchoring in supra-spacetime, respectively in isospacetime and in isodual spacetime. However, isospacetime and isodual spacetime manifest in the same 3+1D space which they share and hence is to be comprehended as double-valued. Due to the antisymmetry of the two universes, positive mass in the matter universe will be projected as negative mass when experienced in the antimatter universe, and the same the other way around, and also the same with all other physical quantities, such as time, charge and energy. For the universe as a whole combination of the matter and the antimatter universe, all these magnitudes cancel out to zero. (This is also consistent with the key notion in the ambitious theory of universal rewrite nilpotent system recently worked out by mathematical physicist Peter Rowlands.)

This implies a comprehension of space itself as a universal substratum composed of a superposition of positive and negative energies, from which matter and antimatter galaxies are continuously created. This seems to provide an elegant solution for the mystery of from where the universe, considered as a closed system, receives its energy as a whole. If the universe has a paradoxical twin structure, the puzzle may be solved from a metabolism between the two moieties from the universal substratum, where the output energy from one moiety is received with the opposite sign as input energy for the other moiety, while the energy of the total universe remains zero or nilpotent. The philosophically quite simplistic Big Bang hypothesis, popular in much 20th century physics, is an answer to a question about the origin of the universe that does not make much sense when reframed from the more sophisticated cosmology and ontology of hadronic mechanics. Regarded from hadronic cosmology, treating antimatter with scientific democracy, as Santilli likes to put it, it is not quite the same universe anymore. According to hadronic cosmology, the universe is rather comprehended as inherently and continuously re-created, as it was by the great scientist David Bohm. On this background the Big Bang (and Crunch) hypothesis may be more adequately understood as a creation myth suitable for a conflated physicalistic and entropic world view painted in scientific cosmetics.

Hadronic cosmology constitutes a platform for much more optimistic and ambitious scientific undertakings. Santilli's theory of antimatter has formulated precise predictions of antigravity phenomena, and has designed experimental tests of antigravity for positrons and isodual light. Also, hadronic mechanics includes the notion of bound states of matter and antimatter, coined isoselfdual states, which opens up the possibility for time travel in the matter universe via intermediary switching onto the antimatter universe. Furthermore, Santilli describes causal spacetime machines which is the theoretical notion of way more radical space travel than the rocket technology developed half a century ago, and which applies the principle of isogeometric propulsion without Newtonian action-reaction. Hence, the realism in developing UFO technology for space travel much faster than the speed of light in vacuum, does not seem farfetched anymore from the theoretical advances of hadronic mechanics. These advances were only possible from the broadening of the theory of physics to include antimatter on an equal footing with matter, which in its turn presupposed the development of the new isonumber fields, with corresponding isogeometry, for quantitative treatments.

It is worth noticing that such space deformations are accompanied by changes in time as we ordinarily understand it. This implies a detrialization of the conventional time concept, where the familiar time arrow reduces to just one aspect of a more complex configuration of different types of time flows. In his pioneering studies of sea shell growth from hadronic geometry Chris Illert showed in the mid-1990s that a certain class of bifurcating sea shell followed a growth path that presupposed two non-trivial kinds of time flows, perceived as jumps forward and backward in conventional time. Such discovery of non-trivial time flows in a sufficiently profound specialist study of a complex irreversible system of nature, was exactly what was expected from the new time theory of hadronic mechanics which had added four types of non-trivial categories, so-called geno-times, to the conventional notion of time. Santilli has stated that for practical purposes there is no scientific difference between the new physical principles discovered in branching sea shells and those involved in the notion of causal spacetime machines.

Throughout the last century the quest of grand unification of gravitation with the three other conventional forces of physics remained a puzzling open problem in the struggles of standard physics. Santilli's theory of grand unification from hadronic mechanics presents gravitation as a macro phenomenon aggregated (with presented equations) from quantum electrodynamics de facto rooted in energy from the vacuum or universal medium. However, such a grand unification is argued by Santilli still not to be theoretically possible without acknowledging the democratic co-existence of an antimatter universe, a theory of physics not available before the development of hadronic mechanics. Accordingly, there was no mystery that grand unification became out of reach for standard physics restricted to quantum mechanics and Einstein relativity theory. From this approach

Santilli argued that grand unification was possible only as recognizing the quest as two connected grand unifications, one for the matter universe and one for the antimatter universe, to become integrated in a combined grand unification, and accordingly coined Iso-Grand-Unification, requiring isomathematics for its fulfillment.

Differently from 20th century standard physics, hadronic mechanics has provided a general scientific umbrella, sophisticated, abstract and broad enough to encompass life in its extension, at least in a much more emphatic and radical sense. This is intimately connected to the structure of the higher landscapes of hadronic mathematics, to be considered not only as tools but as structures complex enough to offer adequate maps of life's phenomena. Due to the lack of isonumbers required to describe hadronic superconductivity, quantum mechanics was never able to catalyze much progress in chemistry, with growing disconnection between physics and chemistry as a result. For mappings of biological structures, genonumbers become crucial to grasp the fundamental irreversibility characterizing the complexity of the biological world (as well as already the behavior of stars, galaxies and quasars). After a lifting to genostructures, the whole field of isostructures, which still implied reversibility in its basic mathematical axioms, reappears only as the subfield of genostructures where reversibility constitutes a special case. The further lifting from genostructures to the much broader hyperstructures achieves not only irreversibility, but the multi-valued theory required to map even more complex structures of life. Santilli notes that when described as a multi-valued hyperstructure, the same seashell can overlap a large number of spaces and their isoduals, resulting in multi-fold formulations including the four different directions of time. The relevance of hyperstructures to describe really complex life phenomena becomes perhaps most immediately and intuitively obvious if we move to psychology and reflects on the multi-fold dynamic constellation of mind spaces and time travels involved in ordinary human thinking.

This may indicate that the top floor in the huge building of hadronic mechanics, hypermechanics, is sophisticated enough to include also mental and social phenomena. In standard physics the quest for grand unification was restricted to a unification of the four conventional physical forces, silently regarding the mental and social worlds as mystically separated from the universe or as mere epi-phenomena mirroring or emerging from the four physical forces. On this background it is highly interesting that Santilli not only presents an (iso-)grand unification of the four forces in chapter 14 of the present volume, but takes the steps all the way up to a Hyper-Grand-Unification. In the modern development of science and society, the frontier of physics has always been highly influential indirectly on other disciplines, being regarded as the most authoritative discipline concerning what is to be stated with the highest degree of scientific certainty with respect to the basic issues of our cosmos. The rise of hadronic mechanics, with

the present volume presenting a systematic overview of its most mature achievements, constitutes a much more radical scientific revolution, since the argued fruits of hypermechanics are far from being relevant only for physics, but seems directly relevant for all scientific disciplines, and this in a profound manner.

Santilli notes that all distinctions between matter and antimatter are lost at the hyperstructural level and that at this highest possible level of formulation, we have one single hyperrelativity, one single Poincar-Santilli hypersymmetry (chapter 6.1.15). In this regard the advanced science of hypermechanics is in accord with the basic notion of cosmos being a unitary whole, characterizing great natur philosophy, such as Plotinus, Kant, Hegel and Bohm. Santilli also states: The foundation of our hypercosmology on the universal hypersymmetry is the single most important result of the authors lifetime of research because it governs the totality of the events in the universe (*ibid.*).

Being based on symmetry, the hypercosmology of hadronic mechanics differs from Einstein gravity and other preceding cosmologies of physics. The unitary whole of the cosmos is reflected in Santilli coining this cosmology hyper-self-dual, and Santilli explicitly states the necessity of lifting the cosmology from isotopic and genotopic theories to the hypertopic level because a basic component of the universe is life (chapter 14.2) which needs multi-valued descriptions to become comprehended.

In spite of the imagined universality of the hyper-self-dual cosmology and hyper-hadronic mechanics, Santilli is careful by stating that science will never admit a final theory. This humble attitude, the complementary polarity to the visionary extreme ambition also characterizing scientific genius, differs remarkably from physicists clinging to doctrines from Einstein relativity more like religious dogma and for eternity. This was an attitude quite alien to Einstein himself who published his break-through articles without one single reference to any authority (or non-authority), and let the power of thought speak for itself.

Santilli holds Einstein in very high esteem, and declares him explicitly as the greatest scientist of the last century. However, the admiration between deeply creative and thereby related minds seems to be of another kind than that between a genius and the later followers of his established authority. One might say that Santillis admiration of Einstein is more profound, insofar as the scientific thinking of Santilli himself exposes a similar brave, original and creative line of thought. From this also follows a scientific obligation to leave home if and when the pupil reaches far enough to explore unknown higher territories in the mountains of knowledge, climbing from the shoulders of his master. Santilli is careful in the present volume, as in earlier works, to pinpoint under which constraints Einstein relativity is still to be considered valid, and at the same time to state loud and clear why the masters theories do not hold when these constraints are abandoned, and therefore was in need of a more lifted and broader theory of physics which

Santilli went out to create through forty years of hard work. Considering all the experimental evidence from the 1990s on, showing beyond serious doubt that the light speed in vacuum does not represent any ultimate barrier for velocity, explained by hadronic mechanics as a necessity inside hyper-dense hadron media, it seems quite pathetic when the authority of Einstein is mobilized as rhetoric ammunition to obstruct such theory formation and recognition.

It has been said that the real masters greatest satisfaction is when he realizes that his pupil has grown beyond the skills of himself. If allowing such an analogy for the case of clarifying proportions, Einstein ought to have every reason to evaluate his pupil Santilli with delightful satisfaction. Like Einstein, Santilli has pushed the frontier of physics far beyond earlier imagination. However, unlike Einstein, Santilli has also pushed the frontier of the whole of physics, as well as the frontiers of whole disciplines outside physics foremost chemistry and mathematics, but also theoretical biology, and with direct implications also for other disciplines, among them philosophy. So, all in all, it seems hard to doubt that history will judge Santilli as an even greater genius than Einstein.

In the history of mankind there are very few examples of scientists showing brilliance both in mathematics (whether pure or applied to physics) and in the art of invention, the Norwegian Kristian Birkeland (1867-1917) constituting one of the few worth mentioning. With his amazing patents, as well as different types of constructed hadronic reactors producing the new chemical species of magneccules, Santilli has also proven extraordinary skills as an inventor, praised by Tesla as the foremost among sciences, as well as a laboratory man. These skills, indicating intuitively precise connectedness to the rock hard and dynamic physical world, ought to give further credibility to the practical and direct relevance of the theoretical physics and chemistry of Santilli, constituting a character quite different from the more ivory tower type of mathematical physicists.

The present volume may represent a suitable closing of Santillis pioneering monographs given to the world to whom it could concern as perhaps the richest collection of scientific goodies ever presented to Mankind, whose future may depend crucially on what it does with the treasures contained in this opus magnum. With this publication, serious scientists and scholars with open and critical minds across a plethora of disciplines have been given heavy loads of precious ideas to digest and cultivate for many a year to come. In spite of Santilli often using the expression young minds of all ages, the scientific presents are doomed to primarily become appetizers to consider for the younger and most emergent upcoming among those minds, because they will become the carriers and releasers of the future, if any. Besides the thrills of discovery in absorbing the monograph itself, as well as from explorative adventures fuelled by inspiration from it, there will also be a heavy load of social responsibility and dedicated action to carry out, considering signs of rising turbulence inside as well as outside science.

At Christmas time most people appreciate Santa Claus showing up to give them exclusive presents for delight. Sad to say, this is far from always being the situation in scientific communities, nor in society at large. Considering the immense obstacles to and antagonisms, be it brute or more sophisticated, against Santilli fulfilling his mission to science and to Mankind, it is quite a mystery in itself how this man has been able to keep on track, busily creating new insights with heroic energy and steady devotion seemingly greater than life, even after entering his eighth decade on the planet. The footnotes in this volume give some indication of the emotional challenge and burden involved therein, and tells of an intellectual honesty, integrity and boldness paradigmatic for any scientist, whatever degree of intelligence or idiosyncratic inclination.

Santilli holds the dream of humanity becoming able to harvest the huge clean energy connected to the beta-electron from neutron synthesis, predicted as a realistic possibility within reach from the physics of hadronic mechanics. At the same time, hadronic mechanics points out the missing energy in this synthesis when described by conventional physics, and locates the source of this energy gap to originate from the high energy density of the universal medium, by the way a statement similar to the avant-garde Russian physicist Kozyrev arguing the stars not to be fuelled by energy from their exterior. Whatever the destiny of this dream, it must be stated beyond doubt that the life work of Santilli represents quite a neutron synthesis in itself, fuelled from beyond the stars, with the present monograph constituting a new and clean hadronic energy of parachuting fruits from the tree of advanced and matured scientific knowledge, to be picked and eaten for the delight of the world. The release of this testament of Santillis science to the world ought to be honored with the uttermost gratitude and hungry attention. Science is nothing if not living science, so I find it irresponsible not to declare the historic proportions of the Santilli legacy, as to the best of my knowledge and judgment. Hence, on the possible behalf also of some future state of the affairs of the world and its science, I take the liberty to pass a 1001 thank you to the Great Italian - and may he stay forever young.

Professor Stein E. Johansen

PhD philosophy, DSc economics Institute for Basic Research, USA,

Division of Physics

Norwegian University of Science and Technology

Department of Social Anthropology

December 14, 2007

Index

- Lagrange equations, truncated, 8
- Newton-Santilli genoequations for matter, 343

- Action principle, 77
- Action-at-a-distance interactions, 277
- Aether, 280
- Aethereal wind, 281
- Algebra axioms, 13
- Anisotropy, 294
- Anti-Hydrogen atom, 149
- Antigravity, 277
- Antimatter, 1
- Antiparticles, 145
- Antiprotons, 149
- Associative law, 329
- Astrophysics, imbalance of, 52
- Attached algebras, 330

- Backward genocoordinates, 342
- Backward genospeed, 342
- Backward genotime, 342
- Backward genounit, 334
- Bilinear brackets, 329
- Bimodules, 339
- Binding energy, xiv
- Binding energy, positive, 283
- Binding energy, negative, 283
- Biology, xxiv, 369
- Biology, imbalance of, 53
- Birkhoff equations, 74
- Birkhoff brackets, 75
- Birkhoff tensor, 74
- Birkhoffian mechanics, insufficiencies of, 244
- Bistructure, 339
- Bose-Einstein fireball, 32
- Bose-Einstein correlation, xiv, 31
- Brackets Time evolution, 329

- Canonical tensor, 71
- Canonical transformations, 71
- Catastrophic inconsistencies, 332
- causality, 88
- Chaoticity parameters, xiv, 31
- Charge conjugation, 142
- Chemistry, insufficiency of, 38
- Classical genom mechanics, 98
- Classical hypermechanics, 100
- Classical isomechanics, 98
- Classical isomechanics, examples, 259
- Classical isomechanics, invariance of, 260
- Closed non-Hamiltonian systems, 161

- Cold fusion, 278
- Constancy speed of light, 285
- Construction Lie-admissible theories, 350
- Continuous creation, xv
- Coordinate genounit, 342
- Cosmology, xxvi
- Cosmology, imbalance of, 52
- Curvature, 64

- Darboux theorem, 12
- Deformed brackets, 83
- Deformed Hamilton equations, 83
- Deformed Hamilton's equations, 330
- deformed Heisenberg equation, 331
- Deformed Heisenberg equations, 85
- Dimensionless particles, 277
- Dirac equation, 139, 360
- Dirac equation, isoselfduality, 139
- Dirac equation, spin inconsistency, 139
- Dirac-Santilli genoequations, 362
- Dirac-Santilli isoequation, 298
- Direct universality, 86, 288, 332, 356
- Distributive law, 13
- Doppler-Santilli forward hyperlaw, 376
- Dunning-Davies Lie-admissible thermodynamics, 364
- Dunning-Davies thermodynamics, 133

- Einstein field equations, 58
- Einstein special relativity, 281
- Electromagnetic interactions, 360
- Electron, 282, 283
- Electrons, 149
- Energy equivalence, 52
- Energy isoequivalence, 297
- Energy nonconservation, 331
- Ether, 280
- Ethereal wind, 281
- Euclid-Santilli genospace, 343
- Euclid-Santilli isodual genospace, 343
- Extended, nonspherical, deformable shapes, 164
- Exterior dynamical problems, 7
- Exterior isogravity, 304
- External terms, insufficiencies, 243
- Extraterrestrial life, 284

- Feynman diagrams limitations, 5
- Forward genocoordinates, 342
- Forward genospeed, 342
- Forward genotime, 342

- Forward genounit, 334
- Forward hypercontraction, 376
- Forward hyperdilation, 376
- Forward hyperenergy, 376
- Forward hypermass, 376
- Forward hyperspeed, 376
- Four time directions, 119
- Freud identity, 63

- Galileo symmetry, dimension of, 185
- Galileo symmetry, inapplicability of, 18
- Galileo-Roman boosts, 318
- Galileo-Roman relativity, 317
- Galileo-Roman symmetry, 317
- Galileo-Roman time translation, 318
- Galileo-Santilli isodual relativity, 125
- General relativity, xxv, 277
- General relativity, inconsistencies of, 54
- Geno-Minkowskian geometry, 362
- Geno-Riemannian geometry, 362
- Genoaction principle, 345
- Genocoordinates, 342
- Genodifferential calculus, xxvii
- Genoexpectation values, 348
- Genofields, 335
- Genofunctional analysis, 335
- Genogeometries, 337
- Genomechanics, 98
- Genomomentum, 348
- Genonumbers, 335
- Genoproducts, 333
- genorelativity, 280
- Genospacetime, 362
- Genospeed, 342
- Genosymmetries, 339
- Genotime, 342
- Genotopic liftings, 280
- Genotopies, 280
- Genounits, 333
- Geometric locomotion, 362
- Grand Unifications, 2
- Grand unified theories, 363
- Gravitational source, 56

- Hadronic chemistry, xix
- Hadronic energies, xvii
- Hadronic genomechanics, 347
- Hadronic isodual genomechanics, 347
- Hadronic mechanic s, fundamental assumption, 168
- Hadronic mechanics, xvi, 97
- Hadronic mechanics, classification, 98
- Hadronic mechanics, invariance of, 276
- Hadronic mechanics, simple construction of, 274
- Hadronic mechanics, universality of, 268
- Hadrons, xiv

- Hamilton equations, true, 9, 242
- Hamilton equations, truncated, 8, 241
- Hamilton true equations, 158
- Hamilton's legacy, 327, 328
- Hamilton-Jacobi-Santilli equations, 262
- Hamilton-Jacobi-Santilli genoequations, 345
- Hamilton-Santilli genomechanics, 344
- Hamilton-Santilli isodual equations, 124
- Hamilton-Santilli isodual genomechanics, 344
- Hamilton-Santilli isoequations, 254
- Hamilton-Santilli isomechanics, 251
- Hamiltonian, 327
- Hamiltonian mechanics, 98
- Hamiltonian theory, 277
- Heisenberg
 - equation, 275
- Heisenberg equations, 332
- Heisenberg-Santilli genoequations, xvi, 348
- Heisenberg-Santilli isodual equations, 139
- Heisenberg-Santilli isodual genoequations, 348
- Heisenberg-Santilli isoequations, xvi, 267
- Hot fusion, 278
- Hydrogen atom, 149
- Hydrogen molecule, 38
- Hyperalgebras, 373
- Hyperaxioms, 376
- Hyperbeta, 377
- Hypercoordinates, 374
- Hyperdifferential calculus, 373
- hyperdifferential calculus, xxvii
- Hyperfunctional analysis, 373
- hypergamma, 377
- Hyperinterval, 375
- Hypermechanics, 100, 372
- Hyperproduct to the left, 372
- Hyperproduct to the right, 372
- Hyperspaces, 373
- Hyperstructures, 371
- hyperstructures, xxiv
- Hypertimes, 374

- Inconsistency theorem, classical, 76
- Inconsistency theorems, operator, 86
- Inconsistent theories, 90
- Index of refraction, 285
- Inertia, 282
- Inhomogeneity, 294
- Integravity conditions for a potential, 161
- Interior dynamical problems, 7
- Interior isogravity, 304
- Invariance Lie-admissible theories, 352
- Irreversibility, 49
- Irreversible systems, 280, 325
- Iso-Einstein isotensor, 215
- Iso-Euclidean box, 203
- Iso-Euclidean geometry, 202
- Iso-Freud- isoidentity, 216

- Iso-hamiltonian, 265
- Iso-Heisenberg equations, 267
- Iso-Hilbert spaces, 263, 266
- Iso-Minkowskian cube, 211
- Iso-operations, 176
- Iso-Pitagorean theorem, 190
- Iso-Ricci lemma, 215
- Iso-Schrödinger equations, 268
- Isoaberration, 296
- Isoacceleration, 249
- Isoaction principle, 251
- Isoaxisoms, 295
- Isocanonical one-isoform, 224
- Isocanonical two-isoform, 224
- Isocanoninity, 227
- Isocoordinates, 249, 288
- Isocovariant isodifferential, 214
- Isoderivative, 192
- Isodeterminant, 187
- Isodifferential, 192
- Isodifferential calculus, xxvii, 192
- Isodual isodifferential calculus, 192
- Isodual backward genocoordinates, 342
- Isodual backward genospeed, 342
- Isodual backward genotime, 342
- Isodual box, 129
- Isodual classical genomechanics, 98
- Isodual classical hypermechanics, 100
- Isodual classical isomechanics, 98
- Isodual complex numbers, 109
- Isodual coordinate genounits, 342
- Isodual Coulomb law, 120
- Isodual curvature tensor, 115
- Isodual derivative, 112
- Isodual differential, 112
- Isodual differential calculus, 111
- Isodual distance, 114
- Isodual electron, 145
- Isodual electrons, 149
- Isodual Euclidean geometry, 113
- Isodual Euclidean metric, 114
- Isodual exponentiation, 111
- Isodual field equations, 134
- isodual field equations, 143
- Isodual fields, 107
- Isodual forward genocoordinates, 342
- isodual forward genospeed, 342
- Isodual forward genotime, 342
- Isodual functional analysis, 111
- Isodual Galilean relativity, 125
- isodual general relativity, 134
- Isodual genoaction principle, 345
- Isodual genocoordinates, 342
- Isodual genoexpectation values, 348
- Isodual genofields, 335
- Isodual genofunctional analysis, 335
- Isodual genogeometries, 337
- isodual genomechanics, 98
- Isodual genomomentum, 348
- Isodual genonumbers, 335
- Isodual genospeed, 342
- Isodual genotime, 342
- Isodual genounits, 334
- Isodual Hamiltonian mechanics, 98, 124
- Isodual Heisenberg equations, 139
- Isodual Hilbert spaces, 136
- Isodual Hydrogen atom, 149
- Isodual hyperaxioms, 376
- Isodual hyperbolic functions, 111
- Isodual hypermathematics, 374
- Isodual hypermechanics, 100
- Isodual hypernumbers, 374
- Isodual hyperspaces, 374
- Isodual hyperunits, 374
- Isodual iso-Hilbert spaces, 263
- Isodual iso-operations, 176
- Isodual isofields, 175
- Isodual isofunctional analysis, 186
- Isodual isoinner product, 263
- Isodual isoperturbation theory, 272
- Isodual isoproduct, 171
- Isodual isoquantization, 262
- Isodual isorelativistic hadronic mechanics, 299
- Isodual isorelativity, 280
- Isodual isospaces, 182
- Isodual isostates, 263
- Isodual isosymplectic isogeometry, 223
- Isodual isotopology, 199
- Isodual isounit, 171
- Isodual Lagrangian mechanics, 123
- Isodual light cone, 129
- Isodual light speed, 130
- Isodual mathematics, 107
- Isodual Minkowskian geometry, 115
- Isodual Minkowskian metric, 115
- Isodual neutron, 145
- Isodual Newton equations, 121
- Isodual Newtonian mechanics, 121
- Isodual norm, 109
- Isodual numbers, 107
- Isodual operator genomechanics, 98
- Isodual operator hypermechanics, 100
- Isodual operator isomechanics, 98, 265
- Isodual operator Lie-isotopic mechanics, 261
- Isodual particles, 145
- Isodual photons, 147
- Isodual Poincaré symmetry, 129
- Isodual power, 109
- Isodual product, 107
- isodual proton, 145
- isodual protons, 149
- Isodual quantization, 136
- Isodual quantum mechanics, 98
- Isodual quotient, 109

- Isodual real numbers, 109
- Isodual Riemannian geometry, 115
- Isodual Riemannian space, 116
- Isodual Schrödinger equation, 138
- isodual spacetime inversions, 131
- Isodual special relativity, xxii, 128
- Isodual sphere, 114
- Isodual square root, 109
- Isodual theory of antiparticles, 118
- Isodual time, 119
- Isodual trigonometric functions, 111
- Isodual unit, 107
- Isoduality, 142
- Isoduas iso-Euclidean geometry, 202
- Isoexpectation values, 264
- Isofield, 266
- Isofields, 175
- Isoflatness isotensor, 215
- Isofunctional analysis, 186
- Isofunctions, 187
- Isogamma matrices, 298
- Isogravitation, 300
- isoheisenberg
 - equation, 275
- isohilbert space, 263
- Isinner product, 263
- Isinvariant, 288
- Isolinear isomom,entum, 268
- Isolinear momentum, 196
- Isolinearity, 227
- Isolocality, 227
- Isomechanics, 98
- Isoperturbation theory, 272
- isoperturbation theory, 273
- Isoproduct, 171, 266
- Isoquantization, 262
- Isorelativistic addition of isospeeds, 296
- Isorelativistic hadronic mechanics, 298
- Isorelativity, 277, 280
- Isorepresentation theory, 237
- Isorotations, 290
- Isoselfdual states, 151
- Isoselfdual symmetry, 110
- Isoselfduality, 138
- Isospaces, 182
- Isospeed, 249
- Isosphere, 291
- Isostates, 263
- Isosymmetries, fundamental theorem, 240
- Isosymplectic geometry, 223
- Isotime, 249
- isotopic
 - element, 259, 271, 273
- Isotopic isoscaler, 215
- Isotopic transformations, 293
- Isotopology, 199, 307
- Isotrace, 187
- Isotranslations, 292
- Isotriangle, 190
- Isotrigonometric functions, 188
- Isounit, 171, 266, 287
- isounit, 264
- Isounitariness, 227
- isounitary, 264
- Isovector isofield, 224
- Isowave equations, 298

- Jordan admissible, 330
- Jordan admissible algebras, 83
- Jordan algebras, 330
- Jordan-admissible, 88
- Jpiter interior problem, 158

- Kadeisvili isocontinuity, 197
- Keplerian nucleus, 19
- Keplerian systems, 19

- Lagrange equations, true, 9, 242
- Lagrange equations, truncated, 241
- Lagrange true equations, 158
- Lagrange's legacy, 327, 328
- Lagrange-Santilli isodual equations, 123
- Lagrangian, 327
- Lagrangian theory, 277
- Lie algebra axioms, 14
- Lie algebra loss, 13
- Lie Algebras, xvi
- Lie algebras, 330
- Lie algebras unification, 238
- Lie brackets, 71
- Lie tensor, 71
- Lie-admissible, 88
- Lie-admissible algebras, xvi, 83, 330
- Lie-admissible brackets, 330
- Lie-admissible genogroup, 355
- Lie-admissible spin, 358
- Lie-isotopic branch, 157
- Lie-Koenig theorem, 12
- Lie-Santilli
 - isothory, 266
- Lie-Santilli brackets, classical, 256
- Lie-Santilli hypertheory, 372
- Lie-Santilli isoalgebras, 233
- Lie-Santilli isodual isothory, 237
- Lie-Santilli isodual theory, 112
- Lie-Santilli isogroups, 234
- Lie-Santilli isothory, 266
- Lifting, xxiv, 328
- Light bending, 58
- Light hyperspeed, 378
- Light isocone, 212, 292
- Light speed, 52
- Longitudinal wave, 280
- Lorentz-Santilli genotransformations, 362

- Lorentz-Santilli isosymmetry, xvii, 289
- Magnegas, xix
- Magnetic moments deviations, 33
- Mass, 282
- Mass isovariation, 296
- Mass operator, 319
- Maximal causal isospeed, 295
- Metric isospaces, 183
- Minkowski-Santilli genogeometry, 337
- Minkowski-Santilli genospace, 337, 361
- Minkowski-Santilli hyperspace, 375
- Minkowski-Santilli hyperspacetimes, 375
- Minkowski-Santilli isodual genogeometry, 337
- Minkowski-Santilli isodual genospace, 337
- Minkowski-Santilli isodual isogeometry, 207
- Minkowski-Santilli isodual isospace, 207
- Minkowski-Santilli isogeometry, 207
- Minkowski-Santilli isogeometry, five identifies
of, 216
- Minkowski-Santilli isospace, 207
- Multi-dimensional, 370
- Multi-valued hyperunits, 372
- Negative energies, 153, 284
- Negative unit, 3
- Neutrino conjectures, 24
- Neutron, 283
- Neutron structure, 363
- New clean energies, 365
- New energies, 326
- Newton's equations, xxvi, 8, 327
- Newton's legacy, 327, 328
- Newton-Santilli genoequations, xxvii, 341
- Newton-Santilli hyperequations, xxvii
- Newton-Santilli isodual equations, 121
- Newton-Santilli isodual genoequations, 341
- Newton-Santilli isodual genoequations for anti-
matter, 343
- Newton-Santilli isodual isomechanics, 246
- Newton-Santilli isoequations, xxvii, 250
- Newton-Santilli isomechanics, 246
- No reduction theorems, 277
- Nonassociative algebras, 330
- Noncanonical theories, 70
- Noncanonical transform, 158
- Nonconservation laws, 339
- Nonkeplerian systems, 19
- Nonlinear theories, 91
- Nonlocal interactions, 5
- Nonlocal, nonlinear, nonpotential forces, 165
nonpotential
interactions, 267, 271
- Nonpotential forces, 75
- Nonunitary theories, 70
- Nonunitary transform, 82, 158
- Nuclear Force, insufficiency of, 36
- Nuclear Physics imbalance, 33
- Observable, 329
- Operator Lie-isotomic mechanics, 261
- Operator genomechanics, 98
- Operator hypermechanics, 100
- Operator isomechanics, 98, 265
- Operator isomechanics, invariance of, 276
- Operator isomechanics, simple construction of,
274
- Operator Lie-admissible equations, 332
- p-q-deformations, 83
- Parametric Lie-admissible equations, 331
- Particle experiment manipulations, 30
- Pauli principle, 359
- Pauli-Santilli genomatrices, 359
- Phase space, 71, 329
- Photons, 147, 281
- Physical media, 16
- Poinc e-Santilli isosymmetry, xvii
- Poincar e symmetry, dimension of, 185
- Poincar e symmetry, inapplicability of, 18
- Poincar e-Birkhoff-Witt-Santilli isothorem, 231
- Poincar e-Santilli hypersymmetry, 376
- Poincar e-Santilli isodual symmetry, 129
- Poincar e-Santilli isosymmetry, 289
- Point-like abstractions, 5
- Point-like antiparticles, 118
- Point-like particles, 277
- Poisson brackets, 71
- Position operator, 319
- Positive energies, 284
- Positronium, 151
- Positrons, 149
- Proton, 283
- Protons, 149
- q-deformations, 83
- Quantum chemistry, xvii
- Quantum electrodynamics, 62
- Quantum mechanics, xiii, 5, 98
- Quantum mechanics, limitations of, 46
- Quark conjectures, 21
- Reference frame, 281
- Relativistic Galilean boosts, 318
- Relativistic position operator, 319
- Relativistic sum violation, 16
- Representation isospace, 249
- Reversibility, 49
- Reversible systems, 278, 325
- Riemann-Santilli genogeometry, 338
- Riemann-Santilli isodual genogeometry, 338
- Santilli genodifferential calculus, xxiv
- Santilli genomathematics, xxiii, 333, 334

- Santilli genorelativity, xxiii, 280
- Santilli genounits, 334
- Santilli hyperdifferential calculus, xxiv
- Santilli hypermathematics, xxiv, 371
- Santilli hypermechanics, 371
- Santilli hyperrelativity, 375
- Santilli isodifferential calculus, xxiv
- Santilli isodual genomathematics, xxiii, 333
- Santilli isodual genorelativity, xxiv
- Santilli isodual hypermathematics, xxiv, 374
- Santilli isodual hypermechanics, 374
- Santilli isodual hyperrelativity, 375
- Santilli isodual isomathematics, xxiii
- Santilli isodual isonumbers, 175
- Santilli isodual isorelativity, xxiii, 280
- Santilli isodual Lie-admissible theory, 338
- Santilli isodual mathematics, xxii
- Santilli isogravitation, 300
- Santilli isomathematics, xxiii, 171
- Santilli isonumbers, 175
- Santilli isorelativity, xvii, xxiii, 277, 280
- Santilli isounit, 168
- Santilli Lie-admissible equations, 85
- Santilli Lie-admissible theory, 338
- Santilli magnecoles, xx
- Scalar law, 13, 329
- Schrödinger
 - equation, 262
- Schrödinger-Santilli isoequations, 268
- Schrödinger-Santilli genoequations, 348
- Schrödinger-Santilli isodual genoequations, 348
- Schrodinger-Santilli isodual equations, 138
- Screened Coulomb law, 43
- SETI, 284
- Space, xv, 280
- Space hyperunits, 374
- Space isocontraction, 296
- Spacetime hypercoordinates, 375
- Spacetime locomotion, 285
- Special relativity, xx, 5, 277, 281
- Special relativity limitations, 1
- Special relativity, consistency of, 55
- Special relativity, inapplicability of, 15, 16, 32
- Speed genounit, 342
- Speed isodual genounits, 342
- Speed of light, 285
- Strong interactions, 360
- Structurally irreversible, 280
- Structurally reversible, 278
- SU(3)-color classification, 360
- Submerged arcs, 46
- Substratum, xv
- Superconductivity, insufficiency of, 37
- Superluminal speeds, 18
- Symplectic structure, 71
- Theorem of catastrophic inconsistencies, 333
- Thermodynamics, 363
- Thermodynamics first law, 364
- Tim rate of variation, 339
- Time evolution brackets, 14
- Time genounit, 342
- Time hyperunits, 374
- Time isodilation, 296
- Time isodual genounit, 342
- Total conservation laws, 162
- Total isofields, 249
- Total isounit, 249
- Totally antisymmetric brackets, 330
- Totally symmetric brackets, 330
- Transversal wave, 281
- Truncated analytic equations, 327
- Truncated Hamilton's equations, 327
- Truncated Lagrange's equations, 327
- TSSFN isotopology, 307
- Two points function, 31
- Unit, 287
- Unitary transform, 333
- Universal isoenvolving algebra, 305
- Universal length, 319
- Universal substratum, 280
- Universality, 288, 356
- Universality of Lie-admissibility, 339
- Vacuum, xv, 280, 285
- Variational nonselfadjoint forces, 9, 161
- Variational nonselfadjointness, 327
- Variational selfadjoint forces, 9, 161
- Variational selfadjointness, 327
- Variationally nonselfadjoint, 327
- variationally selfadjoint, 327
- Velence bond, 294
- Wave overlapping, 167
- Wavepacket overlapping, 5
- Weak operations, 371